



**Technical
Catalogue**

two thousand
23-24



TECHNICAL CATALOGUE 2023-2024



FILMOP INTERNATIONAL PRIMARY GOAL IS TO DESIGN AND CREATE THE BEST CLEANING SYSTEMS IN THE FULL RESPECT FOR THE ENVIRONMENT.



A world leader Italian company in the professional cleaning market

Filmop International was founded in the early 70s as a company specialized in the **design and production of manual cleaning equipment** for professional use.

The **33,000-square-meter plant** located in northeastern Italy was joined by a **French distribution branch** in 1997 and an **American branch** in 2004, strengthening the company's presence in their respective markets.

Proud to spread "**Made in Italy**" around the world, today Filmop International **exports to more than 80 countries** with the utmost speed, reliability and efficiency.

Mission

Filmop International has always been inspired by the following main principles, that are surely behind its growth and development:

- a strong push for **innovation** and **research**
- a constant **attention towards customer's satisfaction**
- unequalled **production flexibility**
- a considerable **quick order processing**

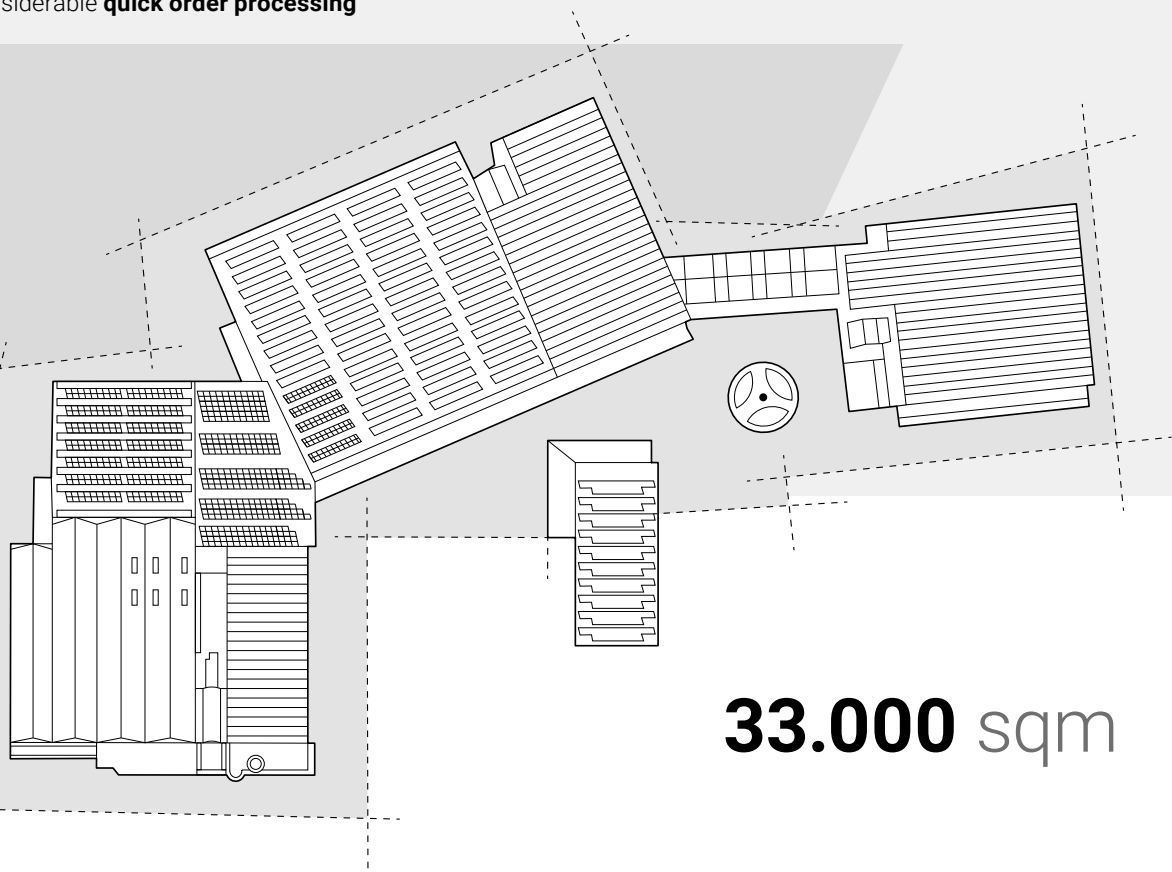



FILMOP INTERNATIONAL IS A TRUSTED PARTNER TOTALLY ORIENTED
TOWARDS CUSTOMER'S SATISFACTION



Your trusted partner

Those choosing Filmop International know they can rely on a **qualified partner**, organized to ensure **prompt order processing with fast and on-time deliveries**.

The company also stands out for its great **production flexibility**: each new customer request receives an immediate and careful analysis by the technical office to identify and develop the best possible solution.

Pre- and after-sales service helps in choosing the most appropriate cleaning system for specific needs, supporting the customer with on-site training and site inspections.

Finally, Filmop International provides a range of **marketing tools** aimed at increasing the depth of the range of products and systems offered:

- **web site** with detailed and constantly updated information
- freely accessible **catalogs and product sheets**
- **FilmopTalk online magazine** with industry articles and interviews
- **You Tube and Vimeo channels** with videos and tutorials
- **Alpha Configurator app** to design customized trolleys





FILMOP INTERNATIONAL HAS DEVELOPED SKILLS TO ACHIEVE HIGH BUSINESS AND PRODUCT STANDARDS

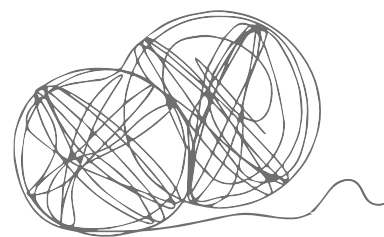

The certifications of Filmop International

The quality of the products and services offered by the company is guaranteed by the following certifications:

- **2000 | Quality Certification UNI EN ISO 9001:2015:** Filmop bases its growth on an organized business system with efficient management, suitable facilities and adequate skills
- **2011 | Environmental certification UNI EN ISO 14001:2015:** Filmop has chosen to implement an environmental management system to control the impacts of its activities on the ecosystem
- **2012 | Second Life Plastics:** Filmop offers a wide range of trolleys, bins and buckets with components made using recycled plastics
- **2015 | EU Ecolabel:** Filmop has obtained for many cloths, mops, flat mops and kentucky mops the eco-label that rewards the best environmentally sustainable products by qualifying them on the market
- **2022 | Carbon Footprint Systematic Approach:** Filmop has obtained the certification of the system for calculating the climate footprint of the trolleys, carried out in accordance with UNI EN ISO 14067:2018

The company fulfills its obligations under European Regulation **REACH**: it purchases raw materials from trusted and qualified suppliers, who declare that they comply with current supply chain regulations.

Finally, it meets the criteria of **BRC**, a structured management system for hygiene control and product safety.



Certification
ISO **9001**



Certification
ISO **14001**

Fulfillment of obligations
under the European **REACH**
regulation

A successful range of products

For Filmop International, being successful means being able to **understand, read and be ahead of market needs**. This aptitude has led it to take a **leading role** in the process of change that has affected the professional cleaning industry over the past three decades.

In particular, Filmop International was the first Italian manufacturing company with a special attention to:

- in the importance of **alternative materials to metal** such as polypropylene, which is strong, lightweight and totally recyclable
- in the need for **separation of clean water from rinse water** as a basic prerequisite for professional cleaning
- in the value of **ergonomic cleaning systems** that can improve operators' working conditions

These three concepts are the main pillars of a successful business and production policy, that has led to a complete range of products for professional cleaning with **more than 4.000 finished items**.





FILMOP INTERNATIONAL'S CONTRIBUTION TOWARD SUSTAINABLE DEVELOPMENT IS REALIZED IN ITS COMMITMENT TO ENVIRONMENTAL PROTECTION

Equodose® adjustable dispenser to save cleaning solution



AlphaSplit System to facilitate separate waste collection



Commitment to sustainable development

In an age in which the preservation of our environment is the world top priority, Filmop International is strongly engaged and oriented towards a policy of sustainable development.

Since its origins, the company has followed a **precise path toward eco-sustainability** that has enabled it to achieve important results over time:

- Corporate and product **environmental certifications**
- Selection of qualified suppliers according to the **European REACH Regulation**
- Use of **raw materials of recycled origin**
- Development of **products and systems with low environmental impact**
- Products made from separable materials and thus **recyclable at end of life**
- **Energy self-sufficiency** through photovoltaic system
- Efficient organization of the **separate waste collection and leftovers**



Wide range of high performance dTex ≤ 1 microfibers



Products with Plastic
Second Life certified
components

THE LAST **GREEN**
MILESTONE ACHIEVED



CO₂
Carbon footprint



Certification of the Carbon Footprint Systematic Approach

Filmop International has decided to keep on its path toward eco-sustainability by taking a further step forward: extensive analysis, planning and development work has enabled the company to implement a **system for quantifying Product Carbon Footprint** based on a systematic approach.

The work done was recognized by an independent, accredited verification company that **certified the implemented system** after carrying out a detailed evaluation.

Through the Carbon Footprint Systematic Approach, Filmop International can **calculate the climate footprint of the entire range of trolleys**, from buckets and mop trolleys to multi-purpose and service trolleys.

Counting of **CO₂e** is done for **every phase of the product life cycle**: from raw material sourcing to production, through transport and consumer use to end-of-life disposal.

DETECTING THE CLIMATE FOOTPRINT OF
PRODUCTS AND TURNING IT INTO OBJECTIVE
DATA ENABLES SPECIFIC ACTIONS TO BE
IMPLEMENTED TO PROMOTE SUSTAINABLE
DEVELOPMENT





CHOOSE PRODUCTS WITH
ENVIRONMENTAL
CERTIFICATIONS: A
RESPONSIBLE CHOICE TO
PROTECT THE ENVIRONMENT

Plastic Second Life

Filmop International is the first Italian company in the cleaning equipment sector to have obtained **Plastic Second Life** certification, the first **European label dedicated to recycled plastics** created to guarantee and easily identify goods made using recycled plastics.

Filmop offers several lines of **trolleys, bins and buckets** with components made with significantly higher percentages of PSV polypropylene than the minimum required, while maintaining original colors and the same quality.

The certified product lines

EU Ecolabel

Filmop International has obtained for many **cloths, mops, flat mops and kentucky mops** the prestigious **EU Ecolabel** certification, the **European Union's ecolabel** that rewards the best environmentally sustainable products.

The certification attests to the low environmental impact of products after analyzing their sustainability throughout their life cycle through a very selective set of parameters established by the European Community.

The full range of EU Ecolabel-certified products is available in the European ECAT registry:

<http://ec.europa.eu/ecat/products/en/22016/n-a>



The logo for "plastic second life MIX ECO" features a stylized blue circular graphic on the left, followed by the word "plastic" in a large, green, lowercase font. Below "plastic" are the words "second life" in a smaller, green, lowercase font, and "MIX ECO" in a blue, uppercase font at the bottom.



WITH ALPHA CONFIGURATOR YOU CAN ENJOY DESIGNING A CUSTOMIZED CLEANING TROLLEY



Pc



iPad



Tablet

Your ideal trolley with a click

Alpha Configurator is Filmop International's application that allows you to **create in a few simple steps a customized trolley**, configured according to your specific needs: you can freely choose the number of units, washing systems, doors, accessories, colors and more, thus creating the ideal trolley for every cleaning need.

The **3D version for PC, tablet and iPad** allows you to **customize the trolleys in every detail**: the many combinations offered and the wide range of products and accessories available, including the latest news, make the configuration possibilities endless.





FILMOP INTERNATIONAL GUARANTEES QUALITY PRODUCTS, THE RESULT OF CAREFUL RESEARCH AND SELECTION OF RAW MATERIALS



Washing temperature



Cold water washing



Hand washing



No chlorine-based bleach during



Low temperature drying



No ironing



Do not dry clean



No drying-chamber

Maintenance and care of textile products

To keep performance unchanged over time and help extend the life cycle as much as possible, please pay special attention to the **washing instructions** below:

- Follow carefully the washing instructions and warnings on the detergent packaging (temperature and dosing) before washing
- Always pre-wash microfiber mops in cold water without detergent to remove residues of the chemical solution
- We recommend the use of normal detergent for textiles, no fabric softener
- We suggest to use the specific net bags for the mop washing
- Do not use chlorine or bleach
- Do not use softener
- Use alkaline detergents with Ph <11

For more details **see the product data sheets**, which can be freely downloaded from the website www.filmop.com.



General safety of plastic, metal and mixed products

The items we market do not require product certification, as they correspond to the definition given in Legislative Decree 206 of 06.09.2005.

Based on such decree, a safe product is a product that during normal or reasonably predictable use, including in terms of duration, does not pose any hazards or only minimum hazards, compatible with the use of the product itself.

The items listed above are not within the scope of any of the European Product Directives, in particular they do not fall under the Machinery Directive 93/37/EC, the Low Voltage Directive 73/23/EC or the Electromagnetic Compatibility Directive 89/336/EEC.

Also, no specific risks connected with the cleaning items or systems of relevance have been identified.

The material used are all materials which don't constitute a chemical health hazard to the end users

The company constantly monitors the materials used, keeping their safety data sheets on file.

As far as safety is concerned, it must be pointed out that the product may not be used by non-professional users, or on non-level surfaces with slopes exceeding 1%.

It is also recommended that the items are stored away from the reach of children.

Lastly, the company shall not be held responsible for any damage caused by the substances used by operators.

Safety of electric items and motor-driven trolleys

Our electric items - Aura range - meet the 89/336/EEC Electromagnetic Compatibility Directive and are all CE marked.

Our motor-driven trolleys meet the essential safety requirements of Attached I of the 2006/42/EC Machine Directive, the requirements of the 2014/35/EU Low Voltage Directive and of the 89/336/EEC Electromagnetic Compatibility Directive.

Also as far as motor-driven trolleys:

- The **RISK** assessment has been completed in compliance with UNI EN 12100:2010
- The **MECHANICAL** hazard assessment has been completed in compliance with UNI EN ISO 14120
- The **ELECTRICAL** hazard assessment has been completed in compliance with IEC 60204

Before using electric items and motor-driven trolleys, the operator must read the instruction booklet, which must be strictly followed. For any doubts, the operator can refer to the Manufacturer or the available Support Centres.

The materials used for the manufacturing of electric items and motor-driven trolleys are all materials that do not pose any chemical hazards for the health of users. The company constantly monitors the materials used, keeping their safety data sheets on file.

However, the batteries of motor-driven trolleys must be treated in compliance with the instruction booklet provisions and instructions for their conservation and replacement.

Motor-driven trolleys must only be used for transporting cleaning materials and items, laundry and similar, and always by qualified professional personnel, meaning personnel trained by the employer on their use and the risks that such use may entail. All the provisions of the instruction booklet must be followed during use. It is also recommended that the items are stored away from the reach of children.

Lastly, the manufacturer shall not be held responsible for any damage caused by the operator using the electric items and the motor-driven trolleys.

Compliance Declaration

All items we market comply with current safety laws and are covered by a "product liability" **insurance policy**.

NEW New products index

Broom with handle 80 cm for Jobby dustpan



Page 40

Rilsan coated bucket holder for 10/20 liter buckets, to be applied at the base of Alpha trolleys



Page 114

Rubber blade for window squeegee, Filmop line



Page 120

Floor scraper with plastic grip



Page 48

Mesh bag with closing string



Page 114

ECO MULTI-T - multipurpose ultra-microfibre cloth



Page 134

Floor scraper with metal handle



Page 48

GLOSS-W - Stainless steel window squeegee



Page 119

BOOST - plastic flat wringer



Page 197

CLICK SAFE - plastic foldable mop holder



Page 73

Stainless steel grip for Gloss-W window squeegee



Page 119

ALPHA 0506702 - plastic trolley with Click Safe system



Page 251

Plastic lid for Click Safe system



Page 114

Stainless steel channel with rubber blade for window squeegee



Page 119

ALPHA 3806780 - plastic trolley with Click Safe system



Page 259

NEW New products index

ALPHA 0806732 - plastic trolley with Click Safe system



Page **262**

ATLAS - white plastic bin with swing lid



Page **342**

ALPHA 3806781 - plastic trolley with Click Safe system



Page **263**

ATLAS ECO - plastic grey bin with swing lid



Page **342**

ALPHA A-B PLUS 0603706 - antibacterial plastic trolley with Click Safe system



Page **329**

ATLAS FIT - plastic white bin with shaped lid for waste collection



Page **342**

ALPHA A-B PLUS 0803705 - antibacterial plastic trolley with Click Safe system



Page **330**

ATLAS PRESS - plastic white bin with lid and pedal



Page **341**

Floor care and dusting



Dust mopping

Damp mopping

Dustpans

Brooms and brushes

Equipment for wax application

Pad holders

Scrapers

Floor squeegees





- DUST MOPPING
- DAMP MOPPING
- DUSTPANS
- BROOMS AND BRUSHES
- EQUIPMENT FOR WAX APPLICATION
- PAD HOLDERS
- SCRAPERS
- FLOOR SQUEEGEES

Dust mopping with flat mops and the specific mop holders is the ideal system to collect and keep the dust, unlike the household brooms which just raise the dust to let it deposit on the floor again afterwards. Filmop dust mops are available in different sizes from 40 to 160 cm.

YARNS



Natural fiber coming from recycling with thin yarn that effectively removes the smallest particles of dust and dirt, ensuring excellent cleaning results.



100% COTTON



Natural mixed fiber coming from recycling with highly absorbent thick yarn that attracts, captures and keeps dirt, releasing it only during mop washing.



COTTON



Regenerated natural fiber coming from recycling with thin yarn ideal for dusting, as it collects and keeps effectively dust from any surface.



FIRST RATE

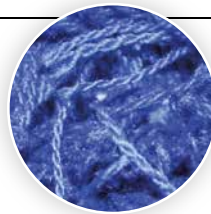

A high electrostatic charged fiber that collects and attracts dust particles, thus increasing the performances of the mop.



ACRYLIC



Microfiber is a synthetic fiber that penetrates into the microporosity of the floor, retaining the dirt removed and releasing it only during machine washing.



RAPIDO SUPER EXTRA



Please, refer to pages 18-19 for washing instructions.

KIND OF SUPPORT



Strings



Pockets



Buttons

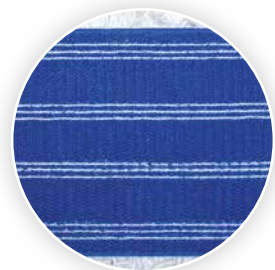

Strap tape system



- DUST MOPPING
- DAMP MOPPING
- DUSTPANS
- BROOMS AND BRUSHES
- EQUIPMENT FOR WAX APPLICATION
- PAD HOLDERS
- SCRAPERS
- FLOOR SQUEEGEES

Dust mops

100% cotton mop with buttons



REF.	NOTES	PCK	VOLUME (m³)	GROSS WEIGHT (kg)	SIZE (cm) ↓ ↓ ↓
5141		25	0,028	5,43	40x12
5161		25	0,043	7,33	60x12
5181		25	0,064	9,53	80x12
5111		25	0,083	11,72	100x12

100% cotton pocket mop



REF.	NOTES	PCK	VOLUME (m³)	GROSS WEIGHT (kg)	SIZE (cm) ↓ ↓ ↓
5141/1		25	0,024	4,42	40x12
5161/1		25	0,033	5,61	60x12
5181/1		25	0,052	7,2	80x12
5111/1		25	0,083	9,47	100x12

Normal cotton mop with buttons



REF.	NOTES	PCK	VOLUME (m³)	GROSS WEIGHT (kg)	SIZE (cm) ↓ ↓ ↓
5142		25	0,028	5,43	40x12
5162		25	0,043	7,58	60x12
5182		25	0,064	10,28	80x12
5112		25	0,083	12,22	100x12

Normal cotton pocket mop



REF.	NOTES	PCK	VOLUME (m³)	GROSS WEIGHT (kg)	SIZE (cm) ↓ ↓ ↓
5142/1		25	0,028	4,43	40x12
5162/1		25	0,033	6,36	60x12
5182/1		25	0,052	8,2	80x12
5112/1		25	0,083	10,47	100x12

Blue acrylic mop with buttons



REF.	NOTES	PCK	VOLUME (m³)	GROSS WEIGHT (kg)	SIZE (cm) ↓ ↓ ↓
5144		25	0,028	3,93	40x12
5164		25	0,043	6,08	60x12
5184		25	0,064	7,78	80x12
5114		25	0,083	9,22	100x12

Blue acrylic pocket mop



REF.	NOTES	PCK	VOLUME (m³)	GROSS WEIGHT (kg)	SIZE (cm) ↓ ↓ ↓
5144/1		25	0,028	3,18	40x12
5164/1		25	0,033	4,61	60x12
5184/1		25	0,052	5,95	80x12
5114/1		25	0,083	7,72	100x12

First rate cotton mop with polyester backing and strings



REF.	NOTES	PCK	VOLUME (m³)	GROSS WEIGHT (kg)	SIZE (cm) ↓ ↓ ↓
5746		25	0,028	5,43	40x12
5766		25	0,043	7,58	60x12
5786		25	0,064	10,03	80x12
5716		25	0,083	11,97	100x12



DUST MOPPING

DAMP MOPPING

DUSTPANS

BROOMS AND BRUSHES

EQUIPMENT FOR WAX APPLICATION

PAD HOLDERS

SCRAPERS

FLOOR SQUEEGEES

Blue acrylic mop with polyester backing and strings



REF.	NOTES	PCK	VOLUME (m³)	GROSS WEIGHT (kg)	SIZE (cm) ↓ ↓ ↓
5147		25	0,028	3,68	40x12
5167		25	0,043	5,33	60x12
5187		25	0,064	7,03	80x12
5117		25	0,083	8,47	100x12
5178/2		15	0,043	6,04	110x12
5128/2		15	0,043	6,13	120x12
5138/2		15	0,049	6,33	130x12
5158/2		15	0,064	7,68	160x12

100% cotton mop with polyester backing and strings



REF.	NOTES	PCK	VOLUME (m³)	GROSS WEIGHT (kg)	SIZE (cm) ↓ ↓ ↓
5176/2		15	0,043	7,93	110x12
5126/2		15	0,049	8,43	120x12
5136/2		15	0,049	9,03	130x12
5156/2		15	0,064	10,98	160x12

Set of 100% cotton V-sweeper mop with buttons



REF.	NOTES	PCK	VOLUME (m³)	GROSS WEIGHT (kg)	SIZE (cm) ↓ ↓ ↓
5101	for mop holder art. 5201 - 5201/1	12	0,083	11,77	100x12

Set of normal cotton V-sweeper mop with buttons



REF.	NOTES	PCK	VOLUME (m³)	GROSS WEIGHT (kg)	SIZE (cm) ↓ ↓ ↓
5102	for mop holder art. 5201 - 5201/1	12	0,083	12,01	100x12

Set of blue acrylic V-sweeper mop with buttons



REF.	NOTES	PCK	VOLUME (m³)	GROSS WEIGHT (kg)	SIZE (cm) ↓ ↓ ↓
5104	for mop holder art. 5201 - 5201/1	12	0,083	9,37	100x12

Set of first rate cotton V-sweeper mop with polyester backing and strings



REF.	NOTES	PCK	VOLUME (m³)	GROSS WEIGHT (kg)	SIZE (cm) ↓ ↓ ↓
5706	for mop holder art. 5201 - 5201/1	12	0,083	11,77	100x12

Set of blue acrylic V-sweeper mop with polyester backing and strings



REF.	NOTES	PCK	VOLUME (m³)	GROSS WEIGHT (kg)	SIZE (cm) ↓ ↓ ↓
5107	for mop holder art. 5201 - 5201/1	12	0,083	8,17	100x12



- DUST MOPPING
- DAMP MOPPING
- DUSTPANS
- BROOMS AND BRUSHES
- EQUIPMENT FOR WAX APPLICATION
- PAD HOLDERS
- SCRAPERS
- FLOOR SQUEEGEES

RAPIDO SUPER EXTRA - high-performing white microfiber mop for big areas, with backing for strap tape system

REF.	NOTES	PCK	VOLUME (m³)	GROSS WEIGHT (kg)	SIZE (cm) ↓ ↓ ↓
00PN0823A00DA	for mop holder art. 5201/28 and art. 5278	14	0,015	2,71	80x10
00PN1023A00DA	for mop holder art. 5201/21 and art. 5278	10	0,015	2,39	100x10



Ideal for industrial floors, natural stones, single-fired tiles and stoneware with a medium-high degree of dirt

Mop holders for dust mops

Foldable metal dust mop holder with metal joint

REF.	NOTES	PCK	VOLUME (m³)	GROSS WEIGHT (kg)	SIZE (cm) ↓ ↓ ↓
5241		25	0,028	9,53	40x9
5261		25	0,043	11,83	60x9
5281		25	0,064	15,03	80x9
5411		25	0,083	0,97	100x9
5211	reinforced	25	0,083	23,47	100x9



Foldable metal dust mop holder with plastic joint

REF.	NOTES	PCK	VOLUME (m³)	GROSS WEIGHT (kg)	SIZE (cm) ↓ ↓ ↓
5241/PA		25	0,035	8,99	40x9
5261/PA		25	0,049	11,38	60x9
5281/PA		25	0,064	14,53	80x9
5411/PA		25	0,083	14,64	100x9
5211/PA	reinforced	25	0,083	22,97	100x9



DUST MOPPING

DAMP MOPPING

DUSTPANS

BROOMS AND BRUSHES

EQUIPMENT FOR WAX APPLICATION

PAD HOLDERS

SCRAPERS

FLOOR SQUEEGEES

Foldable dust mop holder with plastic plate and joint

REF.	NOTES	PCK	VOLUME (m³)	GROSS WEIGHT (kg)	SIZE (cm) ↓ ↓ ↓
5341A		25	0,035	6,74	40x9
5361A		25	0,049	8,38	60x9
5381A		25	0,064	11,03	80x9
5511A		25	0,083	14,69	100x9
5311A	reinforced	25	0,083	17,22	100x9

Fixed plastic dust mop holder

REF.	NOTES	PCK	VOLUME (m³)	GROSS WEIGHT (kg)	SIZE (cm) ↓ ↓ ↓
5342H		25	0,035	6,04	40x9
5362H		25	0,049	9,53	60x9

Foldable plastic mop holder with pedal opening device

REF.	NOTES	PCK	VOLUME (m³)	GROSS WEIGHT (kg)	SIZE (cm) ↓ ↓ ↓
5540		15	0,028	3,6	40x9
5560		15	0,043	4,42	60x9



Mop holder for big areas

Fixed metal dust mop holder with two supports

REF.	NOTES	PCK	VOLUME (m³)	GROSS WEIGHT (kg)	SIZE (cm) ↓ ↓ ↓
5271		10	0,065	16,27	110x9
5221		10	0,065	17,33	120x9
5231		10	0,065	17,83	130x9
5251		10	0,074	18,47	160x9

Fixed metal dust mop holder with plastic joint

REF.	NOTES	PCK	VOLUME (m³)	GROSS WEIGHT (kg)	SIZE (cm) ↓ ↓ ↓
5271/PA		10	0,052	12,9	110x9
5221/PA		10	0,052	17,44	120x9
5231/PA		10	0,052	17,94	130x9
5251/PA		10	0,064	18,1	160x9





- DUST MOPPING
- DAMP MOPPING
- DUSTPANS
- BROOMS AND BRUSHES
- EQUIPMENT FOR WAX APPLICATION
- PAD HOLDERS
- SCRAPERS
- FLOOR SQUEEGEES

Wooden V-sweeper dust mop holder



REF.	NOTES	PCK	VOLUME (m³)	GROSS WEIGHT (kg)	SIZE (cm) ↓ ↓ ↓
5201		10	0,078	17,66	100x7

Metal V-sweeper dust mop holder



REF.	NOTES	PCK	VOLUME (m³)	GROSS WEIGHT (kg)	SIZE (cm) ↓ ↓ ↓
5201/1		10	0,062	21,39	100x9

Plastic V-sweeper mop holder with strap tape system



REF.	NOTES	PCK	VOLUME (m³)	GROSS WEIGHT (kg)	SIZE (cm) ↓ ↓ ↓
5201/28A		10	0,064	16,82	80x8
5201/21A		10	0,083	19,75	100x8

Chromed V-sweeper handle



REF.	NOTES	PCK	VOLUME (m³)	GROSS WEIGHT (kg)	SIZE (cm) ↓ ↓ ↓
5202		5	0,054	10,09	134



Chromed V-sweeper handle with central plastic reinforcement



REF.	NOTES	PCK	VOLUME (m³)	GROSS WEIGHT (kg)	SIZE (cm) ↓ ↓ ↓
5203		5	0,054	10,21	134



- DUST MOPPING
- DAMP MOPPING
- DUSTPANS
- BROOMS AND BRUSHES
- EQUIPMENT FOR WAX APPLICATION
- PAD HOLDERS
- SCRAPERS
- FLOOR SQUEEGEES

Articulated plastic connection with screws for V-sweeper handle art.5203

REF.	NOTES
5503	



Complete V-sweeper

Full V-sweeper mop with normal cotton mop with buttons, wooden plate and chromed handle



REF.	NOTES	PCK	VOLUME (m³)	GROSS WEIGHT (kg)
5002SL		5	0,116	18,15
05002		1	0,046	4,28

Full V-sweeper mop with normal cotton mop with buttons, iron plate and chromed handle



REF.	NOTES	PCK	VOLUME (m³)	GROSS WEIGHT (kg)
5002SF		5	0,111	24,45
05002SF		1	0,046	5,7



DUST MOPPING

DAMP MOPPING

DUSTPANS

BROOMS AND BRUSHES

EQUIPMENT FOR WAX APPLICATION

PAD HOLDERS

SCRAPERS

FLOOR SQUEEGEES

Damp mopping is very important because it allows to collect and keep also the smallest dust particles reducing micro-organisms in the air. Filmop offers mop holders with rubber blades or lamellas or mop holders with foam soles for pre-soaked cloths or cotton gauzes. The special trapezoidal shaped mop holders allow to clean edges and hard-to-reach areas, they are light and handy.

MOP HOLDERS WITH STRAP TAPE SYSTEM



Thanks to the wide range of accessories, like foam soles, mop and pads, the mop holders with strap tape system can be used for different cleaning operations.

CLOTH HOLDERS WITH RUBBER BLADES OR LAMELLAS



The 30° inclination of the flexible rubber blades allows to collect all dust particles assuring the utmost hygiene also on uneven floors. The cloth holders with rubber blades or lamellas are **washable** and **sterilizable**.

MOP HOLDER WITH FOAM SOLE



The mop holders with foam sole are light and practical, they are suitable also for uneven surfaces. Available in 2 versions: cloth holders with incorporated foam sole or cloth holder with strap tape system with removable foam sole

All Filmop mop holders can be equipped with **Lock System** that improves the cleaning of walls and ceilings just locking and unlocking the joint simply pushing up and down the special device using one's foot.



Unlocked joint:
floor cleaning



Locked joint:
cleaning of walls and ceilings

Cloth holder with rubber blades and with foam sole

SPARK - cloth holder with rubber blades



REF.	NOTES	PCK	VOLUME (m³)	GROSS WEIGHT (kg)	SIZE (cm) ↓ ↓ ↓
72000A		1	0,006	0,68	40x11
72001A		1	0,006	0,85	60x11
72002A		1	0,008	1,33	80x11

Autoclavable

SPARK - cloth holder with rubber blades, with Lock System



REF.	NOTES	PCK	VOLUME (m³)	GROSS WEIGHT (kg)	SIZE (cm) ↓ ↓ ↓
73000A		1	0,006	0,69	40x11

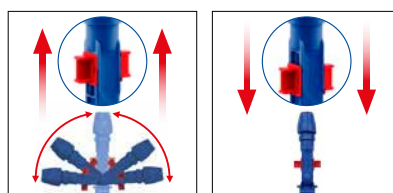

Autoclavable



DUST MOPPING

DAMP MOPPING

DUSTPANS

BROOMS AND BRUSHES

EQUIPMENT FOR WAX APPLICATION

PAD HOLDERS

SCRAPERS

FLOOR SQUEEGEES

SPARK - tool with rubber blades and ErgoSwing joint

REF.	NOTES	PCK	VOLUME (m³)	GROSS WEIGHT (kg)	SIZE (cm) ↓ ↓ ↓
79000A		1	0,006	0,72	40x11
79001A		1	0,006	0,9	60x11

 Autoclavable - use with ErgoSwing system handle, code 0000AM3045 - [Learn more about ErgoSwing in the handle section](#)
SPARK - cloth holder with rubber blades complete with chromed handle 140 cm - 2 pcs

REF.	NOTES	PCK	VOLUME (m³)	GROSS WEIGHT (kg)	SIZE (cm) ↓ ↓ ↓
172000A		1	0,008	1,08	40x11
172001A		1	0,008	1,73	60x11

FLEXY - cloth holder with rubber blades complete with chromed metal handle 140 cm - 2 pcs

REF.	NOTES	PCK	VOLUME (m³)	GROSS WEIGHT (kg)	SIZE (cm) ↓ ↓ ↓
5225A		1	0,008	1,63	60x11

Cloth holder with foam sole complete with chromed metal handle 140 cm - 2 pcs



REF.	NOTES	PCK	VOLUME (m³)	GROSS WEIGHT (kg)	SIZE (cm) ↓ ↓ ↓
5213A		1	0,008	1,2	40x11
5212A		1	0,008	1,31	60x11

Cloth holder with foam sole, no handle



REF.	NOTES	PCK	VOLUME (m³)	GROSS WEIGHT (kg)	SIZE (cm) ↓ ↓ ↓
100/5213A		10	0,028	3,97	40x11
100/5212A		10	0,043	5,08	60x11

Cloth holder with strap tape system and replaceable foam sole, complete with chromed handle 140 cm - 2 pcs



REF.	NOTES	PCK	VOLUME (m³)	GROSS WEIGHT (kg)	SIZE (cm) ↓ ↓ ↓
5254A		1	0,008	1,19	60x11



DUST MOPPING

DAMP MOPPING

DUSTPANS

BROOMS AND BRUSHES

EQUIPMENT FOR WAX APPLICATION

PAD HOLDERS

SCRAPERS

FLOOR SQUEEGEES

Rapido mop holders

RAPIDO - plastic holder with back fixing hooks



REF.	NOTES	PCK	VOLUME (m³)	GROSS WEIGHT (kg)	SIZE (cm) ↓ ↓ ↓
0000TA0001A		10	0,019	2,73	40x10

Pad for cloth holder with strap tape system



REF.	NOTES	PCK	VOLUME (m³)	GROSS WEIGHT (kg)	SIZE (cm) ↓ ↓ ↓
5224		25	0,019	0,84	40x11
5223		25	0,03	1,19	60x11

Components for holders with rubber blades and with foam sole

Plastic joint with articulation



REF.	NOTES
4008A	

Lock System plastic joint



REF.	NOTES
4028AB	

Round cloth star fixing clip



REF.	NOTES
60062U	

Autoclavable round cloth star fixing clip for Spark cloth holders



REF.	NOTES
P191061U	

Foam sole for cloth holder with strap tape system



REF.	NOTES	PCK	VOLUME (m³)	GROSS WEIGHT (kg)	SIZE (cm) ↓ ↓ ↓
5247		125	0,095	1,75	30
5239		25	0,028	1,18	40
5240		25	0,043	1,78	60



DUST MOPPING

DAMP MOPPING

DUSTPANS

BROOMS AND BRUSHES

EQUIPMENT FOR WAX APPLICATION

PAD HOLDERS

SCRAPERS

FLOOR SQUEEGEES

Cotton gauzes and cloths

Hemmed cotton gauze



REF.	NOTES	PCK	VOLUME (m ²)	GROSS WEIGHT (kg)	SIZE (cm) ↓ ↓ ↓
5215		200	0,057	10,94	60x80
5216		200	0,078	16,59	80x100
5219		100	0,05	10,27	80x120
5217		100	0,053	11,91	80x140
5214		50	0,05	8,2	80x180

Polybags with 10 pcs each for products no. 5215 and 5216 and polybags with 5 pcs each for products no. 5219-5217 and 5214.

Cotton gauze in roll h 80 cm



REF.	NOTES	PCK	VOLUME (m ²)	GROSS WEIGHT (kg)
5220	roll 100 mt long	100	0,03	7,6



White polypropylene disposable cloth soaked with mineral oil



REF.	NOTES	PCK	VOLUME (m ²)	GROSS WEIGHT (kg)	SIZE (cm) ↓ ↓ ↓
50002	pck.: 20 polybags with 50 pcs	1	0,023	3,3	20x60
50003	pck.: 20 polybags with 50 pcs	1	0,035	4,54	30x60
50011	pck.: 12 polybags with 50 pcs	1	0,024	2,44	20x85
50004	pck.: 40 polybags with 25 pcs	1	0,026	2,8	25x42

Viscose colored disposable cloth soaked with mineral oil



REF.	NOTES	PCK	VOLUME (m ²)	GROSS WEIGHT (kg)	SIZE (cm) ↓ ↓ ↓	
5206	pck.: 10 polybags with 50 pcs each		1	0,024	3,73	20x60
5210	pck.: 10 polybags with 50 pcs each		1	0,067	11,11	57x60

Disposable roll cloth made of polypropylene soaked with mineral oil



REF.	NOTES	PCK	VOLUME (m ²)	GROSS WEIGHT (kg)	SIZE (cm) ↓ ↓ ↓
0000PN0501	pck.: 20 rolls with 50 tears	1	0,024	2,5	17x60
0000PN0502	pck.: 20 rolls with 50 tears	1	0,024	2,8	20x60

QUIK-STIK - Viscose and polyester disposable cloth with glue



REF.	NOTES	PCK	VOLUME (m ²)	GROSS WEIGHT (kg)	SIZE (cm) ↓ ↓ ↓
00PU0101000	Pkg: 8 rolls with 50 tears	1	0,037	3,13	20x60



DUST MOPPING

DAMP MOPPING

DUSTPANS

BROOMS AND BRUSHES

EQUIPMENT FOR WAX APPLICATION

PAD HOLDERS

SCRAPERS

FLOOR SQUEEGEES

Dry-Up, the high absorbent disposable cloth made by Filmop, lets you solve any loss of liquid instantly: thanks to its performances, surfaces dry very quickly with the highest hygiene, allowing to continue with the ongoing activities.



- **High absorbency in a few seconds:** the high absorbing polymers of the cloth soak up till 1000 ml from 30 to 150 seconds. Absorbing time and capacity depend on the type of liquid: Dry-Up can indeed absorb water, drinks, chlorine bleach, oil, urine and blood.
- **Maximum safety and hygiene:** the absorbed liquid is bonded safe in the cloth and transformed into gel, allowing a safe and hygienic disposal of the cloth, neither dripping nor trickle, and avoiding cross contamination.
- **High versatility:** perfect to be used in healthcare facilities, elderly homes, restaurants, bars, supermarkets, communities, schools, airports, public toilets, industries, mechanical workshops.



Put Dry-Up onto the leakage of liquid and wait until it absorbs it completely. If necessary, move it slightly without lifting it to absorb the rest of the liquid. Do not step on it, because it could be slippery.



Remove Dry-Up. The liquid, now transformed into gel, is bonded safe in the cloth, avoiding dripping and trickling. Dry-Up leaves the surface completely dry, allowing a fast restart of ongoing activities.



Dispose of the cloth as general waste (please, comply with the specific protocol for hospital waste). Then proceed with the cleaning of the area.

DRY-UP - super-absorbing disposable cloth



REF.	NOTES	PCK	VOLUME (m ²)	GROSS WEIGHT (kg)	SIZE (cm)
0000PN02060		10	0,005	0,37	45x33
0000PN02069	pck.: 5 polybags with 10 pcs	1	0,025	2,07	45x33



DUST MOPPING

DAMP MOPPING

DUSTPANS

BROOMS AND BRUSHES

EQUIPMENT FOR WAX APPLICATION

PAD HOLDERS

SCRAPERS

FLOOR SQUEEGEES

Jobby with telescopic handle

Jobby dustbin is also available with an aluminium **telescopic handle** to facilitate collection operations and protect health. The possibility of adjusting the length of the handle on the basis of the height of the operator prevents the onset of occupational diseases due to the repeated assumption of incorrect postures.



Pocker dustpan with wheels

The Pocker dustpan has a practical **handle** and 80 mm **wheels** for better ergonomics and practicality of use and transport. Pocker is also available in the **4-wheel version** for easier manoeuvrability and handling, particularly during the collection of waste.

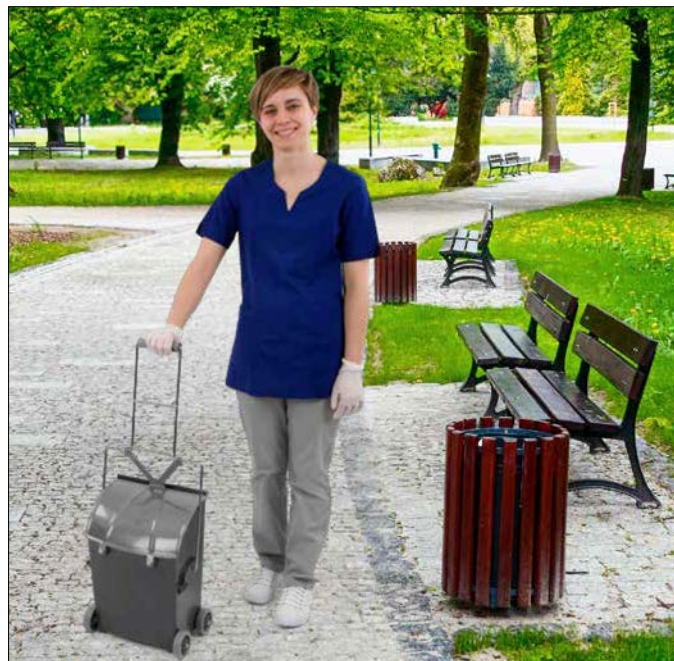

Dustpans with floor squeegee

KIT BAGGY - dustpan with rubber profile, foldable grip, floor squeegee with rubber blade and no. 10 bags 50x60 cm



REF.	NOTES	PCK	VOLUME (m³)	GROSS WEIGHT (kg)
0000PA20400		6	0,067	6,1



BAGGY - dustpan with rubber profile, foldable grip, aluminium handle and bag fixing device, h 82 cm



REF.	NOTES	PCK	VOLUME (m³)	GROSS WEIGHT (kg)
0000PA10400		6	0,067	3,43





DUST MOPPING

DAMP MOPPING

DUSTPANS

BROOMS AND BRUSHES

EQUIPMENT FOR WAX APPLICATION

PAD HOLDERS

SCRAPERS

FLOOR SQUEEGEES

KIT BAGGY - dustpan with rubber profile, floor squeegee with rubber blade and no.10 bags 50x60 cm



REF.	NOTES	PCK	VOLUME (m³)	GROSS WEIGHT (kg)
0000PA20300		6	0,067	6,1

BAGGY - dustpan with rubber profile, aluminium handle, bag fixing device, plastic grip with handle support - h 82 cm



REF.	NOTES	PCK	VOLUME (m³)	GROSS WEIGHT (kg)
0000PA10300		6	0,067	3,43

Floor squeegee for Baggy dustpan 32 cm with aluminium handle - h 97 cm



REF.	NOTES	PCK	VOLUME (m³)	GROSS WEIGHT (kg)
0000SC10200		6	0,011	1,88

Floor squeegee for Baggy dustpan 32 cm, no handle



REF.	NOTES	PCK	VOLUME (m³)	GROSS WEIGHT (kg)
0000SC00200		12	0,006	1,24

Set of 10 bags 50x60 cm for Baggy dustpan



REF.	NOTES	PCK	VOLUME (m³)	GROSS WEIGHT (kg)
SAC025		100	0,04	17,2



DUST MOPPING

DAMP MOPPING

DUSTPANS

BROOMS AND BRUSHES

EQUIPMENT FOR WAX APPLICATION

PAD HOLDERS

SCRAPERS

FLOOR SQUEEGEES

Floor squeegee 55 cm with joint, no handle

REF.	NOTES	PCK	VOLUME (m³)	GROSS WEIGHT (kg)
0000SC00211		12	0,03	3,15

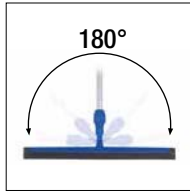

Attaching the cloth TCH120020, the tool can be used for washing floors - The cloth is attached using two clips code 8220/1

Dustpans with brooms

JOBBY - plastic coloured dustpan with aluminium telescopic handle, without cover

REF.	NOTES	PCK	VOLUME (m³)	GROSS WEIGHT (kg)	SIZE (cm)
000010124A		6	0,058	0,74	29x28x67
000010124H		6	0,058	4,64	29x28x67



With serrated edge for an easy removal of the dirt from the broom - Dustbin height: adjustable from 67 to 102 cm

JOBBY - plastic coloured dustpan with aluminium telescopic handle and black cover

REF.	NOTES	PCK	VOLUME (m³)	GROSS WEIGHT (kg)	SIZE (cm)
000010125A		6	0,058	4,61	29x28x67
000010125H		6	0,058	5,35	29x28x67

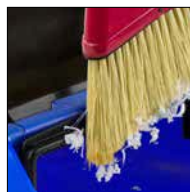

With serrated edge for an easy removal of the dirt from the broom - Dustbin height: adjustable from 67 to 102 cm



DUST MOPPING

DAMP MOPPING

DUSTPANS

BROOMS AND BRUSHES

EQUIPMENT FOR WAX APPLICATION

PAD HOLDERS

SCRAPERS

FLOOR SQUEEGEES

JOBBY - plastic coloured dustpan with aluminium handle and foldable grip, without cover



REF.	NOTES	PCK	VOLUME (m³)	GROSS WEIGHT (kg)	SIZE (cm) ↓ ↓ ↓
000010404A		6	0,073	4,57	29x28x87,5
000010404B		6	0,073	4,57	29x28x87,5
000010404H		6	0,073	4,57	29x28x87,5



With serrated edge for an easy removal of the dirt from the broom

JOBBY - plastic coloured dustpan with aluminium handle, without cover



REF.	NOTES	PCK	VOLUME (m³)	GROSS WEIGHT (kg)	SIZE (cm) ↓ ↓ ↓
000010104A		6	0,073	4,57	29x28x87,5
000010104B		6	0,073	4,57	29x28x87,5
000010104C		6	0,073	4,57	29x28x87,5
000010104F		6	0,073	4,57	29x28x87,5
000010104H		6	0,073	4,57	29x28x87,5



With serrated edge for an easy removal of the dirt from the broom

JOBBY - plastic coloured dustpan with aluminium handle, foldable grip and black cover



REF.	NOTES	PCK	VOLUME (m³)	GROSS WEIGHT (kg)	SIZE (cm) ↓ ↓ ↓
000010405A		6	0,073	5,35	29x28x87,5
000010405B		6	0,073	5,35	29x28x87,5
000010405H		6	0,073	5,35	29x98x87,5



With serrated edge for an easy removal of the dirt from the broom



DUST MOPPING

DAMP MOPPING

DUSTPANS

BROOMS AND BRUSHES

EQUIPMENT FOR WAX APPLICATION

PAD HOLDERS

SCRAPERS

FLOOR SQUEEGEES

JOBBY - plastic coloured dustpan with aluminium handle and black cover



REF.	NOTES	PCK	VOLUME (m³)	GROSS WEIGHT (kg)	SIZE (cm) ↓ ↓ ↓
000010105A		6	0,073	5,35	29x28x87,5
000010105B		6	0,073	5,35	29x28x87,5
000010105C		6	0,073	5,35	29x28x87,5
000010105F		6	0,073	5,35	29x28x87,5
000010105H		6	0,073	5,35	29x28x87,5
000010105U		6	0,073	5,35	29x28x87,5

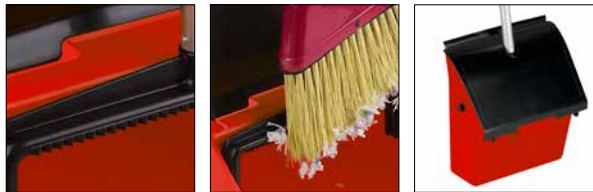

With serrated edge for an easy removal of the dirt from the broom

Broom with handle 80 cm for Jobby dustpan

NEW



REF.	NOTES	PCK	VOLUME (m³)	GROSS WEIGHT (kg)	SIZE (cm) ↓ ↓ ↓
0000SC01030		12	0,022	3,72	25x5x100

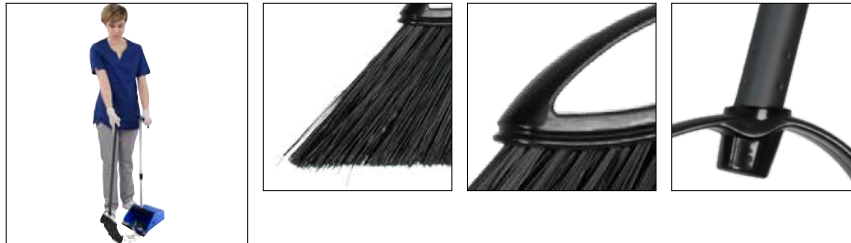

Broom with telescopic handle 65-110 cm for Jobby dustpan



REF.	NOTES	PCK	VOLUME (m³)	GROSS WEIGHT (kg)
0000SC01020		12	0,035	5,8



Metal dustpan with handle



REF.	NOTES	PCK	VOLUME (m³)	GROSS WEIGHT (kg)	SIZE (cm) ↓ ↓ ↓
0000VA01010		12	0,044	10,02	26x35x75



DUST MOPPING

DAMP MOPPING

DUSTPANS

BROOMS AND BRUSHES

EQUIPMENT FOR WAX APPLICATION

PAD HOLDERS

SCRAPERS

FLOOR SQUEEGEES

VERDE - polypropylene broom with wooden handle 110 cm



REF.	NOTES	PCK	VOLUME (m³)	GROSS WEIGHT (kg)
9045		10	0,133	8,88

POCKER - dustpan 15 L with 2 wheels ø 80 mm and ergonomic grip



REF.	NOTES	PCK	VOLUME (m³)	GROSS WEIGHT (kg)	SIZE (cm) ↓ ↓ ↓
000010100YU		4	0,149	8,4	20x32x91



POCKER-4 - dustpan 15 L with 4 wheels ø 80 mm and ergonomic grip



REF.	NOTES	PCK	VOLUME (m³)	GROSS WEIGHT (kg)	SIZE (cm) ↓ ↓ ↓
000020100YU		4	0,214	9,89	20x32x91

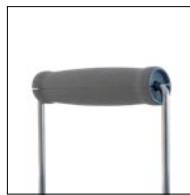

Nipper for safe waste pick-up

REF.	NOTES	PCK	VOLUME (m³)	GROSS WEIGHT (kg)	SIZE (cm) ↓ ↓ ↓
9122		10	0,045	4,24	100
9121		10	0,018	2,44	40



Ideal for the safety collection of syringes, broken glass and similar



DUST MOPPING

DAMP MOPPING

DUSTPANS**BROOMS AND BRUSHES**

EQUIPMENT FOR WAX APPLICATION

PAD HOLDERS

SCRAPERS

FLOOR SQUEEGEES

Plastic dustpan with rubber profile and grip



REF.	NOTES	PCK	VOLUME (m³)	GROSS WEIGHT (kg)	SIZE (cm) ↓ ↓ ↓
0000PA01020U		12	0,063	2,69	20x31x7

Industrial brooms and brushes

STREET - polypropylene broom, no handle

REF.	NOTES	PCK	VOLUME (m³)	GROSS WEIGHT (kg)
9039	Weight: 700 gr	10	0,042	7,01



Fitting handle art. 1070

Industrial broom, stiff nylon with Italian thread

REF.	NOTES	PCK	VOLUME (m³)	GROSS WEIGHT (kg)	SIZE (cm) ↓ ↓ ↓
9020		10	0,049	4,57	33



Fitting handle art. 0000LM30023

Industrial broom, stiff nylon

REF.	NOTES	PCK	VOLUME (m³)	GROSS WEIGHT (kg)	SIZE (cm) ↓ ↓ ↓
9021		10	0,064	11,54	60
9025		6	0,083	13,79	100



Fitting handle art. 1057

Industrial broom, coconut fibers

REF.	NOTES	PCK	VOLUME (m³)	GROSS WEIGHT (kg)	SIZE (cm) ↓ ↓ ↓
9022		6	0,049	7,19	60
9026		6	0,083	11,56	100



Fitting handle art. 1057

[DUST MOPPING](#)
[DAMP MOPPING](#)
[DUSTPANS](#)
BROOMS AND BRUSHES
[EQUIPMENT FOR WAX APPLICATION](#)
[PAD HOLDERS](#)
[SCRAPERS](#)
[FLOOR SQUEEGEES](#)

Industrial broom, soft nylon



REF.	NOTES	PCK	VOLUME (m³)	GROSS WEIGHT (kg)	SIZE (cm) ↓ ↓ ↓
9028		6	0,049	8,13	60
9029		6	0,083	12,74	100

Fitting handle art. 1057

FUGINATOR - Tile grout cleaning brush



REF.	NOTES	PCK	VOLUME (m³)	GROSS WEIGHT (kg)	SIZE (cm) ↓ ↓ ↓
0000GI2004A	with manual handle	12	0,004	0,9	1,7x15,7x8
0000GI2104A	with joint	6	0,004	0,88	4,5x15,7x22



Autoclavable up to 120° C - Fitting telescopic handle ref. 0000AM3060A and Drop tank handle ref. 0000TD0600A

Product suitable for contact with food in accordance with European regulations (EC Regulation 1935/2004 and EU Regulation No. 10/2011) - Compliance Declaration attached to the technical sheet

Household articles

BRILLO - cloth holder for pre-soaked cloths with a set of 25 cloths 25x42 cm



REF.	NOTES	PCK	VOLUME (m³)	GROSS WEIGHT (kg)
5253A	pck. hang-up bag	10	0,043	3,44

Pre-soaked cloths for Brillo



REF.	NOTES	PCK	VOLUME (m³)	GROSS WEIGHT (kg)
5248	pck. hang-up bag with 25 pcs	20	0,019	1,9

GIADA - Plastic broom with Italian thread



REF.	NOTES	PCK	VOLUME (m³)	GROSS WEIGHT (kg)
9041		10	0,032	3,2

It can be used with handle art. 0000LM30023, art. 1059, art. 0000AM30010 and art. 0000AM30020



DUST MOPPING

DAMP MOPPING

DUSTPANS

**BROOMS AND
BRUSHES**
**EQUIPMENT FOR
WAX APPLICATION**

PAD HOLDERS

SCRAPERS

FLOOR SQUEEGEES

PVC broom with bumpers with Italian thread



REF.	NOTES	PCK	VOLUME (m³)	GROSS WEIGHT (kg)	SIZE (cm) ↓ ↓ ↓
9044		12	0,029	4,5	8x34x11

It can be used with handle art. 0000LM30023, art. 1059, art. 0000AM30010 and art. 0000AM30020

Wax applicator tools

SLIDER - wax applicator with tank 1,5 L and sleeve 40 cm



REF.	NOTES	PCK	VOLUME (m³)	GROSS WEIGHT (kg)
8150		1	0,033	2,79



UNILAV SIDE GRIP - tool for wax application with refilling bottle 1 L, Rapido cloth holder and Smart-Fur microfiber mop



REF.	NOTES	PCK	VOLUME (m³)	GROSS WEIGHT (kg)
0002TD1147A		1	0,038	2,08

Mops for wax application

RAPIDO - plastic holder with back fixing hooks



REF.	NOTES	PCK	VOLUME (m³)	GROSS WEIGHT (kg)	SIZE (cm) ↓ ↓ ↓
0000TA0001A		10	0,019	2,73	40x10



DUST MOPPING

DAMP MOPPING

DUSTPANS

BROOMS AND BRUSHES

EQUIPMENT FOR WAX APPLICATION

PAD HOLDERS

SCRAPERS

FLOOR SQUEEGEES

SMART-FUR - bordered microfiber mop with backing for strap tape system and colour-coded tags

REF.	NOTES	PCK	VOLUME (m³)	GROSS WEIGHT (kg)	SIZE (cm) ↓ ↓ ↓
00PN0403H00		25	0,019	2,34	40
00PN0403H00E		25	0,019	2,24	40
00PN0603H00		20	0,015	2,43	60
00PN0603H00E		20	0,015	2,35	60
00PN0803H00		14	0,015	2,48	80
00PN0803H00E		14	0,025	2,62	80
00PN1003H00		10	0,026	2,19	100
00PN1003H00E		10	0,026	2,19	100



Ideal for any kind of surface with medium degree of dirt - The shock-absorbing border guarantees a better protection for and against baseboards and walls

Jointed support with sleeve for wax application



REF.	NOTES	PCK	VOLUME (m³)	GROSS WEIGHT (kg)	SIZE (cm) ↓ ↓ ↓
9400		12	0,024	2,78	35
9100		12	0,03	2,84	40

Jointed support for wax application



REF.	NOTES	PCK	VOLUME (m³)	GROSS WEIGHT (kg)	SIZE (cm) ↓ ↓ ↓
9401		12	0,011	1,82	35
9147		12	0,011	1,75	40

Polyester sleeve for wax application



REF.	NOTES	PCK	VOLUME (m³)	GROSS WEIGHT (kg)	SIZE (cm) ↓ ↓ ↓
9402		25	0,024	1,98	35
9109		25	0,03	2,24	40

Systems for wax application

Bucket trolley for wax application complete with pushing handle, plastic sieve and sleeve 40 cm



REF.	NOTES	CAPACITY (L)	PCK	VOLUME (m³)	GROSS WEIGHT (kg)	SIZE (cm) ↓ ↓ ↓
9200/PRO		20	1	0,093	5,12	30x74x88



DUST MOPPING

DAMP MOPPING

DUSTPANS

BROOMS AND BRUSHES

EQUIPMENT FOR WAX APPLICATION

PAD HOLDERS

SCRAPERS

FLOOR SQUEEGEES

Plastic bucket 20 L with plastic handle



REF.	NOTES	PCK	VOLUME (m³)	GROSS WEIGHT (kg)	SIZE (cm)
0000SE1222A		10	0,169	12,6	24x55x27
0000SE1222B		10	0,169	12,6	24x55x27
0000SE1222U		10	0,169	12,6	24x55x27



Plastic sieve fitting bucket trolley for wax application / window cleaning



REF.	NOTES	PCK	VOLUME (m³)	GROSS WEIGHT (kg)	SIZE (cm)
9206A		30	0,1	7,35	8x53x10

For window washer 35 and 40 cm

TWIN - plastic bucket 2x10 L with two plastic handles



REF.	NOTES	PCK	VOLUME (m³)	GROSS WEIGHT (kg)	SIZE (cm)
7914A		5	0,132	8,79	36x45x26



Fitting window washer 35 cm

Plastic sieve for Twin bucket



REF.	NOTES
21021A	

Fitting window washer 35 cm

Plastic bucket 28 L with plastic handle



REF.	NOTES	SIZE (cm)
0000SE1428A		32x52x27
0000SE1428B		32x52x27





DUST MOPPING

DAMP MOPPING

DUSTPANS

BROOMS AND BRUSHES

EQUIPMENT FOR WAX APPLICATION

PAD HOLDERS

SCRAPERS

FLOOR SQUEEGEES

Pierced plastic sieve for bucket 28 L



REF.	NOTES
P1190043A	

For 40 cm mops and cloths

Plastic cover for bucket 28 L



REF.	NOTES	SIZE (cm) ↓ ↓ ↓
0000CP1128U		33x53x2,8

Wheel ø 50 mm



REF.	NOTES
7949	For King, Spider, Ro-cket Wheels, Duo Pro System, Prisma, Twin, Top-Down®, Pick-Up, Trend and code 0000SE1428

Mop holders and pads

Manual pad holder



REF.	NOTES	PCK	VOLUME (m³)	GROSS WEIGHT (kg)	SIZE (cm) ↓ ↓ ↓
5228A		12	0,014	3,09	10x23

Jointed pad holder



REF.	NOTES	PCK	VOLUME (m³)	GROSS WEIGHT (kg)	SIZE (cm) ↓ ↓ ↓
5229A		12	0,014	2,45	10x23,5

Jointed pad holder with Lock System



REF.	NOTES	PCK	VOLUME (m³)	GROSS WEIGHT (kg)	SIZE (cm) ↓ ↓ ↓
5329A		12	0,019	2,81	10x23,5

Abrasive pad



REF.	NOTES	PCK	VOLUME (m³)	GROSS WEIGHT (kg)	SIZE (cm) ↓ ↓ ↓
5222		12	0,011	0,45	12x25x2
5222F		12	0,011	0,84	12x25x2
5222G		12	0,011	0,84	12x25x2
5222H		12	0,011	0,84	12x25x2



DUST MOPPING

DAMP MOPPING

DUSTPANS

BROOMS AND BRUSHES

EQUIPMENT FOR WAX APPLICATION

PAD HOLDERS

SCRAPERS

FLOOR SQUEEGEES

Scrapers and blades

Floor scraper with plastic grip

NEW



REF.	NOTES	PCK	VOLUME (m³)	GROSS WEIGHT (kg)
9851		25	0,019	0,34

Floor scraper with metal handle

NEW



REF.	NOTES	PCK	VOLUME (m³)	GROSS WEIGHT (kg)
9852	with 25 cm handle	25	0,019	0,34
9853	with 120 cm handle	10	0,033	0,79



Blades for floor scraper



REF.	NOTES
9154	1 pc art. 9154 = 100 blades



Metal floor squeegee

Metal floor squeegee with black rubber



REF.	NOTES	PCK	VOLUME (m³)	GROSS WEIGHT (kg)	SIZE (cm) ↓ ↓ ↓
9007		12	0,028	5,09	45
9008		12	0,035	5,65	55
9009		12	0,046	6,92	75



DUST MOPPING

DAMP MOPPING

DUSTPANS

BROOMS AND BRUSHES

EQUIPMENT FOR WAX APPLICATION

PAD HOLDERS

SCRAPERS

FLOOR SQUEEGES

Plastic floor squeegees

Autoclavable floor squeegee with soft rubber blade for food industry, with Italian screw and coloured support



REF.	NOTES	PCK	VOLUME (m³)	GROSS WEIGHT (kg)	SIZE (cm) ↓ ↓ ↓ ↓
00009312DD		10	0,025	2,74	45
00009313AD		10	0,02	3,9	55
00009313BD		10	0,02	3,9	55
00009313CD		10	0,02	3,9	55
00009313DD		10	0,02	3,9	55
00009313FD		10	0,02	3,9	55
00009314DD		10	0,046	4,13	75



Product suitable for contact with food in accordance with European regulations (EC Regulation 1935/2004 and EU Regulation No. 10/2011) - Compliance Declaration attached to the technical sheet

Plastic floor squeegee, with white rubber blade and coloured support

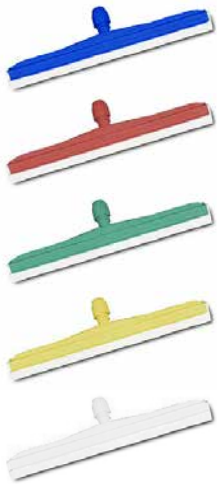

REF.	NOTES	PCK	VOLUME (m³)	GROSS WEIGHT (kg)	SIZE (cm) ↓ ↓ ↓ ↓
00009011AD		12	0,023	2,21	35
00009012AD		12	0,028	2,79	45
00009012BD		12	0,028	2,79	45
00009012CD		12	0,028	2,57	45
00009012DD		12	0,028	2,79	45
00009012FD		12	0,028	2,79	45
00009013AD		12	0,035	3,21	55
00009013BD		12	0,035	3,21	55
00009013CD		12	0,035	3,21	55
00009013DD		12	0,035	3,21	55
00009013FD		12	0,035	3,21	55
00009014AD		12	0,046	4,3	75
00009014BD		12	0,046	4,3	75
00009014CD		12	0,046	4,3	75
00009014DD		12	0,046	4,3	75
00009014FD		12	0,046	4,3	75

Plastic floor squeegee with black rubber



REF.	NOTES	PCK	VOLUME (m³)	GROSS WEIGHT (kg)	SIZE (cm) ↓ ↓ ↓ ↓
00009011AH		12	0,023	2,21	35
00009012AH		12	0,028	2,79	45
00009013AH		12	0,035	3,21	55
00009014AH		12	0,046	4,3	75



Floor cleaning

Mop system

Tab system

Pocket system

Pocket-tab system

Strap tape system

Globo system

Duo Face system

Dosing handles

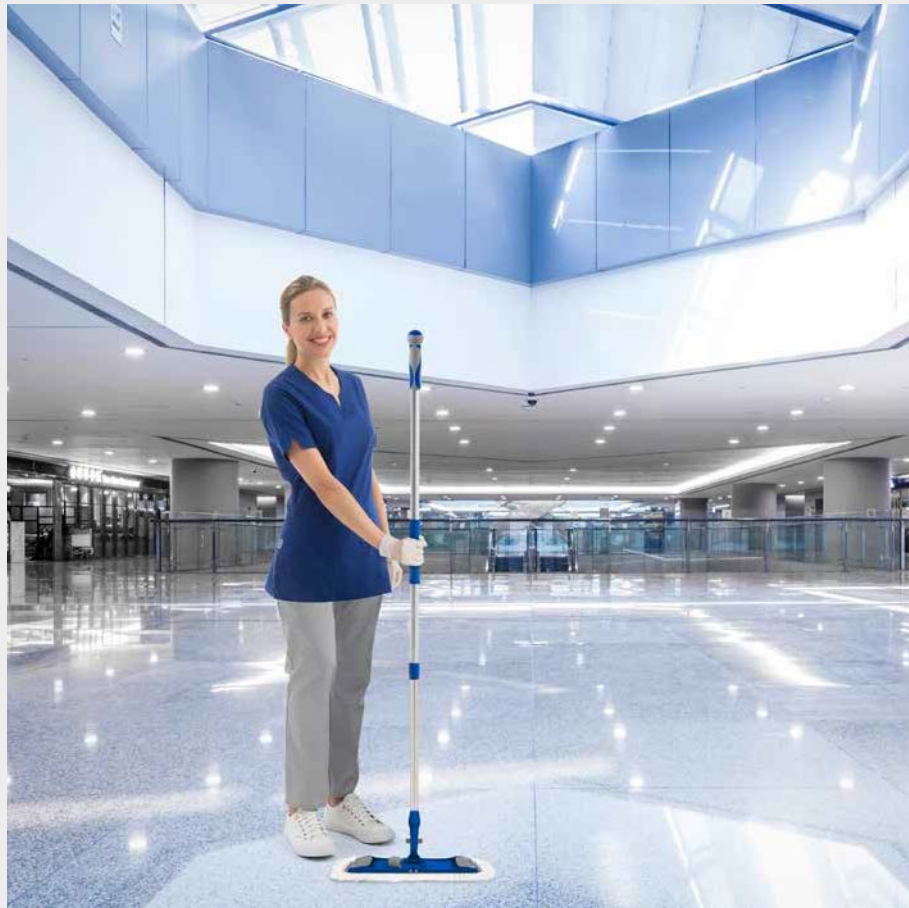



MOP SYSTEM

TAB SYSTEM

POCKET SYSTEM

POCKET-TAB SYSTEM

STRAP TAPE SYSTEM

GLOBO SYSTEM

DUO FACE SYSTEM

DOSING HANDLES

YARNS



Natural highly absorbing fiber. Available in Open-end cotton. Fitting all kinds of inside floors.

50°

COTON



String mop made of microfibre stripes with high absorbing power, it glides easily on the surfaces ensuring an effective cleaning. Fitting all kinds of inside floors.

90°

STRIPE MOP



Microfibre mop with high absorbing power, it penetrates into the micropores of the floor, cleaning and thoroughly degreasing it. Fitting all kinds of inside floors.

30°

DREAM MOP



Mop made of synthetic fiber, it cleans effectively and assures a high washing autonomy. Great resistance to aggressive chemicals such as chlorine and hypochlorite. Advised for food and chemical industry.

30°

SYNTHETIC MOP



Please, refer to pages 18-19 for washing instructions.

YARN MANUFACTURING PROCESS



LOOPED YARN

It grants a longer life of the mop: this yarn processing prevents from mop fraying and linting.



TWISTED YARN

It guarantees a more compact yarn making easier the cleaning operations.



BAND

It guarantees a uniform distribution of the mop strings on the floor and avoids getting trapped into possible obstacles in the cleaning area.

KIND OF SUPPORT



5 cm support.



8 cm support.

EU ECOLABEL CERTIFIED PRODUCTS

Filmop International has obtained for the line of mops **mop Open-End** and **Master Lux** the prestigious **Ecolabel UE** certification, the European Union eco-label that rewards **best eco-friendly products**.

The certification attests the **low environmental impact** of the products after having analyzed their sustainability throughout their entire life cycle through a series of very selective parameters, established by the European Community.



OPEN-END COTTON MOP

MASTER LUX THICK YARN



MOP SYSTEM

TAB SYSTEM

POCKET SYSTEM

POCKET-TAB SYSTEM

STRAP TAPE SYSTEM

GLOBO SYSTEM

DUO FACE SYSTEM

DOSING HANDLES

Mops

Open-end cotton mop with 8 cm support



REF.	NOTES	WEIGHT (gr)	PCK	VOLUME (m ²)	GROSS WEIGHT (kg)
000E6013		350	50	0,09	18,56
000E6014		400	50	0,09	21,06
000E6109		460	50	0,09	24,06
000E6110		500	50	0,106	26,11



Open-end cotton mop with band and 8 cm support



REF.	NOTES	WEIGHT (gr)	PCK	VOLUME (m ²)	GROSS WEIGHT (kg)
000E6015		350	50	0,09	18,56
000E6016		400	50	0,09	21,06
000E6112		460	50	0,09	24,06
000E6113		500	50	0,106	26,11



Open-end cotton mop with 5 cm support



REF.	NOTES	WEIGHT (gr)	PCK	VOLUME (m ²)	GROSS WEIGHT (kg)
6000		350	50	0,09	18,56
6001		400	50	0,09	21,06



Open-end cotton mop, looped yarn



REF.	NOTES	WEIGHT (gr)	PCK	VOLUME (m ²)	GROSS WEIGHT (kg)
6030		400	50	0,09	21,06





MOP SYSTEM

TAB SYSTEM

POCKET SYSTEM

POCKET-TAB SYSTEM

STRAPTAPE SYSTEM

GLOBO SYSTEM

DUO FACE SYSTEM

DOSING HANDLES

Open-end cotton mop, looped yarn, with band



REF.	NOTES	WEIGHT (gr)	PCK	VOLUME (m³)	GROSS WEIGHT (kg)
6035		400	50	0,09	21,06
6036		460	50	0,106	24,11



Open-end cotton mop with coloured yarn



REF.	NOTES	WEIGHT (gr)	PCK	VOLUME (m³)	GROSS WEIGHT (kg)
6050A		400	50	0,09	21,06
6050F		400	50	0,09	21,06



White synthetic mop with coloured support



REF.	NOTES	PCK	VOLUME (m³)	GROSS WEIGHT (kg)
6201D	with white support	50	0,113	13,74
6201DA	with blue support	50	0,148	13,83
6201DB	with red support	50	0,148	13,83
6201DC	with yellow support	50	0,148	13,83
6201DF	with green support	50	0,148	13,83



White synthetic mop with coloured band and coloured support



REF.	NOTES	PCK	VOLUME (m³)	GROSS WEIGHT (kg)
6211D	with white band and white support	50	0,148	13,83
6211DA	with blue band and blue support	50	0,148	13,83
6211DB	with red band and red support	50	0,148	13,83
6211DC	with yellow band and yellow support	50	0,148	13,83
6211DF	with green band and green support	50	0,148	13,83





- MOP SYSTEM
- TAB SYSTEM
- POCKET SYSTEM
- POCKET-TAB SYSTEM
- STRAP TAPE SYSTEM
- GLOBO SYSTEM
- DUO FACE SYSTEM
- DOSING HANDLES

Synthetic mop, twisted yarn

REF.	NOTES		PCK	VOLUME (m ²)	GROSS WEIGHT (kg)
6202D	with white support		50	0,124	13,72
6202DA	with blue support		50	0,124	13,72
6202DB	with red support		50	0,124	13,72
6202DC	with yellow support		50	0,124	13,72
6202DF	with green support		50	0,124	13,72



DREAM MOP - white-blue microfiber mop, looped yarn

REF.	NOTES	WEIGHT (gr)	PCK	VOLUME (m ²)	GROSS WEIGHT (kg)
6205D		350	25	0,055	9,45
6204D		400	25	0,09	11,06

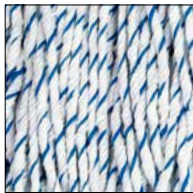
STRIPE MOP -String mop made of blue microfibre stripes, looped yarn

REF.	NOTES	WEIGHT (gr)	PCK	VOLUME (m ²)	GROSS WEIGHT (kg)
6206A		240	25	0,065	6,85



STRIPE MOP -String mop made of colored microfibre stripes

REF.	NOTES	WEIGHT (gr)	PCK	VOLUME (m ²)	GROSS WEIGHT (kg)
6207A		250	25	0,05	7,12
6207B		250	25	0,05	7,12
6207C		250	25	0,05	7,12
6207F		250	25	0,05	7,12
6208A		350	25	0,09	9,81





MOP SYSTEM

TAB SYSTEM

POCKET SYSTEM

POCKET-TAB SYSTEM

STRAP TAPE SYSTEM

GLOBO SYSTEM

DUO FACE SYSTEM

DOSING HANDLES

Mop holders

Big plastic mop holder



REF.	NOTES	PCK	VOLUME (m³)	GROSS WEIGHT (kg)
6020U-10		50	0,035	4,89
6020A-10		50	0,035	4,89
6020B-10		50	0,035	4,89
6020C-10		50	0,035	4,89
6020F-10		50	0,035	4,89

Plastic mop holder with fixing clip for mop, big size



REF.	NOTES	PCK	VOLUME (m³)	GROSS WEIGHT (kg)
6020U/1-10		50	0,035	4,99
6020A/1-10		50	0,035	4,99
6020B/1-10		50	0,035	5,49
6020C/1-10		50	0,035	4,99
6020F/1-10		50	0,035	4,99

Normal size plastic mop holder for mop with Italian thread



REF.	NOTES	PCK	VOLUME (m³)	GROSS WEIGHT (kg)
6021	only for handles with thread	50	0,028	3,57

Available while stocks last

Bags for mop washing

White polyester mesh bag with rubber string



REF.	NOTES	CAPACITY (L)	SIZE (cm) ↓ ↓ ↓
6073		70	90x77
6074		90	95x95

Mesh bag with closing string



REF.	NOTES	CAPACITY (L)	SIZE (cm) ↓ ↓ ↓
0000AT0210A	polypropylene	30	30x60
0000AT0210B	polypropylene	30	30x60
0000AT0210C	polypropylene	30	30x60
0000AT0210F	polypropylene	30	30x60
0000AT0211A	polyester	50	30x90
0000AT0211B	polyester	50	30x90
0000AT0212A	stabilized polyester	70	60x90
0000AT0212B	stabilized polyester	70	60x90
0000AT0214B	stabilized polyester	35	65x46

Ideal for supports art. P1909914U, P1909926U and P1909927U



MOP SYSTEM

TAB SYSTEM

POCKET SYSTEM

POCKET-TAB SYSTEM

STRAP TAPE SYSTEM

GLOBO SYSTEM

DUO FACE SYSTEM

DOSING HANDLES

Master Lux universal screw

MASTER LUX - cotton mop with thick yarn, plastic support with universal thread



REF.	NOTES	WEIGHT (gr)	PCK	VOLUME (m³)	GROSS WEIGHT (kg)
000E2036	with grey plastic support	220	50	0,055	11,73
000E2036B	with red plastic support	220	50	0,055	11,73
000E2037	with grey plastic support	280	50	0,073	14,84
000E2037B	with red plastic support	280	50	0,073	14,84
000E2037C	with yellow plastic support	280	50	0,073	14,84
000E2037F	with green plastic support	280	50	0,073	14,84
000E2045	with grey plastic support	400	50	0,091	20,98



MASTER LUX - cotton mop with thick yarn, looped yarn, plastic support with universal thread



REF.	NOTES	WEIGHT (gr)	PCK	VOLUME (m³)	GROSS WEIGHT (kg)
3036	with blue plastic support	220	50	0,073	11,84
3037	with blue plastic support	280	50	0,07	15,4



MASTER LUX - cotton mop with thin yarn, plastic support with universal thread



REF.	NOTES	WEIGHT (gr)	PCK	VOLUME (m³)	GROSS WEIGHT (kg)
2039	with blue plastic support	220	50	0,073	11,84
2040	with blue plastic support	280	50	0,073	14,84
2040B	with red plastic support	280	50	0,073	14,84
2040C	with yellow plastic support	280	50	0,073	14,84
2040F	with green plastic support	280	50	0,073	14,84
2046	with blue plastic support	330	50	0,091	17,48

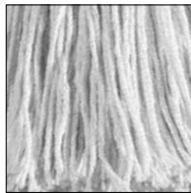



MOP SYSTEM

TAB SYSTEM

POCKET SYSTEM

POCKET-TAB SYSTEM

STRAP TAPE SYSTEM

GLOBO SYSTEM

DUO FACE SYSTEM

DOSING HANDLES

MASTER LUX - synthetic mop, plastic support with universal thread



REF.	NOTES		PCK	VOLUME (m³)	GROSS WEIGHT (kg)
6300D	white, with blue plastic support		50	0,091	8,98
6300B	white, with red plastic fitting		50	0,091	8,98
6300C	white, with yellow plastic fitting		50	0,091	8,98
6300F	white, with green plastic fitting		50	0,091	8,98



MASTER LUX - synthetic white mop, twisted yarn, plastic support with universal thread



REF.	NOTES		PCK	VOLUME (m³)	GROSS WEIGHT (kg)
6400D	with blue plastic support		50	0,091	10,48
6400B	with red plastic support		50	0,091	10,48
6400C	with yellow plastic support		50	0,091	10,48
6400F	with green plastic support		50	0,091	10,48



DREAM MOP - white-blue microfiber mop, looped yarn, plastic support with universal thread



REF.	NOTES		PCK	VOLUME (m³)	GROSS WEIGHT (kg)
6310D	with blue plastic support		25	0,034	6,07
6310B	with red plastic support		25	0,034	6,07
6310C	with yellow plastic support		25	0,034	6,07
6310F	with green plastic support		25	0,034	6,07



STRIPE MOP - mop made of microfiber stripes, plastic support with universal thread



REF.	NOTES		WEIGHT (gr)	PCK	VOLUME (m³)	GROSS WEIGHT (kg)
6320A			200	25	0,048	5,57
6320B			200	25	0,048	5,57
6320C			200	25	0,048	5,57
6320F			200	25	0,048	5,57





MOP SYSTEM

TAB SYSTEM

POCKET SYSTEM

POCKET-TAB SYSTEM

STRAP TAPE SYSTEM

GLOBO SYSTEM

DUO FACE SYSTEM

DOSING HANDLES

Moppy

MOPPY - cotton mop with thin yarn



REF.	NOTES	WEIGHT (gr)	PCK	VOLUME (m³)	GROSS WEIGHT (kg)
0000M02230		220	50	0,082	12,01
0000M02530		250	50	0,082	13,51



Plastic mop holder with ring for Moppy



REF.	NOTES	PCK	VOLUME (m³)	GROSS WEIGHT (kg)
6025A		50	0,035	5,49

Plastic mop holder with Italian thread for Moppy



REF.	NOTES	PCK	VOLUME (m³)	GROSS WEIGHT (kg)
6027F	only for handles with thread	50	0,035	5,49

Available while stocks last

Bonnet mops

Microfiber bonnet mop



REF.	NOTES	PCK	VOLUME (m³)	GROSS WEIGHT (kg)
0000D225000	ø 25 cm - 10"	10	0,014	0,87
6048	ø 33 cm - 13"	15	0,035	4,39
0000D235000	ø 35 cm - 14"	15	0,035	2,17
6047	ø 43 cm - 17"	40	0,123	21,61
0000D250000	ø 50 cm - 20"	25	0,123	6,81
0000D253000	ø 53 cm - 21"	25	0,123	6,86





MOP SYSTEM

TAB SYSTEM

POCKET SYSTEM

POCKET-TAB
SYSTEM

STRAPTAPE
SYSTEM

GLOBO SYSTEM

DUO FACE SYSTEM

DOSING HANDLES

Cotton bonnet mop

REF.	NOTES	PCK	VOLUME (m³)	GROSS WEIGHT (kg)
6041	ø 43 cm	15	0,049	5,04



Available while stocks last

Cotton bonnet mop, double sided

REF.	NOTES	PCK	VOLUME (m³)	GROSS WEIGHT (kg)
6042	ø 33 cm	10	0,025	2,6
6043	ø 43 cm	30	0,123	16,51



Available while stocks last



Microfiber: the cleaning ally

Microfiber is a **fiber with a fineness of 1 decitex or less**, equivalent to **1 gram per 10 km of yarn**. It is obtained from synthetic yarns such as polyester, polyamide, viscose or polypropylene, whose fibers are divided into **countless filaments a hundred times thinner than a hair**. The very thin thickness allows the filaments to **reach into every porosity of the surface, removing even the smallest particle of dirt** with ease.

In addition, the incredible capillarity that characterizes the microfiber determines a significantly **higher absorbency than traditional yarns**, ensuring a wide floor covering.

The synthetic fibres used to make microfiber products develop a static charge by friction which **attracts and traps dust**.

A high percentage of **polyester** in the microfiber textiles increases its effectiveness: it **removes greasy dirt completely**, leaving the surface perfectly clean.



Ultra-microfiber: the evolution of the yarn

Ultra-microfiber offers the same advantages as microfiber but differs in the **extremely thin size of the yarn** which is greatly reduced in thickness.

The incredibly small size exponentially **multiplies the points of contact** of the textile with the surface, ensuring truly **unrivaled cleanliness**.

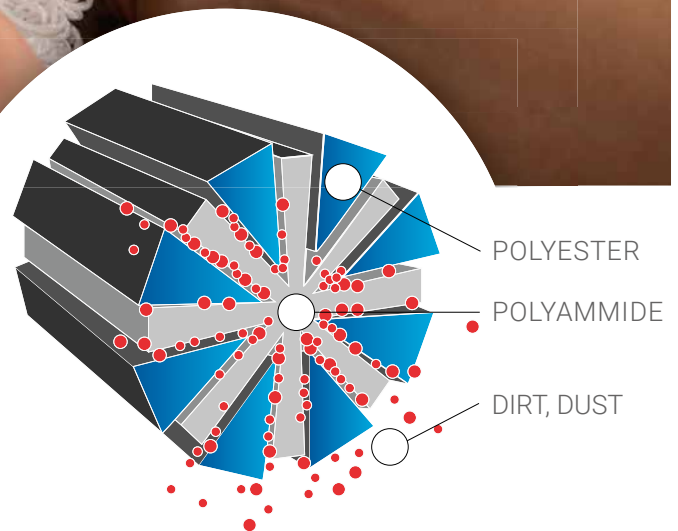

DEEP
CLEANING



EFFECTIVE
DUSTING



LONG
LASTING



COST
REDUCTION



LOW
ENVIRONMENTAL
IMPACT



Fighting Covid with Filmop microfibers

Cleaning is a **key point in preventing the spread of Coronavirus**, so the equipment used must be up to the delicate task it is called upon to perform. For this reason, Filmop decided to arrange for an external microbiology laboratory to test the viral removal capacity of different types of mops.

Rapido, Rapido Super Extra, A-B Plus, Micro-Activa, Wash Basic and **Active-Fur** floor microfibers, **Mono-Tex** disposable microfiber, and **Eco Multi-T** surface microfiber **passed with flying colors the rigorous test** carried out by the independent laboratory: in fact, the analysis found efficacy in viral removal by all tested textile products moistened with only sterile water before their use. In particular, the test showed **99 percent removal of Human Coronavirus 229E** from steel surfaces, establishing the undisputed ability of Filmop microfibers to effectively counteract the spread of Covid-19.





Release of microplastics: Filmop products pass the test

The presence of microplastic particles in aquatic ecosystems has attracted widespread attention in recent years and has become the subject of an increasing number of studies motivated by environmental and health concerns.

The causes of the tiny pieces of plastic material reaching the oceans are many, each with a different impact on the total sum. **The amount of microplastics released varies from textile to textile**, so quantifying them allows an objective evaluation of the impact.

Eco Multi-T manual cloth and **Micro-Activa, Twist-Tuft, Rapido Super Extra, Rapido Super, Rapido, Duo Face Wash Basic, Puli-Brush** and **Puli-Scrub** mops were tested by a highly specialised independent laboratory for the release of microplastics.

All products passed the test with flying colours:

the Eco Multi-T cloth, Micro-Activa, Twist-Tuft, Duo Face Wash Basic, Puli-Brush and Puli-Scrub mop heads were tested for particularly low wash and rinse losses and received the highest rating.

In addition, the Rapido Super Extra, Rapido Super and Rapido mop heads showed low release.

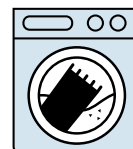

LOW ENVIRONMENTAL IMPACT PRODUCTS



MOP SYSTEM

TAB SYSTEM

POCKET SYSTEM

POCKET-TAB SYSTEM

STRAP TAPE SYSTEM

GLOBO SYSTEM

DUO FACE SYSTEM

DOSING HANDLES

Filmop yarns



Natural highly absorbing fiber that keeps dirt, releasing it only during the washing of the mop. Ideal for all inside floors with a medium degree of dirt.

COTON

70% Cotton - 30% Polyester



The combination of cotton, a natural fiber with a high absorbing level, and polyester, a synthetic fiber very strong and resistant to washings, guarantees a perfect running of the mop on the floor. Ideal for all inside floors with a medium degree of dirt.

POLYESTER-COTTON

70% Polyester - 30% Cotton



Microfiber is a synthetic fiber which penetrates deep into the grooves and pores of floors, absorbing the removed dirt and retaining it till mop washing. Ideal for dusting and washing industrial floors, natural stone, single-fired tiles and stoneware with medium to high dirt degree.

RAPIDO

80% Microfiber (100% Polyester) + 20% Polyamide



Microfiber provides deeper cleaning, greater efficiency and gliding thanks to its fibers that penetrate more easily into the microporosity of the floor. Ideal for washing any type of interior floor with medium to high dirt degree.

RAPIDO SUPER

100% Microfiber (80% Polyester - 20% Polyamide)



High-performance **microfiber** designed to assure deep cleaning and high glide even on porous surfaces. Ideal for washing industrial floors, natural stone, single-fired tiles and stoneware with medium to high dirt degree.

RAPIDO SUPER EXTRA

100% Microfiber (80% Polyester - 20% Polyamide)



Microfiber with high cleaning power and high absorbency that guarantees an excellent cleaning result, even with intense dirt. Ideal for washing any type of floor, both continuous and tiled with joints, with a medium-high degree of dirt.

TWIST-TUFT

100% Microfiber (80% Polyester - 20% Polyamide)



Microfiber better releases the micro-particles of dirt, cotton improves the absorbing capacity of the mop, covering more washable square meter, while polyester allows an easier running of the mop on the floors. Ideal for all inside floors with a medium-high degree of dirt.

TRIPLO

70% Polyester - 30% Cotton



The **ultra-microfiber AB-Plus**, thanks to the special antibacterial treatment with silver ions, is ideal to avoid the proliferation of bacteria and cross-contamination. It eliminates up to 99.98% of bacteria and inhibits their growth thanks to the electrostatic action. Ideal for washing hospital interior floors with a medium degree of dirt.

ANTIBACTERIAL ULTRA-MICROFIBER

75% Ultra-Microfiber (80% Polyester - 20% Polyamide) + 25% Polyester



MOP SYSTEM

TAB SYSTEM

POCKET SYSTEM

POCKET-TAB SYSTEM

STRAP TAPE SYSTEM

GLOBO SYSTEM

DUO FACE SYSTEM

DOSING HANDLES

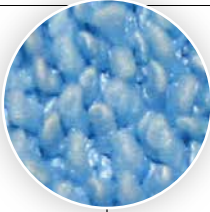

Ultra-microfiber characterized by high absorbency and excellent glide, requires little mechanical friction on the floor and cleans effectively and deeply. Ideal for frequent washing of industrial, single-fired, stoneware and wood floors with a medium degree of dirt.



MICRO-ACTIVA

75% Ultra-Microfiber (80% Polyester - 20% Polyamide) + 25% Polyester

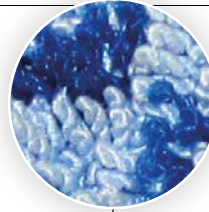

Ultra-microfiber with polypropylene inserts that allow the removal of the most difficult dirt while offering excellent glide. Ideal for scrubbing and washing non-slip floors and natural terracotta with a medium degree of dirt, characterized by stubborn dirt.



PULI-SCRUB

70% Ultra-Microfiber (71% Polyester - 29% Polyamide) + 30% Polypropylene



Ultra-microfiber with polypropylene inserts that allow the removal of the most difficult dirt while offering excellent glide. It is characterized by its high absorbent power. Ideal for scrubbing and washing non-slip floors and natural terracotta with medium to high level of dirt, characterized by stubborn dirt.



PULI-SCRUB PLUS

70% Ultra-Microfiber (71% Polyester - 29% Polyamide) + 30% Polypropylene

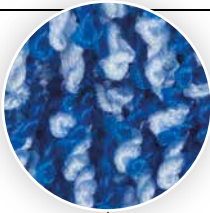

It provides excellent glide and fast, effective cleaning due to its special **ultra-microfiber** and polypropylene composition. Ideal for scrubbing and washing non-slip floors and natural terracotta with a high level of dirt, characterized by stubborn dirt.



PULI-BRUSH

50% Ultra-Mikrofaser (80% Polyester - 20% Polyamid) + 50% Polypropylen

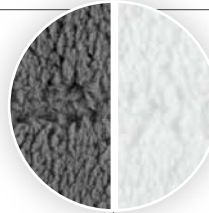

Thanks to the small size of the yarn and the high electrostatic power, the **microfiber** has a mechanical action on the molecules of dirt removing them and trapping them between the fibers. Ideal for spray cleaning and dusting on any kind of floor with medium degree of dirt.

SMART-FUR

100% Polyester Microfiber

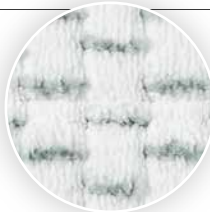

Microfiber with nylon inserts for a lower mop friction and a better dirt collection. Ideal for light scrubbing and washing of industrial, single-fired, stoneware and wood floors with a medium degree of dirt.

ACTIVE-FUR

85% Microfibras (100% Poliestere) + 15% Poliammide

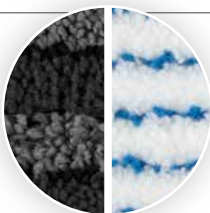

Microfibre with stripes, whose composition offers a perfect balance between cleaning power and mop friction. Ideal for washing industrial, single-fired and stoneware floors with low dirt degree.

SKILL-FUR

60% Microfiber (100% Polyester) + 40% Polyester



For perfect textile care, a washing temperature of 60°C, maximum 95°C, is recommended.

Please, refer to pages 18-19 for washing instructions.



MOP SYSTEM

TAB SYSTEM

POCKET SYSTEM

POCKET-TAB SYSTEM

STRAP TAPE SYSTEM

GLOBO SYSTEM

DUO FACE SYSTEM

DOSING HANDLES

Filmop is the first Italian company designing and producing an innovative floor flat mopping system, overcoming the traditional ones employing string mops.

Filmop has conceived a new mopping system based on a flat plastic mop holder, named **Telaio Speedy®**, to increase the size of the cleaning tool mopping the floor with important advantages in terms of time and collection of dirt.

Moreover, Speedy mop holders are foldable allowing to wring the mop without dropping it from the mop holder.

All Filmop mop holders can be equipped with **Lock System** that improves the cleaning of walls and ceilings just locking and unlocking the joint simply pushing up and down the special device using one's foot.



Folded mop holder to wring the mop

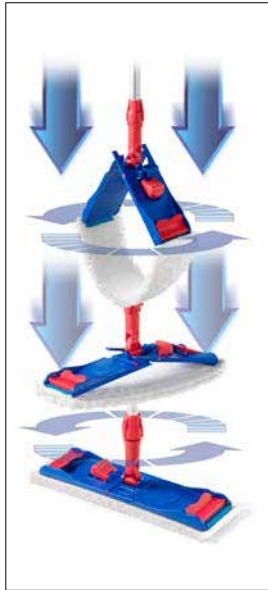

Spin the mop holder and let it drop onto the floor to open it



Unlocked joint:
floor cleaning



Locked joint:
cleaning of walls and ceilings

Speedy mop holders

SPEEDY MOP HOLDER® - foldable plastic mop holder



REF.	NOTES	PCK	VOLUME (m³)	GROSS WEIGHT (kg)	SIZE (cm) ↓ ↓ ↓
00008116AB		10	0,024	5,8	40x11
8125AB		10	0,035	10,06	50x13

SPEEDY MOP HOLDER® - foldable plastic mop holder with Lock System fitting



REF.	NOTES	PCK	VOLUME (m³)	GROSS WEIGHT (kg)	SIZE (cm) ↓ ↓ ↓
00008316AB		10	0,024	6,1	40x11

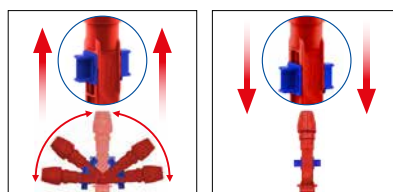



MOP SYSTEM

TAB SYSTEM

POCKET SYSTEM

POCKET-TAB SYSTEM

STRAP TAPE SYSTEM

GLOBO SYSTEM

DUO FACE SYSTEM

DOSING HANDLES

SPEEDY MOP HOLDER® - plastic foldable mop holder with ErgoSwing fitting



REF.	NOTES	PCK	VOLUME (m³)	GROSS WEIGHT (kg)	SIZE (cm) ↓ ↓ ↓
00008916AB		10	0,028	6,45	40x11

Use with ErgoSwing system handle, code 0000AM3045 - Learn more about ErgoSwing in the handle section

Speedy mops

Mop **SPEEDY** polyester and cotton, polyester backing, looped yarn, with flaps 2 holes

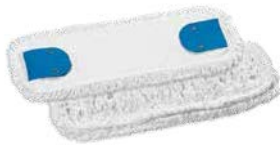

REF.	NOTES	PCK	VOLUME (m³)	GROSS WEIGHT (kg)	SIZE (cm) ↓ ↓ ↓
8414	for 40 x 11 cm mop holders	25	0,028	4,18	40x13
8420	for mop holders 50 x 13 cm	25	0,033	5,61	50x16

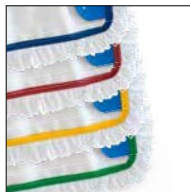

Ideal for any surface with medium dirt - Mops with colored borders available on request - Contact our offices for minimum quantity

Mop **SPEEDY** polyester and cotton, polyester backing, looped yarn inside and cut yarn outside, with flaps 2 holes



REF.	NOTES	PCK	VOLUME (m³)	GROSS WEIGHT (kg)	SIZE (cm) ↓ ↓ ↓
8414/M	for 40 x 11 cm mop holders	25	0,028	4,18	40x13
8420/M	for mop holders 50 x 13 cm	25	0,033	6,09	50x16

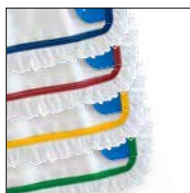

Ideal for any surface with medium dirt - Mops with colored borders available on request - Contact our offices for minimum quantity

Mop **SPEEDY** cotton, polyester backing, looped yarn, with flaps 2 holes



REF.	NOTES	PCK	VOLUME (m³)	GROSS WEIGHT (kg)	SIZE (cm) ↓ ↓ ↓
0C08414	for 40 x 11 cm mop holders	25	0,028	3,93	40x13
0C08420	for mop holders 50 x 13 cm	25	0,033	5,86	50x16

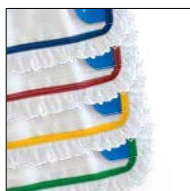

Ideal for any surface with medium dirt - Mops with colored borders available on request - Contact our offices for minimum quantity



MOP SYSTEM

TAB SYSTEM

POCKET SYSTEM

POCKET-TAB SYSTEM

STRAP TAPE SYSTEM

GLOBO SYSTEM

DUO FACE SYSTEM

DOSING HANDLES

Mop **SPEEDY** cotton, polyester backing, looped yarn inside and cut yarn outside, with flaps 2 holes

REF.	NOTES	PCK	VOLUME (m³)	GROSS WEIGHT (kg)	SIZE (cm) ↓ ↓ ↓
0C08414/M	for 40 x 11 cm mop holders	25	0,028	3,93	40x13
0C08420/M	for mop holders 50 x 13 cm	25	0,033	5,86	50x16

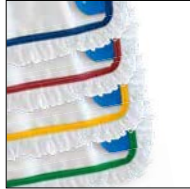

Ideal for any surface with medium dirt - Mops with colored borders available on request - Contact our offices for minimum quantity

Mop **SPEEDY** polyester and cotton, polyester backing, looped yarn inside and cut yarn outside, with external flaps 2 holes

REF.	NOTES	PCK	VOLUME (m³)	GROSS WEIGHT (kg)	SIZE (cm) ↓ ↓ ↓
8511/M	for 40 x 11 cm mop holders	25	0,024	4,17	40x13
8518/M	for mop holders 50 x 13 cm	25	0,03	5,69	50x16



Ideal for any surface with medium dirt

Mop **SPEEDY** polyester and cotton, polyester backing, looped yarn, with external flaps 2 holes

REF.	NOTES	PCK	VOLUME (m³)	GROSS WEIGHT (kg)	SIZE (cm) ↓ ↓ ↓
8511	for 40 x 11 cm mop holders	25	0,024	4,17	40x13



Ideal for any surface with medium dirt

Mop **SPEEDY** cotton, polyester backing, looped yarn inside and cut yarn outside, with external flaps 2 holes

REF.	NOTES	PCK	VOLUME (m³)	GROSS WEIGHT (kg)	SIZE (cm) ↓ ↓ ↓
0C08511/M	for 40 x 11 cm mop holders	25	0,024	3,67	40x13



Ideal for any surface with medium dirt



MOP SYSTEM

TAB SYSTEM

POCKET SYSTEM

POCKET-TAB SYSTEM

STRAP TAPE SYSTEM

GLOBO SYSTEM

DUO FACE SYSTEM

DOSING HANDLES

Mop **SPEEDY** cotton, polyester backing, looped yarn, with external flaps 2 holes

REF.	NOTES	PCK	VOLUME (m³)	GROSS WEIGHT (kg)	SIZE (cm) ↓ ↓ ↓
0C08511	for 40 x 11 cm mop holders	25	0,024	4,17	40x13

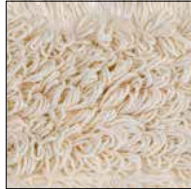

Ideal for any surface with medium dirt

Mop **SPEEDY RAPIDO** microfiber, polyester backing, looped yarn, with flaps 2 holes

REF.	NOTES	PCK	VOLUME (m³)	GROSS WEIGHT (kg)	SIZE (cm) ↓ ↓ ↓
0000121D	for 40 x 11 cm mop holders	25	0,028	4,43	40x13
0000611D	for mop holders 50 x 13 cm	25	0,033	5,36	50x16



Ideal for industrial floors, natural stones, single-fired tiles and stoneware with a medium-high degree of dirt

Mop **SPEEDY RAPIDO** coloured microfiber, polyester backing, looped yarn, with flaps 2 holes

REF.	NOTES	PCK	VOLUME (m³)	GROSS WEIGHT (kg)	SIZE (cm) ↓ ↓ ↓
0000121AA		25	0,028	3,53	40x13
0000121BB		25	0,028	3,53	40x13
0000121CC		25	0,028	3,53	40x13
0000121FF		25	0,028	3,53	40x13



Ideal for industrial floors, natural stones, single-fired tiles and stoneware with a medium-high degree of dirt

SPEEDY RAPIDO microfiber mop, polyester backing, looped yarn, with external flaps 2 holes

REF.	NOTES	PCK	VOLUME (m³)	GROSS WEIGHT (kg)	SIZE (cm) ↓ ↓ ↓
8516	for 40 x 11 cm mop holders	25	0,024	3,67	40x13



Ideal for industrial floors, natural stones, single-fired tiles and stoneware with a medium-high degree of dirt



MOP SYSTEM

TAB SYSTEM

POCKET SYSTEM

POCKET-TAB SYSTEM

STRAP TAPE SYSTEM

GLOBO SYSTEM

DUO FACE SYSTEM

DOSING HANDLES

SPEEDY RAPIDO coloured microfibre mop, polyester backing, looped yarn, with external 2-hole flaps



REF.	NOTES		PCK	VOLUME (m³)	GROSS WEIGHT (kg)	SIZE (cm) ↓ ↓ ↓
8516A	for 40 x 11 cm mop holders		25	0,024	3,67	40x13
8516B	for 40 x 11 cm mop holders		25	0,024	3,67	40x13
8516C	for 40 x 11 cm mop holders		25	0,024	3,67	40x13
8516F	for 40 x 11 cm mop holders		25	0,024	3,67	40x13



Ideal for industrial floors, natural stones, single-fired tiles and stoneware with a medium-high degree of dirt

SPEEDY TRIPLO microfibre mop, polyester backing, looped yarn, with external 2-hole flaps



REF.	NOTES	PCK	VOLUME (m³)	GROSS WEIGHT (kg)	SIZE (cm) ↓ ↓ ↓
0000122D	for 40 x 11 cm mop holders	25	0,028	3,53	40x13
0000612D	for mop holders 50 x 13 cm	25	0,033	5,36	50x16

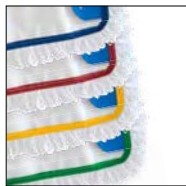

Ideal for any surface with medium-high dirt - Mops with colored borders available on request - Kindly contact our offices for the minimum order quantity

SPEEDY TRIPLO mop made of microfibre, cotton and polyester, with polyester backing, looped yarn, external 2-hole flaps



REF.	NOTES	PCK	VOLUME (m³)	GROSS WEIGHT (kg)	SIZE (cm) ↓ ↓ ↓
0000FS0122D	for 40 x 11 cm mop holders	25	0,024	3,42	40x13

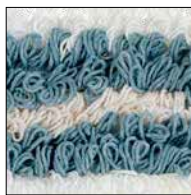

Ideal for any surface with medium-high dirt

SPEEDY MASTER-TUFT cotton mop, polyester backing, tufting, looped yarn, with flaps 2 holes



REF.	NOTES	PCK	VOLUME (m³)	GROSS WEIGHT (kg)	SIZE (cm) ↓ ↓ ↓
00TM0401C00	for 40 x 11 cm mop holders	25	0,028	4,43	40x13
00TM0501C00	for mop holders 50 x 13 cm	25	0,033	5,86	50x16

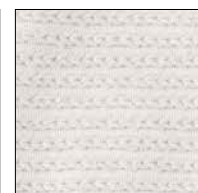

Closed-ring Tufting system - Ideal for any type of surface with a medium degree of dirt and for frequent cleaning.



MOP SYSTEM

TAB SYSTEM

POCKET SYSTEM

POCKET-TAB SYSTEM

STRAP TAPE SYSTEM

GLOBO SYSTEM

DUO FACE SYSTEM

DOSING HANDLES

SPEEDY DREI-TUFT microfiber, cotton and polyester mop, polyester backing, tufting, looped yarn, with flaps 2 holes, with colour-coded tag

REF.	NOTES	PCK	VOLUME (m ³)	GROSS WEIGHT (kg)	SIZE (cm) ↓ ↓ ↓
00TM0414C00	for 40 x 11 cm mop holders	25	0,028	4,68	40x13
00TM0514C00	for mop holders 50 x 13 cm	25	0,043	6,08	50x16

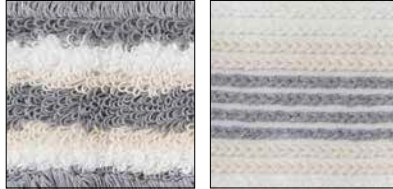

Closed-ring Tufting system - Ideal for any type of surface with a high degree of dirt and deep cleaning.

SPEEDY MICRO-ACTIVA ultra-microfiber mop, polyester backing, with 2-hole flaps and colour-coded tag

REF.	NOTES	PCK	VOLUME (m ³)	GROSS WEIGHT (kg)	SIZE (cm) ↓ ↓ ↓
000EPN07012	for 40 x 11 cm mop holders	25	0,015	2,56	40x13
000EPN07032	for mop holders 50 x 13 cm	25	0,03	3,64	50x16

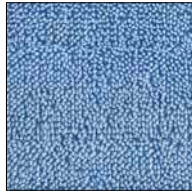

Ideal for industrial floors, single-fired tiles, stoneware and woods with a medium degree of dirt

SPEEDY PULI-SCRUB ultra-microfiber and polypropylene mop, polyester backing, with 2-hole flaps and colour-coded tag

REF.	NOTES	PCK	VOLUME (m ³)	GROSS WEIGHT (kg)	SIZE (cm) ↓ ↓ ↓
000EPN07011	for 40 x 11 cm mop holders	25	0,024	3,37	40x13

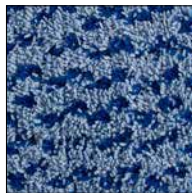

Ideal for scrubbing and wet mopping of non-slip floors and natural terracotta with medium degree of stubborn dirt

SPEEDY PULI-BRUSH ultra-microfiber and polypropylene mop, polyester backing, with 2-hole flaps and colour-coded tag

REF.	NOTES	PCK	VOLUME (m ³)	GROSS WEIGHT (kg)	SIZE (cm) ↓ ↓ ↓
0EPN0418C00A	for 40 x 11 cm mop holders	25	0,019	3,71	40x13
0EPN0418C00B	for 40 x 11 cm mop holders	25	0,019	3,71	40x13

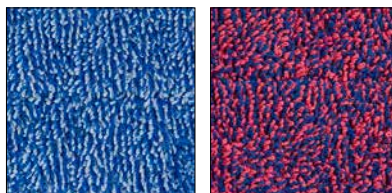

Ideal for scrubbing and washing non-slip surfaces and natural terracotta with a high degree of dirt, characterized by stubborn dirt



MOP SYSTEM

TAB SYSTEM

POCKET SYSTEM

POCKET-TAB SYSTEM

STRAP TAPE SYSTEM

GLOBO SYSTEM

DUO FACE SYSTEM

DOSING HANDLES

SPEEDY ACTIVE-FUR microfiber mop with nylon inserts, polyester backing, 2-hole flaps and colour-coded tags

REF.	NOTES	PCK	VOLUME (m ²)	GROSS WEIGHT (kg)	SIZE (cm) ↓ ↓ ↓
00PN0406C00		25	0,025	3,35	40x13

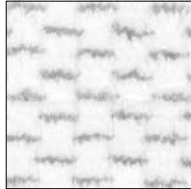

Ideal for light scrubbing and wet mopping of industrial floors, single-fired tiles, stoneware and wooden floors with medium degree of dirt

SPEEDY SKILL-FUR striped microfiber mop, polyester backing, 2-hole flaps and colour-coded tags

REF.	NOTES	PCK	VOLUME (m ²)	GROSS WEIGHT (kg)	SIZE (cm) ↓ ↓ ↓
00PN0413C00		25	0,025	2,85	40x13
00PN0413C00E		25	0,025	2,7	40x13

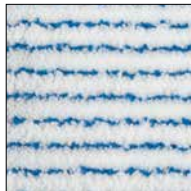

Ideal for industrial surfaces, single-fired tiles and stoneware with a low degree of dirt

Click mop holder

CLICK - mop holder with buttons and joint

REF.	NOTES	PCK	VOLUME (m ²)	GROSS WEIGHT (kg)	SIZE (cm) ↓ ↓ ↓
5544		15	0,035	4,54	44x11



Mops for Click mop holder

Polyester and cotton mop, polyester backing, looped yarn, with flaps fitting Click mop holder

REF.	NOTES	PCK	VOLUME (m ²)	GROSS WEIGHT (kg)	SIZE (cm) ↓ ↓ ↓
8512		25	0,024	3,67	44



Ideal for any surface with medium dirt



MOP SYSTEM

TAB SYSTEM

POCKET SYSTEM

POCKET-TAB SYSTEM

STRAP TAPE SYSTEM

GLOBO SYSTEM

DUO FACE SYSTEM

DOSING HANDLES

Cotton mop, polyester backing, looped yarn, with flaps fitting Click mop holder



REF.	NOTES	PCK	VOLUME (m³)	GROSS WEIGHT (kg)	SIZE (cm)
0C08512		25	0,024	3,67	44

Ideal for any surface with medium dirt



MOP SYSTEM

TAB SYSTEM

POCKET SYSTEM

POCKET-TAB SYSTEM

STRAP TAPE SYSTEM

GLOBO SYSTEM

DUO FACE SYSTEM

DOSING HANDLES

FLOOR CLEANING



As regards the **disinfection with pocket mop system**, Filmop proposes a range of plastic foldable mop holders, including **Click Safe** mop holder.

With Click Safe, combined with the special bucket with lid, there is no need to touch the mop used to release it, therefore preventing hands from turning into vehicles for bacteria and viruses.

The used mop is collected directly into the bag, so the operator does not have to continually bend over to pick it up from the floor.

Click Safe also allows the mop to be attached to the mop holder without effort or hand contact, preventing cross-contamination.

The mop holder is designed to be used with the full range of 40 cm mops with pockets and the Mono-TEX disposable mop, which is ideal for maintaining a high standard of hygiene.

All Filmop mop holders can be equipped with **Lock System** in order to allow the cleaning of walls and ceilings just locking and unlocking the joint simply pushing up and down the special device using one's foot.

HOW TO USE IT



HOW TO REMOVE THE MOP



Fix the mop to the mop holder.



Start mopping the floor.



Insert the mop holder into the bucket with lid.



Lift the mop holder to release the mop.

Mop holders for pocket mop

CLICK SAFE - plastic foldable mop holder

NEW



REF.	NOTES	PCK	VOLUME (m ³)	GROSS WEIGHT (kg)	SIZE (cm)
0000TP0012AU		10	0,024	0,4	40x11



MOP SYSTEM

TAB SYSTEM

POCKET SYSTEM

POCKET-TAB SYSTEM

STRAP TAPE SYSTEM

GLOBO SYSTEM

DUO FACE SYSTEM

DOSING HANDLES

CLICK SAFE - plastic foldable mop holder with Lock System fitting

NEW



REF.	NOTES	PCK	VOLUME (m³)	GROSS WEIGHT (kg)	SIZE (cm) ↓ ↓ ↓
0000TP0312AU		10	0,024	0,4	40x11

CLICK SAFE - plastic foldable mop holder with ErgoSwing fitting

NEW



REF.	NOTES	PCK	VOLUME (m³)	GROSS WEIGHT (kg)	SIZE (cm) ↓ ↓ ↓
0000TP0912AU		10	0,024	4,4	40x11

Use with ErgoSwing system handle, code 0000AM3045 - Learn more about ErgoSwing in the handle section

UNIKO - foldable plastic mop holder with mop fixing clip



REF.	NOTES	PCK	VOLUME (m³)	GROSS WEIGHT (kg)	SIZE (cm) ↓ ↓ ↓
0000TD0020AU		10	0,023	5,39	40x11
0000TD0010AU		10	0,035	9,14	50x13

UNIKO - foldable plastic mop holder with mop fixing clip and Lock System



REF.	NOTES	PCK	VOLUME (m³)	GROSS WEIGHT (kg)	SIZE (cm) ↓ ↓ ↓
0000TD0320AU		10	0,023	5,69	40x11

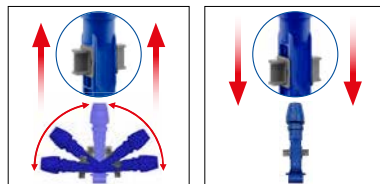

UNIKO - plastic folding mop holder with mop head hook and ErgoSwing joint



REF.	NOTES	PCK	VOLUME (m³)	GROSS WEIGHT (kg)	SIZE (cm) ↓ ↓ ↓
0000TD0920AU		10	0,028	6,05	40x11

Use with ErgoSwing system handle, code 0000AM3045 - Learn more about ErgoSwing in the handle section

Foldable plastic mop holder



REF.	NOTES	PCK	VOLUME (m³)	GROSS WEIGHT (kg)	SIZE (cm) ↓ ↓ ↓
8115U	completely grey	10	0,019	4,66	42x9
8132AB		10	0,023	3,93	40x11
8130AB		10	0,035	6	50x13



MOP SYSTEM

TAB SYSTEM

POCKET SYSTEM

POCKET-TAB SYSTEM

STRAP TAPE SYSTEM

GLOBO SYSTEM

DUO FACE SYSTEM

DOSING HANDLES

Pocket mops

Polyester and cotton pocket mop, polyester backing, looped yarn

REF.	NOTES	PCK	VOLUME (m ²)	GROSS WEIGHT (kg)	SIZE (cm) ↓ ↓ ↓
0000FD2401D	for 40 x 11 cm mop holders	25	0,028	4,68	40x13
8422	for mop holder 40x13 cm	25	0,028	4,93	40x16
8423	for mop holders 50 x 13 cm	25	0,033	6,36	50x16



Ideal for any surface with medium dirt - Mops with colored borders available on request - Contact our offices for minimum quantity

Polyester and cotton pocket mop, polyester backing, looped yarn inside and cut yarn outside

REF.	NOTES	PCK	VOLUME (m ²)	GROSS WEIGHT (kg)	SIZE (cm) ↓ ↓ ↓
0000FD2402D	for 40 x 11 cm mop holders	25	0,028	4,68	40x13
8422/M	for mop holder 40x13 cm	25	0,028	4,93	40x16
8423/M	for mop holders 50 x 13 cm	25	0,033	6,36	50x16

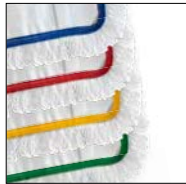

Ideal for any surface with medium dirt - Mops with colored borders available on request - Contact our offices for minimum quantity

Cotton pocket mop, polyester backing, looped yarn

REF.	NOTES	PCK	VOLUME (m ²)	GROSS WEIGHT (kg)	SIZE (cm) ↓ ↓ ↓
0000FD1401D	for 40 x 11 cm mop holders	25	0,028	4,18	40x13
0000FD0501D	for mop holders 50 x 13 cm	25	0,033	5,86	50x16



Ideal for any surface with medium dirt - Mops with colored borders available on request - Contact our offices for minimum quantity

Cotton pocket mop, polyester backing, looped yarn inside and cut yarn outside

REF.	NOTES	PCK	VOLUME (m ²)	GROSS WEIGHT (kg)	SIZE (cm) ↓ ↓ ↓
0000FD1402D	for 40 x 11 cm mop holders	25	0,028	4,18	40x13
0000FD0502D	for mop holders 50 x 13 cm	25	0,033	5,86	50x16



Ideal for any surface with medium dirt - Mops with colored borders available on request - Contact our offices for minimum quantity



MOP SYSTEM

TAB SYSTEM

POCKET SYSTEM

POCKET-TAB SYSTEM

STRAP TAPE SYSTEM

GLOBO SYSTEM

DUO FACE SYSTEM

DOSING HANDLES





RAPIDO - microfiber mop, polyester backing, looped yarn, with pockets

REF.	NOTES	PCK	VOLUME (m ²)	GROSS WEIGHT (kg)	SIZE (cm) ↓ ↓ ↓
0000311D	for 40 x 11 cm mop holders	25	0,028	4,43	40x13
0000511D	for mop holders 50 x 13 cm	25	0,033	5,36	50x16



Ideal for industrial floors, natural stones, single-fired tiles and stoneware with a medium-high degree of dirt

RAPIDO - colored microfiber mop, polyester backing, looped yarn, with pockets

REF.	NOTES	PCK	VOLUME (m ²)	GROSS WEIGHT (kg)	SIZE (cm) ↓ ↓ ↓
0000311AA	for 40 x 11 cm mop holders	 25	0,028	4,68	40x13
0000311BB	for 40 x 11 cm mop holders	 25	0,028	4,68	40x13
0000311CC	for 40 x 11 cm mop holders	 25	0,028	4,68	40x13
0000311FF	for 40 x 11 cm mop holders	 25	0,028	4,68	40x13



Ideal for industrial floors, natural stones, single-fired tiles and stoneware with a medium-high degree of dirt

TRIPLO - microfiber, cotton and polyester mop, polyester backing, looped yarn, with pockets

REF.	NOTES	PCK	VOLUME (m ²)	GROSS WEIGHT (kg)	SIZE (cm) ↓ ↓ ↓
0000312D	for 40 x 11 cm mop holders	25	0,028	4,18	40x13
0000512D	for mop holders 50 x 13 cm	25	0,033	5,86	50x16



Ideal for any surface with medium-high dirt - Mops with colored borders available on request - Kindly contact our offices for the minimum order quantity

MASTER-TUFT - cotton pocket mop, polyester backing, tufting, cut outside

REF.	NOTES	PCK	VOLUME (m ²)	GROSS WEIGHT (kg)	SIZE (cm) ↓ ↓ ↓
00TM0401B00	for 40 x 11 cm mop holders	25	0,028	4,57	40x13
00TM0501B00	for mop holders 50 x 13 cm	25	0,043	6,08	50x16

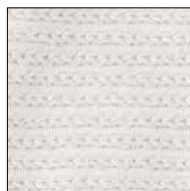

Closed-ring Tufting system - Ideal for any type of surface with a medium degree of dirt and for frequent cleaning.



MOP SYSTEM

TAB SYSTEM

POCKET SYSTEM

POCKET-TAB SYSTEM

STRAP TAPE SYSTEM

GLOBO SYSTEM

DUO FACE SYSTEM

DOSING HANDLES

DREI-TUFT - microfibre, cotton and polyester mop head, polyester backing, tufting, external cut wire, with pockets and colour-coded tag

REF.	NOTES	PCK	VOLUME (m³)	GROSS WEIGHT (kg)	SIZE (cm) ↓ ↓ ↓
00TM0414B00	for 40 x 11 cm mop holders	25	0,028	4,82	40x13
00TM0514B00	for mop holders 50 x 13 cm	25	0,043	6,08	50x16

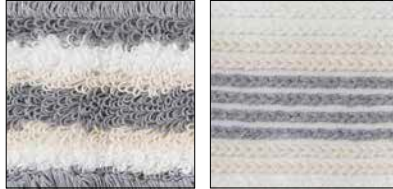

Closed-ring Tufting system - Ideal for any type of surface with a high degree of dirt and deep cleaning.

MICRO-ACTIVA - ultra-microfiber pocket mop, polyester backing, with colour-coded tag

REF.	NOTES	PCK	VOLUME (m³)	GROSS WEIGHT (kg)	SIZE (cm) ↓ ↓ ↓
000EPN04012	for 40 x 11 cm mop holders	25	0,024	2,84	40x13
000EPN06012	for mop holders 50 x 13 cm	25	0,03	3,72	50x16

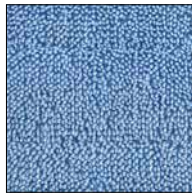

Ideal for industrial floors, single-fired tiles, stoneware and woods with a medium degree of dirt

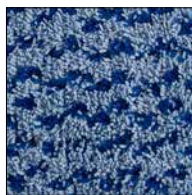

PULI-SCRUB ultra-microfiber and polypropylene pocket mop, polyester backing, with colour-coded tags

REF.	NOTES	PCK	VOLUME (m³)	GROSS WEIGHT (kg)	SIZE (cm) ↓ ↓ ↓
000EPN04011	for 40 x 11 cm mop holders	25	0,024	3,49	40x13



Ideal for scrubbing and wet mopping of non-slip floors and natural terracotta with medium degree of stubborn dirt

PULI-BRUSH - ultra-microfiber and polypropylene pocket mop, polyester backing, with colour-coded tags

REF.	NOTES	PCK	VOLUME (m³)	GROSS WEIGHT (kg)	SIZE (cm) ↓ ↓ ↓
0EPN0418B00A	for 40 x 11 cm mop holders	 25	0,024	2,87	40x13
0EPN0418B00B	for 40 x 11 cm mop holders	 25	0,024	2,87	40x13

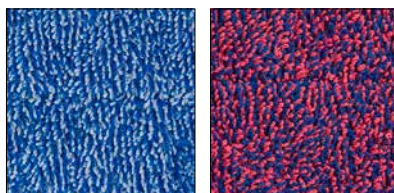

Ideal for scrubbing and washing non-slip surfaces and natural terracotta with a high degree of dirt, characterized by stubborn dirt



MOP SYSTEM

TAB SYSTEM

POCKET SYSTEM

POCKET-TAB SYSTEM

STRAP TAPE SYSTEM

GLOBO SYSTEM

DUO FACE SYSTEM

DOSING HANDLES

ACTIVE-FUR - microfiber pocket mop with nylon inserts, polyester backing and colour-coded tags

REF.	NOTES	PCK	VOLUME (m ³)	GROSS WEIGHT (kg)	SIZE (cm) ↓ ↓ ↓
00PN0406B00	for 40 x 11 cm mop holders	25	0,025	3	40x13
00PN0506B00	for mop holders 50 x 13 cm	25	0,03	4,13	50x16

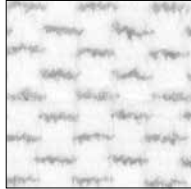

Ideal for light scrubbing and wet mopping of industrial floors, single-fired tiles, stoneware and wooden floors with medium degree of dirt

SKILL-FUR - striped microfiber pocket mop with polyester backing and colour-coded tags

REF.	NOTES	PCK	VOLUME (m ³)	GROSS WEIGHT (kg)	SIZE (cm) ↓ ↓ ↓
00PN0413B00	for 40 x 11 cm mop holders	25	0,025	2,95	40x13
00PN0413B00E	for 40 x 11 cm mop holders	25	0,025	2,95	40x13
00PN0513B00	for mop holders 50 x 13 cm	25	0,03	3,83	50x16
00PN0513B00E	for mop holders 50 x 13 cm	25	0,03	3,5	50x16

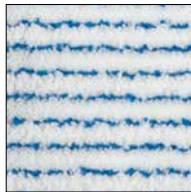

Ideal for industrial surfaces, single-fired tiles and stoneware with a low degree of dirt

MONO-TEX - microfiber disposable pocket mop

REF.	NOTES	PCK	VOLUME (m ³)	GROSS WEIGHT (kg)	SIZE (cm) ↓ ↓ ↓
0000PN03040	pck.: 10 polybags with 50 pcs each	1	0,063	7,33	40



Ideal for hospital interior surfaces with a low degree of dirt. - Semi-disposable: can be washed and reused up to 10 times

Frames for flaps/pockets mops

Foldable plastic mop holder with pockets and flaps

REF.	NOTES	PCK	VOLUME (m ³)	GROSS WEIGHT (kg)	SIZE (cm) ↓ ↓ ↓
0000TP0004AU		10	0,024	4,4	40x11
0000TP0005AU		10	0,035	6,46	50x13





MOP SYSTEM

TAB SYSTEM

POCKET SYSTEM

POCKET-TAB SYSTEM

STRAP TAPE SYSTEM

GLOBO SYSTEM

DUO FACE SYSTEM

DOSING HANDLES

Pocket mops with flaps

Cotton mop with pockets and flaps, polyester backing, looped yarn inside and cut yarn outside

REF.	NOTES	PCK	VOLUME (m ³)	GROSS WEIGHT (kg)	SIZE (cm) ↓ ↓ ↓
00FM0401D00		70	0,056	10,93	40x13
00FM0501D00		50	0,074	12,03	50x16

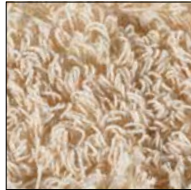

Ideal for any surface with medium dirt

RAPIDO - microfiber mop, polyester backing, looped yarn, with pockets and flaps

REF.	NOTES	PCK	VOLUME (m ³)	GROSS WEIGHT (kg)	SIZE (cm) ↓ ↓ ↓
00FC0402D00		25	0,028	4,69	40x13



Ideal for industrial floors, natural stones, single-fired tiles and stoneware with a medium-high degree of dirt

MASTER-TUFT - cotton mop, polyester backing, tufting, cut outside, with pockets and flaps

REF.	NOTES	PCK	VOLUME (m ³)	GROSS WEIGHT (kg)	SIZE (cm) ↓ ↓ ↓
00TM0401D00		25	0,028	4,68	40x13
00TM0501D00		25	0,043	6,08	50x16



Closed-ring Tufting system - Ideal for any type of surface with a medium degree of dirt and for frequent cleaning.

DREI-TUFT - microfiber, cotton and polyester mop, polyester backing, tufting, cut outside, with pockets and flaps, colour-coded tag

REF.	NOTES	PCK	VOLUME (m ³)	GROSS WEIGHT (kg)	SIZE (cm) ↓ ↓ ↓
00TM0414D00		25	0,028	4,72	40x13
00TM0514D00		25	0,043	6,33	50x16



Closed-ring Tufting system - Ideal for any type of surface with a high degree of dirt and deep cleaning.



MOP SYSTEM

TAB SYSTEM

POCKET SYSTEM

POCKET-TAB SYSTEM

STRAP TAPE SYSTEM

GLOBO SYSTEM

DUO FACE SYSTEM

DOSING HANDLES

FLOOR CLEANING

ACTIVE-FUR - microfiber mop with nylon inserts, polyester backing, pockets and flaps, colour-coded tags

REF.	NOTES	PCK	VOLUME (m³)	GROSS WEIGHT (kg)	SIZE (cm) ↓ ↓ ↓
00PN0406D00		25	0,025	3,18	40x13
00PN0506D00		25	0,031	4,58	50x16

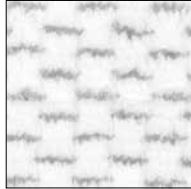

Ideal for light scrubbing and wet mopping of industrial floors, single-fired tiles, stoneware and wooden floors with medium degree of dirt

SKILL-FUR - striped microfiber mop, polyester backing, pockets and flaps, with colour-coded tags

REF.	NOTES	PCK	VOLUME (m³)	GROSS WEIGHT (kg)	SIZE (cm) ↓ ↓ ↓
00PN0413D00		25	0,025	2,75	40x13
00PN0413D00E		25	0,025	3,45	40x13
00PN0513D00		25	0,03	3,75	50x16
00PN0513D00E		25	0,031	3,5	50x16

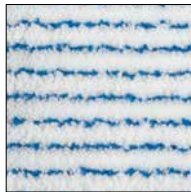

Ideal for industrial surfaces, single-fired tiles and stoneware with a low degree of dirt



MOP SYSTEM

TAB SYSTEM

POCKET SYSTEM

POCKET-TAB SYSTEM

STRAP TAPE SYSTEM

GLOBO SYSTEM

DUO FACE SYSTEM

DOSING HANDLES

Disinfection with strap tape system can be used with all mops with backing with strap tape system, combined with the specific plastic or aluminum mop holder.

Lightweight and resistant, the mop holders feature a trapezoidal shape that makes it easy to clean even hard-to-reach areas and flat edges that ensure excellent adherence to the floor.

The strap tape system offers important advantages: optimal cleaning of floors, walls, and baseboards, less strain, and cost savings due to the possibility of changing profiles without the need to replace the entire tool.



HOW TO USE IT



Fix the mop to the mop holder directly into the TOP-DOWN® bucket.



Start mopping and disinfecting the floor.



Hold mop ends with both feet and pull up the mop holder to remove the mop.



Throw the mop into the provided collection/waste bag.

HOW TO REMOVE THE MOP

All Filmop mop holders can be equipped with **Lock System** in order to allow the cleaning of walls and ceilings just locking and unlocking the joint simply pushing up and down the special device using one's foot.



Unlocked joint:
floor cleaning

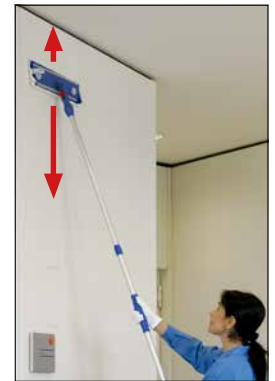

Locked joint:
cleaning of walls and ceilings

Mop holders with strap tape system

Mop holder with strips 2,5 cm for strap tape system



REF.	NOTES	PCK	VOLUME (m³)	GROSS WEIGHT (kg)	SIZE (cm) ↓ ↓ ↓
5263A		10	0,016	2,32	30
5259A		10	0,019	2,92	40
5260A		10	0,03	4,42	60

Mop holder with strips 2,5 cm for strap tape system and with Lock System joint



REF.	NOTES	PCK	VOLUME (m³)	GROSS WEIGHT (kg)	SIZE (cm) ↓ ↓ ↓
5359A		10	0,019	3,64	40
5360A		10	0,03	4,7	60

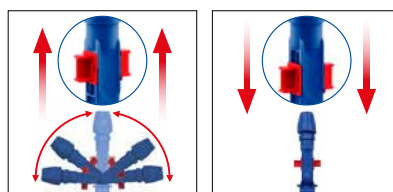



MOP SYSTEM

TAB SYSTEM

POCKET SYSTEM

POCKET-TAB SYSTEM

STRAP TAPE SYSTEM

GLOBO SYSTEM

DUO FACE SYSTEM

DOSING HANDLES

FLOOR CLEANING

Tool for 2.5 cm wide strap tape system profile mops with ErgoSwing joint



REF.	NOTES	PCK	VOLUME (m³)	GROSS WEIGHT (kg)	SIZE (cm) ↓ ↓ ↓
5959A		10	0,028	3,63	40
5960A		10	0,043	5,04	60

Use with ErgoSwing system handle, code 0000AM3045 - Learn more about ErgoSwing in the handle section

Mop holder with strips 1,5 cm for strap tape system



REF.	NOTES	PCK	VOLUME (m³)	GROSS WEIGHT (kg)	SIZE (cm) ↓ ↓ ↓
5278A		10	0,029	5,63	80

Aluminium mop holder with strap tape system strips



REF.	NOTES	PCK	VOLUME (m³)	GROSS WEIGHT (kg)	SIZE (cm) ↓ ↓ ↓
0000TA0030A		12	0,329	3,3	30
0000TA0040A		12	0,018	3,95	40
0000TA0060A		12	0,028	5,44	60



Aluminum mop holder with strips for strap tape system and Lock System joint



REF.	NOTES	PCK	VOLUME (m³)	GROSS WEIGHT (kg)	SIZE (cm) ↓ ↓ ↓
0000TA0340A		12	0,018	4,21	40
0000TA0360A		12	0,028	5,75	60

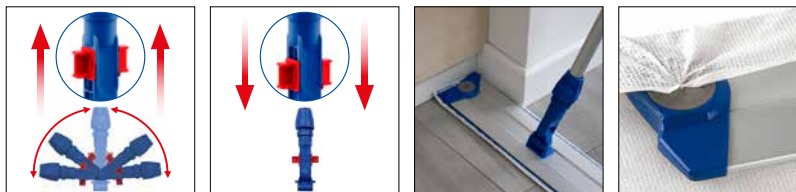

Aluminum mop holder with strips for strap tape system, with ErgoSwing joint



REF.	NOTES	PCK	VOLUME (m³)	GROSS WEIGHT (kg)	SIZE (cm) ↓ ↓ ↓
0000TA0940A		8	0,018	3,13	40
0000TA0960A		8	0,028	4,14	60



Use with ErgoSwing system handle, code 0000AM3045 - Learn more about ErgoSwing in the handle section



MOP SYSTEM

TAB SYSTEM

POCKET SYSTEM

POCKET-TAB SYSTEM

STRAPTape SYSTEM

GLOBO SYSTEM

DUO FACE SYSTEM

DOSING HANDLES

Components for tools with strap tape system

Plastic joint with articulation



REF.	NOTES
4008A	

Lock System plastic joint



REF.	NOTES
4028AB	

Spare strip for strap tape system plastic mop holders



REF.	NOTES
P191085U	for mop holder 30 cm long side (23,3 cm)
P191077U	for mop holder 30 cm short side (20 cm)
P191068U	for mop holder 40 cm long side (35,4 cm)
P191069U	for mop holder 40 cm short side (32 cm)
P191071U	for mop holder 60 cm long side (52,2 cm)
P191070U	for mop holder 60 cm short side (48,6 cm)

Spare strip for strap tape system aluminium mop holders



REF.	NOTES
P191105H	for mop holder 30 cm long side (23.2 cm)
P191104H	for mop holder 30 cm short side (21 cm)
P191107H	for mop holder 40 cm long side (33,1 cm)
P191106H	for mop holder 40 cm short side (31 cm)
P191109H	for mop holder 60 cm long side (52,2 cm)
P191108H	for mop holder 60 cm short side (50,6 cm)



Round cloth star fixing clip



REF.	NOTES
60062U	



MOP SYSTEM

TAB SYSTEM

POCKET SYSTEM

POCKET-TAB SYSTEM

STRAP TAPE SYSTEM

GLOBO SYSTEM

DUO FACE SYSTEM

DOSING HANDLES

Mops for strap tape system

Polyester and cotton mop, cut yarn, with backing for strap tape system

REF.	NOTES	PCK	VOLUME (m ²)	GROSS WEIGHT (kg)	SIZE (cm) ↓ ↓ ↓
5803		25	0,019	2,84	40x10
5807		25	0,03	3,94	60x10



Ideal for any surface with medium dirt

Cotton mop, looped yarn, with backing for strap tape system

REF.	NOTES	PCK	VOLUME (m ²)	GROSS WEIGHT (kg)	SIZE (cm) ↓ ↓ ↓
0000204A		25	0,015	2,06	40x10
0000205A		20	0,015	2,13	60x10



Ideal for any surface with medium dirt

TRIPLO - microfiber, cotton and polyester mop, looped yarn, with backing for strap tape system

REF.	NOTES	PCK	VOLUME (m ²)	GROSS WEIGHT (kg)	SIZE (cm) ↓ ↓ ↓
0000264A		25	0,015	2,19	40x10
0000265A		20	0,015	2,59	60x10



Ideal for any surface with medium-high dirt

TWIST TUFT - microfiber string twine mop, polyester backing, tufting, looped yarn, with strap tape system, colour-coded tag

REF.	NOTES	PCK	VOLUME (m ²)	GROSS WEIGHT (kg)	SIZE (cm) ↓ ↓ ↓
OETC0419A00DD		25	0,024	3,02	40x13



Ideal for all types of floors, both continuous flooring and tiled floors with grouts, with a medium-high degree of dirt



MOP SYSTEM

TAB SYSTEM

POCKET SYSTEM

POCKET-TAB SYSTEM

STRAP TAPE SYSTEM

GLOBO SYSTEM

DUO FACE SYSTEM

DOSING HANDLES

RAPIDO SUPER EXTRA - high-performing white microfiber mop, looped yarn, with colored backing for strap tape system



REF.	NOTES	PCK	VOLUME (m³)	GROSS WEIGHT (kg)	SIZE (cm)
00PN0323A00DA		25	0,011	1,69	30x10
00PN0423A00DA		25	0,015	2,44	40x10
00PN0423A00DB		25	0,015	2,44	40x10
00PN0423A00DC		25	0,015	2,44	40x10
00PN0423A00DF		25	0,015	2,44	40x10
00PN0623A00DA		20	0,015	2,67	60x10



Ideal for industrial floors, natural stones, single-fired tiles and stoneware with a medium-high degree of dirt

RAPIDO SUPER EXTRA - high-performing white microfiber mop for big areas, with backing for strap tape system



REF.	NOTES	PCK	VOLUME (m³)	GROSS WEIGHT (kg)	SIZE (cm)
00PN0823A00DA	for mop holder art. 5201/28 and art. 5278	14	0,015	2,71	80x10
00PN1023A00DA	for mop holder art. 5201/21 and art. 5278	10	0,015	2,39	100x10



Ideal for industrial floors, natural stones, single-fired tiles and stoneware with a medium-high degree of dirt

RAPIDO SUPER - high-performing white microfiber mop, looped yarn, with colored backing for strap tape system

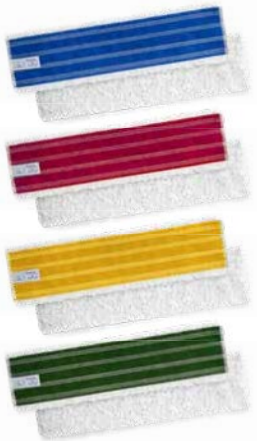

REF.	NOTES	PCK	VOLUME (m³)	GROSS WEIGHT (kg)	SIZE (cm)
00PN0309A00DA		25	0,011	1,39	30x10
00PN0309A00DB		25	0,011	1,39	30x10
00PN0309A00DC		25	0,011	1,39	30x10
00PN0309A00DF		25	0,011	1,39	30x10
00PN0409A00DA		25	0,019	2,09	40x10
00PN0409A00DB		25	0,019	2,09	40x10
00PN0409A00DC		25	0,019	2,09	40x10
00PN0409A00DF		25	0,019	2,09	40x10
00PN0609A00DA		20	0,019	2,42	60x10
00PN0609A00DB		20	0,019	2,42	60x10
00PN0609A00DC		20	0,019	2,42	60x10
00PN0609A00DF		20	0,019	2,42	60x10



Ideal for any surface with medium-high dirt



MOP SYSTEM

TAB SYSTEM

POCKET SYSTEM

POCKET-TAB SYSTEM

STRAP TAPE SYSTEM

GLOBO SYSTEM

DUO FACE SYSTEM

DOSING HANDLES

RAPIDO - colored microfiber mop, looped yarn, with colored backing for strap tape system



REF.	NOTES	PCK	VOLUME (m³)	GROSS WEIGHT (kg)	SIZE (cm)
0000214AA		25	0,015	2,44	40x10
0000214BB		25	0,015	2,44	40x10
0000214CC		25	0,015	2,44	40x10
0000214FF		25	0,015	2,44	40x10



Ideal for industrial floors, natural stones, single-fired tiles and stoneware with a medium-high degree of dirt

DUETTO - microfibre mop with strap tape system and color-coded label

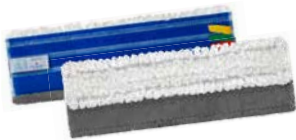

REF.	NOTES	PCK	VOLUME (m³)	GROSS WEIGHT (kg)	SIZE (cm)
0EPN0426A00		25	0,015	2,44	40

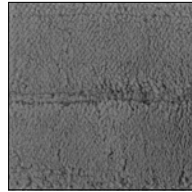

Ideal to dust and wash industrial floors/surfaces, natural stones, single-fired tiles, stoneware with medium-high degree of dirt

MICRO-ACTIVA - ultra-microfiber mop, polyester backing, with strap tape system and colour-coded tag



REF.	NOTES	PCK	VOLUME (m³)	GROSS WEIGHT (kg)	SIZE (cm)
000EPN02012		25	0,011	1,32	30
000EPN03012		25	0,015	1,86	40
000EPN03022		25	0,03	2,77	60

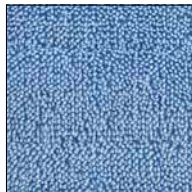

Ideal for industrial floors, single-fired tiles, stoneware and woods with a medium degree of dirt

PULI-SCRUB - ultra-microfiber and polypropylene mop with strap tape system and colour-coded tag

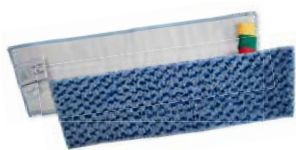

REF.	NOTES	PCK	VOLUME (m³)	GROSS WEIGHT (kg)	SIZE (cm)
000EPN02011		25	0,011	1,49	30
000EPN03011		25	0,015	2,26	40
000EPN03021		25	0,03	3,32	60

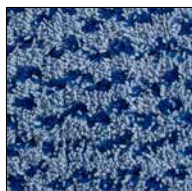

Ideal for scrubbing and wet mopping of non-slip floors and natural terracotta with medium degree of stubborn dirt



MOP SYSTEM

TAB SYSTEM

POCKET SYSTEM

POCKET-TAB SYSTEM

STRAP TAPE SYSTEM

GLOBO SYSTEM

DUO FACE SYSTEM

DOSING HANDLES

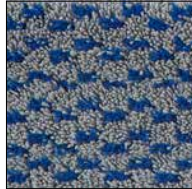

PULI-SCRUB PLUS - Ultra-Microfibre and Polypropylene mop with strap tape system and colour-coded tags, high absorbency

REF.	NOTES	PCK	VOLUME (m³)	GROSS WEIGHT (kg)	SIZE (cm) ↓ ↓ ↓
0EPN0425A00E	suitable for mop holder 40x11 cm	25	0,024	3,17	40x13



Ideal to scrub and wash non-slip floors and natural fired brick with medium-high degree of dirt





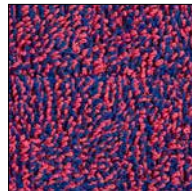
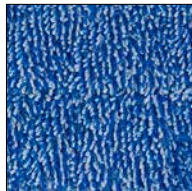



PULI-BRUSH - ultra-microfiber and polypropylene mop, polyester backing, strap tape system and colour-coded tag

REF.	NOTES	PCK	VOLUME (m³)	GROSS WEIGHT (kg)	SIZE (cm) ↓ ↓ ↓
0EPN0418A00A		25	0,015	2,04	40
0EPN0418A00B		25	0,015	2,04	40



Ideal for scrubbing and washing non-slip surfaces and natural terracotta with a high degree of dirt, characterized by stubborn dirt

SMART-FUR - bordered microfiber mop with backing for strap tape system and colour-coded tags

REF.	NOTES	PCK	VOLUME (m³)	GROSS WEIGHT (kg)	SIZE (cm) ↓ ↓ ↓
00PN0403H00		25	0,019	2,34	40
00PN0403H00E		25	0,019	2,24	40
00PN0603H00		20	0,015	2,43	60
00PN0603H00E		20	0,015	2,35	60
00PN0803H00		14	0,015	2,48	80
00PN0803H00E		14	0,025	2,62	80
00PN1003H00		10	0,026	2,19	100
00PN1003H00E		10	0,026	2,19	100

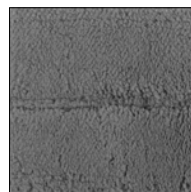

Ideal for any kind of surface with medium degree of dirt - The shock-absorbing border guarantees a better protection for and against baseboards and walls



MOP SYSTEM

TAB SYSTEM

POCKET SYSTEM

POCKET-TAB SYSTEM

STRAP TAPE SYSTEM

GLOBO SYSTEM

DUO FACE SYSTEM

DOSING HANDLES

Rubber brush with plastic grip

REF.	NOTES	PCK	VOLUME (m ²)	GROSS WEIGHT (kg)	SIZE (cm) ↓ ↓ ↓
8112		50	0,033	9	16x5,3x9



Ideal for the maintenance of Smart-Fur mops

ACTIVE-FUR - bordered microfiber mop with nylon inserts, backing for strap tape system and colour-coded tags

REF.	NOTES	PCK	VOLUME (m ²)	GROSS WEIGHT (kg)	SIZE (cm) ↓ ↓ ↓
00PN0406H00		25	0,019	2,34	40
00PN0606H00		20	0,015	2,43	60



Ideal for light scrubbing and washing of industrial, single-fired floors, stoneware and wood floors with a medium degree of dirt. The shock-absorbing border guarantees a better protection for and against baseboards and walls.

SKILL-FUR - striped bordered microfiber mop, backing for strap tape system and colour-coded tags

REF.	NOTES	PCK	VOLUME (m ²)	GROSS WEIGHT (kg)	SIZE (cm) ↓ ↓ ↓
00PN0413H00		25	0,019	1,89	40
00PN0413H00E		25	0,019	1,89	40
00PN0613H00		20	0,015	1,93	60
00PN0613H00E		20	0,015	1,93	60

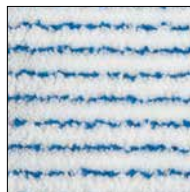

Ideal for industrial floors, single-fired tiles and stoneware with low degree of dirt - The shock-absorbing border guarantees a better protection for and against baseboards and walls

MONO-TEX - microfiber disposable mop, for strap tape system

REF.	NOTES	PCK	VOLUME (m ²)	GROSS WEIGHT (kg)	SIZE (cm) ↓ ↓ ↓
0000PN02040	pck.: 10 polybags with 50 pcs each	1	0,068	6,25	42x14



Ideal for hospital interior surfaces with a low degree of dirt. - Semi-disposable: can be washed and reused up to 10 times



MOP SYSTEM

TAB SYSTEM

POCKET SYSTEM

POCKET-TAB SYSTEM

STRAP TAPE SYSTEM

GLOBO SYSTEM

DUO FACE SYSTEM

DOSING HANDLES

MONO-TNT - TNT disposable mop, for strap tape system



REF.	NOTES	PCK	VOLUME (m³)	GROSS WEIGHT (kg)	SIZE (cm) ↓ ↓ ↓
00PU0415A00	Pck: 10 polybags with 25 pcs each	1	0,034	3,08	40

Ideal for hospital interior surfaces with a low degree of dirt.

Pad for strap tape system mop holders



REF.	NOTES	PCK	VOLUME (m³)	GROSS WEIGHT (kg)	SIZE (cm) ↓ ↓ ↓
8134		5	0,002	0,16	42x9,5



Fitting mop holders with strap tape system and disposable cloths

Mop holders with Microplast strips

Cloth holder with **MICROPLAST** strips



REF.	NOTES	PCK	VOLUME (m³)	GROSS WEIGHT (kg)	SIZE (cm) ↓ ↓ ↓
5264A		10	0,019	3,22	40

Cloth holder with strips **MICROPLAST**, with Lock System



REF.	NOTES	PCK	VOLUME (m³)	GROSS WEIGHT (kg)	SIZE (cm) ↓ ↓ ↓
5364A		10	0,019	3,52	40

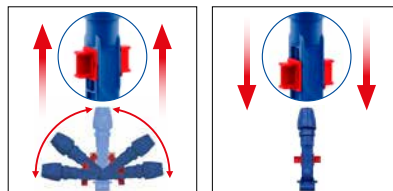

MONO-TEX - microfiber disposable mop, for strap tape system



REF.	NOTES	PCK	VOLUME (m³)	GROSS WEIGHT (kg)	SIZE (cm) ↓ ↓ ↓
0000PN02040	pck.: 10 polybags with 50 pcs each	1	0,068	6,25	42x14

Ideal for hospital interior surfaces with a low degree of dirt. - Semi-disposable: can be washed and reused up to 10 times



MOP SYSTEM

TAB SYSTEM

POCKET SYSTEM

POCKET-TAB SYSTEM

STRAP TAPE SYSTEM

GLOBO SYSTEM

DUO FACE SYSTEM

DOSING HANDLES

MONO-TNT - TNT disposable mop, for strap tape system



REF.	NOTES	PCK	VOLUME (m ²)	GROSS WEIGHT (kg)	SIZE (cm) ↓ ↓ ↓
00PU0415A00	Pck: 10 polybags with 25 pcs each	1	0,034	3,08	40

Ideal for hospital interior surfaces with a low degree of dirt.

Pad for strap tape system mop holders



REF.	NOTES	PCK	VOLUME (m ²)	GROSS WEIGHT (kg)	SIZE (cm) ↓ ↓ ↓
8134		5	0,002	0,16	42x9,5



Fitting mop holders with strap tape system and disposable cloths

Components for tools with Microplast

Plastic joint with articulation



REF.	NOTES
4008A	

Lock System plastic joint



REF.	NOTES
4028AB	

Strip for mop holder **MICROPLAST**



REF.	NOTES
P291050H	short side (31,7 cm)
P291051H	long side (35,3 cm)



MOP SYSTEM

TAB SYSTEM

POCKET SYSTEM

POCKET-TAB SYSTEM

STRAP TAPE SYSTEM

GLOBO SYSTEM

DUO FACE SYSTEM

DOSING HANDLES

Boundless cleaning all-in-one

Filmop has developed a cleaning system that goes beyond the geographic boundaries and habits in the cleaning world: **Globo** is the first and only **universal wet mopping system** that can be used as any traditional system, obtaining superior results in terms of performance, hygiene and ergonomics.

It adapts to the needs of operators who can continue to work using their preferred method (strap tape system, pockets, pockets-flaps) with the advantage to work with a single **more ergonomic, hygienic and practical** system.

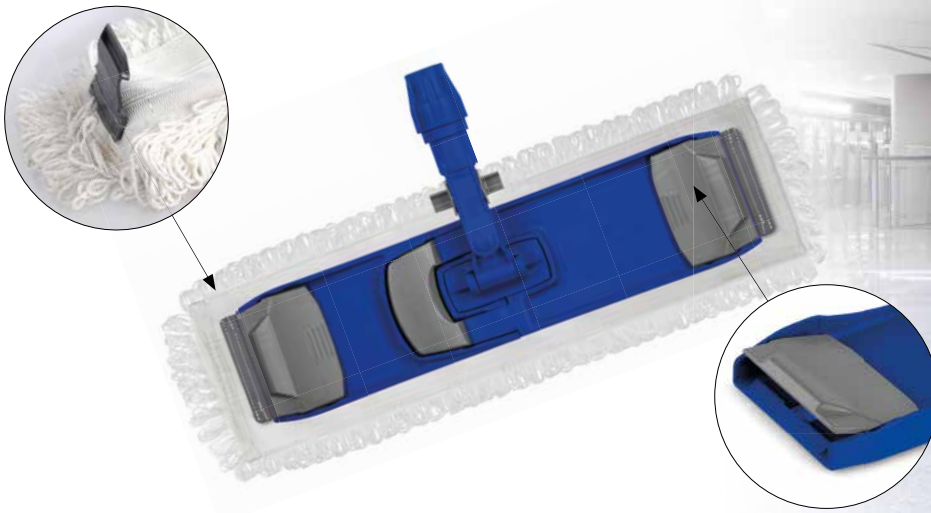

Globo system, composed of one **foldable mop holder** and one **mop with micro flaps**, has been designed to **make cleaning operations easier assuring the highest hygiene**:

- **It makes the mop fixing and release operations quicker and easier**, obtaining a cleaning process optimization, a considerable working time reduction and less efforts in comparison with traditional cleaning systems.
- **100% touch-free system: touchless** fixing and release of the mop from the mop holder, thus **reducing the cross contamination risk**.
- **It prevents fatigue**: the operator always works in conditions of maximum ergonomics; this system allows indeed to avoid continuous bending and a wrong posture during the cleaning operations.
- It can be used with any wet mopping system: **soaking on demand, pre-soaking or traditional wringing system**, ensuring high performances.

Strap tape system
Pocket system



Pocket-tab system



Tab system





MOP SYSTEM

TAB SYSTEM

POCKET SYSTEM

POCKET-TAB SYSTEM

STRAP TAPE SYSTEM

GLOBO SYSTEM

DUO FACE SYSTEM

DOSING HANDLES

FLOOR CLEANING

Globo mop holders

GLOBO mop holder- foldable plastic mop holder



REF.	NOTES	PCK	VOLUME (m³)	GROSS WEIGHT (kg)	SIZE (cm) ↓ ↓ ↓
0000TP0009AU		10	0,024	5,26	40x11

GLOBO mop holder- foldable plastic mop holder with Lock System joint



REF.	NOTES	PCK	VOLUME (m³)	GROSS WEIGHT (kg)	SIZE (cm) ↓ ↓ ↓
0000TP0309AU		10	0,024	5,52	40x11

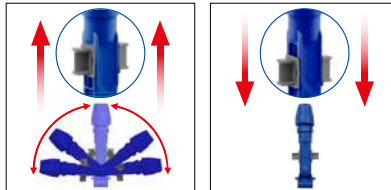

GLOBO mop holder- foldable plastic mop holder with ErgoSwing joint



REF.	NOTES	PCK	VOLUME (m³)	GROSS WEIGHT (kg)	SIZE (cm) ↓ ↓ ↓
0000TP0909AU		10	0,028	5,53	40x11

Use with ErgoSwing system handle, code 0000AM3045 - Learn more about ErgoSwing in the handle section

Globo mops

GLOBO COTTON cotton mop with polyester backing, looped yarn inside, cut yarn outside, with micro flaps



REF.	NOTES	PCK	VOLUME (m³)	GROSS WEIGHT (kg)	SIZE (cm) ↓ ↓ ↓
00FM0401K00		25	0,028	4,73	40x13

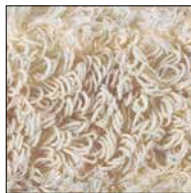

Ideal for any surface with medium dirt



MOP SYSTEM

TAB SYSTEM

POCKET SYSTEM

POCKET-TAB SYSTEM

STRAP TAPE SYSTEM

GLOBO SYSTEM

DUO FACE SYSTEM

DOSING HANDLES

GLOBO TRIPLO mop, microfibre, cotton and polyester, polyester backing, looped yarn, with micro flaps and colour-coded tags

REF.	NOTES	PCK	VOLUME (m ³)	GROSS WEIGHT (kg)	SIZE (cm) ↓ ↓ ↓
00FC0417K00		25	0,024	4,82	40x13



Ideal for any surface with medium-high dirt

GLOBO RAPIDO microfibre mop with polyester backing, looped yarn, micro flaps and color-coded tags

REF.	NOTES	PCK	VOLUME (m ³)	GROSS WEIGHT (kg)	SIZE (cm) ↓ ↓ ↓
00FC0402K00		25	0,024	4,77	40x13



Ideal for industrial floors, natural stones, single-fired tiles and stoneware with a medium-high degree of dirt

GLOBO MICRO-ACTIVA ultra-microfibre mop with polyester backing, micro flaps and color-coded tags

REF.	NOTES	PCK	VOLUME (m ³)	GROSS WEIGHT (kg)	SIZE (cm) ↓ ↓ ↓
0EPN0404K00		25	0,015	2,54	40x13

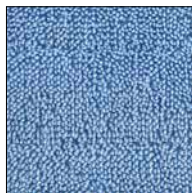

Ideal for industrial floors, single-fired tiles, stoneware and woods with a medium degree of dirt

GLOBO PULI-SCRUB ultra-microfibre and polypropylene mop with polyester backing, micro flaps and colour-coded tags

REF.	NOTES	PCK	VOLUME (m ³)	GROSS WEIGHT (kg)	SIZE (cm) ↓ ↓ ↓
0EPN0412K00		25	0,019	3,44	40x13

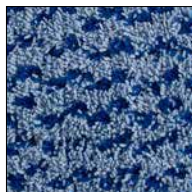

Ideal for scrubbing and wet mopping of non-slip floors and natural terracotta with medium degree of stubborn dirt



MOP SYSTEM

TAB SYSTEM

POCKET SYSTEM

POCKET-TAB SYSTEM

STRAP TAPE SYSTEM

GLOBO SYSTEM

DUO FACE SYSTEM

DOSING HANDLES

GLOBO PULI-BRUSH ultra-microfibre and polypropylene mop with polyester backing, micro flaps and colour-coded tags



REF.	NOTES	PCK	VOLUME (m³)	GROSS WEIGHT (kg)	SIZE (cm) ↓ ↓ ↓
0EPN0418K00A		25	0,024	3,17	40x13
0EPN0418K00B		25	0,024	3,17	40x13

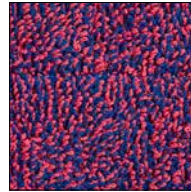
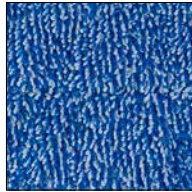

Ideal for scrubbing and washing non-slip surfaces and natural terracotta with a high degree of dirt, characterized by stubborn dirt

GLOBO ACTIVE-FUR microfibre mop with nylon inserts, polyester backing, micro flaps and colour-coded tags



REF.	NOTES	PCK	VOLUME (m³)	GROSS WEIGHT (kg)	SIZE (cm) ↓ ↓ ↓
00PN0406K00		25	0,025	2,82	40x13



Ideal for light scrubbing and wet mopping of industrial floors, single-fired tiles, stoneware and wooden floors with medium degree of dirt

GLOBO SKILL-FUR microfibre mop with stripes, polyester backing, micro flaps and colour-coded tags



REF.	NOTES	PCK	VOLUME (m³)	GROSS WEIGHT (kg)	SIZE (cm) ↓ ↓ ↓
00PN0413K00		25	0,025	2,45	40x13
00PN0413K00E		25	0,025	2,57	40x13

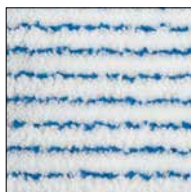

Ideal for industrial surfaces, single-fired tiles and stoneware with a low degree of dirt



MOP SYSTEM

TAB SYSTEM

POCKET SYSTEM

POCKET-TAB SYSTEM

STRAPTAPE SYSTEM

GLOBO SYSTEM

DUO FACE SYSTEM

DOSING HANDLES

Turn and double the face of clean!



Duo Face is the innovating combined system (mop holder + mops) designed by Filmop to simplify and optimize the cleaning of floors and vertical surfaces.

The **reversible mop holder** and the **range of double-faced mops** allow **to double the efficiency** of the cleaning operations with one single system.



Reversible mop holder

- Make full use of the double mop holder thanks to its two perfectly flat and reversible sides
- Fix the mop to the mop holder with 2 simple clicks: the special raised central part allows to insert the mop in the right position, its serrated external borders assure a stable and non-slip mop fixing
- Avoid any contact of the mop with your hands thanks to its foot-operated pedal devices
- Clean also the vertical surfaces very easily thanks to the Lock System technology
- Do not waste your strength: the central joint distributes the pressure uniformly onto the whole surface of the mop holder



Double-faced mops

The two mop sides are made of 100% cleaning surface and matched together thanks to a special ultrasonic welding that makes seamless Duo Face mops **much more resistant** and **more hygienic**, as they have no pockets or extra material where dirt and bacteria would hide and grow.



Duo Face mops are **perfectly reversible**:

- **Turn the mop and double the square meters of surface**: use the first side of the mop, turn it and go on with the second side. 1 traditional mop cleans about 25 sqm, 1 Duo Face mop: 50 sqm.
- **Turn the mop and double the possible cleaning operations**: wash, turn and dry! Duo Face BARRIER mops are made with a special **waterproof barrier** inside that separates the two cleaning sides of the mop. Dry and wet finally together in one single mop.

Duo Face ultra-microfibers

Duo Face mops are the outcome of a long and **careful planning** that has involved Filmop R&D department for a long time to reach the best final result: a wide range of double-faced mops to satisfy several and different cleaning needs, manufactured with **completely Made in Italy** and **high quality microfiber** material.

Duo Face microfibers guarantee the maximum performance concerning **collection of dirt, release of dirt** during washing, **mop running, quality** of final cleaning results, **durability and mop lifetime**.

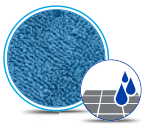

WASH BASIC:
standard wet mopping

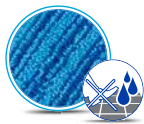

WASH SAFE E SAFE:
wet mopping non-slip floors

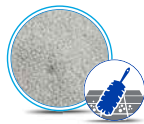

DUST:
dry dusting

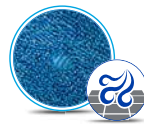

DRY:
drying

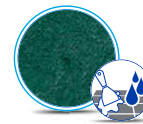

SCRUBLY:
scrubbing

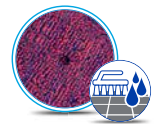

WASH BRUSH E BRUSH:
removal of stubborn dirt

Duo Face mop holders

DUO FACE - reversible plastic mop holder with Lock System



REF.	NOTES	PCK	VOLUME (m³)	GROSS WEIGHT (kg)	SIZE (cm)
0000TP0303U		5	0,009	3,62	40x10,5



MOP SYSTEM

TAB SYSTEM

POCKET SYSTEM

POCKET-TAB SYSTEM

STRAP TAPE SYSTEM

GLOBO SYSTEM

DUO FACE SYSTEM

DOSING HANDLES

Duo Face mops

DUO FACE WASH BASIC - ultra-microfibre double-faced mop, floor wet mopping

REF.	NOTES	PCK	VOLUME (m³)	GROSS WEIGHT (kg)	SIZE (cm) ↓ ↓ ↓
0EPD04L0L00AA		10	0,013	1,35	46x19,5
0EPD04L0L00AB		10	0,013	1,35	46x19,5
0EPD04L0L00BB		10	0,013	1,35	46x19,5
0EPD04L0L00CC		10	0,013	1,35	46x19,5
0EPD04L0L00FF		10	0,013	1,35	46x19,5

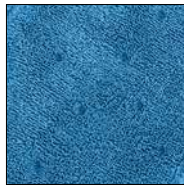

Ideal for industrial floors, single-fired tiles, stoneware and woods with a medium degree of dirt

DUO FACE WASH SAFE - microfiber double-faced mop, wet mopping on non-slip floors

REF.	NOTES	PCK	VOLUME (m³)	GROSS WEIGHT (kg)	SIZE (cm) ↓ ↓ ↓
00PD04L1L10AA		10	0,013	1,6	46x19,5

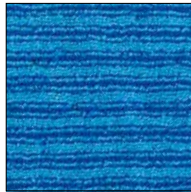

Ideal for non-slip floors with a medium degree of dirt and with stubborn dirt

DUO FACE DUST - ultra-microfibre double-faced mop, dry dusting

REF.	NOTES	PCK	VOLUME (m³)	GROSS WEIGHT (kg)	SIZE (cm) ↓ ↓ ↓
00PD04S0S00EE		10	0,013	1,5	46x19,5

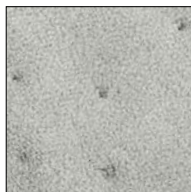

DUO FACE WASH BASIC/ SCRUBLY - microfiber double-faced mop, wet mopping / scrubbing action

REF.	NOTES	PCK	VOLUME (m³)	GROSS WEIGHT (kg)	SIZE (cm) ↓ ↓ ↓
00PD04L0L30AF		10	0,013	1,55	46x19,5
00PD04L0L30BF		10	0,013	1,55	46x19,5

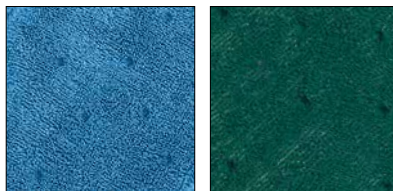
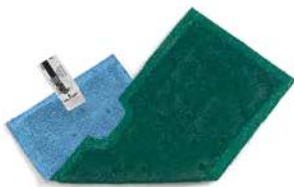

Ideal for industrial surfaces, single-fired tiles and stoneware with Wash Basic side and anti-slip surfaces with Scrubly side, with a medium degree of dirt and with stubborn dirt



MOP SYSTEM

TAB SYSTEM

POCKET SYSTEM

POCKET-TAB SYSTEM

STRAP TAPE SYSTEM

GLOBO SYSTEM

DUO FACE SYSTEM

DOSING HANDLES

DUO FACE WASH BASIC/ SAFE - microfiber double-faced mop, wet mopping/wet mopping on non-slip floors

REF.	NOTES	PCK	VOLUME (m³)	GROSS WEIGHT (kg)	SIZE (cm) ↓ ↓ ↓
00PD04L0L10AA		10	0,013	1,45	46x19,5
00PD04L0L10AB		10	0,013	1,45	46x19,5

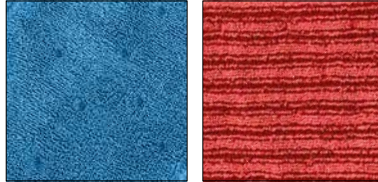

Ideal for industrial floors, single-fired tiles and stoneware Wash Basic side and non-slip floors Safe side, with a medium degree of dirt and stubborn dirt

DUO FACE WASH BRUSH - ultra-microfiber double-faced mop, non-slip wet mopping

REF.	NOTES	PCK	VOLUME (m³)	GROSS WEIGHT (kg)	SIZE (cm) ↓ ↓ ↓
0EPD04L5L50AA		10	0,013	1,54	46x19,5
0EPD04L5L50BB		10	0,013	1,54	46x19,5

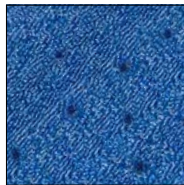

Ideal for scrubbing and washing non-slip surfaces and natural terracotta with a high degree of dirt, characterized by stubborn dirt

DUO FACE WASH BASIC / BRUSH - ultra-microfiber double-faced mop, wet mopping/non-slip

REF.	NOTES	PCK	VOLUME (m³)	GROSS WEIGHT (kg)	SIZE (cm) ↓ ↓ ↓
0EPD04L0L50AA		10	0,013	1,54	46x19,5
0EPD04L0L50AB		10	0,013	1,54	46x19,5

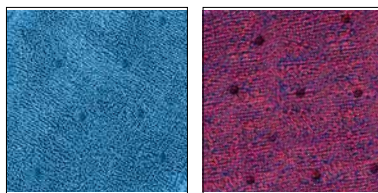

Wash Basic side ideal for industrial surfaces/floors, single-fired tiles and stoneware. Brush side ideal for scrubbing, non-slip floors and natural terracotta with high degree of stubborn dirt

DUO FACE WASH BASIC / DRY BARRIER - microfiber double-faced mop, wet mopping/dry, with waterproof barrier

REF.	NOTES	PCK	VOLUME (m³)	GROSS WEIGHT (kg)	SIZE (cm) ↓ ↓ ↓
00PD04L0A01AA		10	0,013	1,7	46x19,5
00PD04L0A01AB		25	0,028	2,92	46x19,5

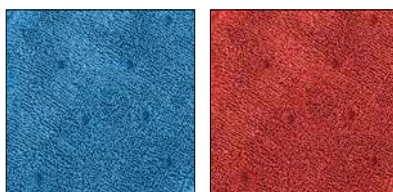

Ideal for industrial floors, single-fired tiles, stoneware and woods with a medium degree of dirt



Unilav is a wet mopping and/or disinfection tool for medium small areas, such as stairs, offices, bars, small shops with a medium degree of dirt. It is very useful for quick actions. In combination with microfiber cloths or with disposable cloths, it guarantees excellent cleaning results. Very simple and quick to use, light, handy and ergonomic.



Two types of refilling bottle: 650 ml and 1000 ml in different colours: red, blue, green and yellow.



The side-grip allows to regulate the release of cleaning solution: continuous flow or intermittent flow.

In order to have a complete disinfection system, Filmop offers also a **Unilav kit** that allows the operator to carry all the necessary equipment during the cleaning operations, optimizing working time.

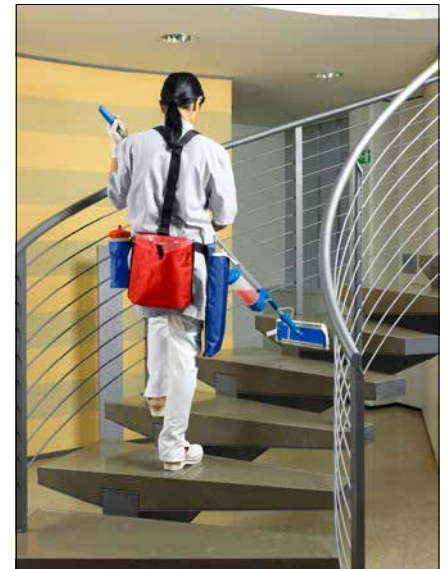

Safety tool is equipped with a special pierced "flowthrough" plate that allows a uniform distribution of the cleaning solution on the floor, thus avoiding waste of product.

HOW TO PREPARE IT

HOW TO USE IT

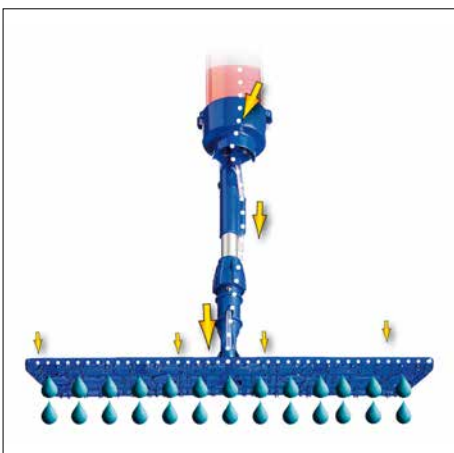

Lift up the plastic cover and fix it to the handle grip.



Fill in the tank.



Press and release the knob at the top of the grip for an intermittent wax flowing; press and block the knob for a continuous wax flowing.



The rubber cover on the knob on the handle grip avoids dirt and bacteria inside the hole and guarantees a more stable leaning of the tool against the walls.



MOP SYSTEM

TAB SYSTEM

POCKET SYSTEM

POCKET-TAB SYSTEM

STRAP TAPE SYSTEM

GLOBO SYSTEM

DUO FACE SYSTEM

DOSING HANDLES

Simple, quick and efficient cleaning

DROP

Drop is a **professional floor cleaning system** complete with tank handle with 500 ml capacity, aluminium mop holder and Skill-Fur microfibre mop.

Light, handy and easy to use, particularly advised for the cleaning in **medium-small environments** and in all those situations where a **fast and quick action** is required.

This system is characterized by a **well-finished, treated in detail design** for the highest practicality, speed and safety:

- **Intuitive, light and handy**, it reduces the operator's efforts and working time
- It allows to **dose the detergent solution** according to the surface and the degree of dirt
- **It avoids the leak of the detergent solution** thanks to the locking screw of the tank
- Its compact size allows to **clean easily also the hard-to reach areas**
- The reduced overall dimensions help to **store it easily even in the smallest closets** at the end of the cleaning operations

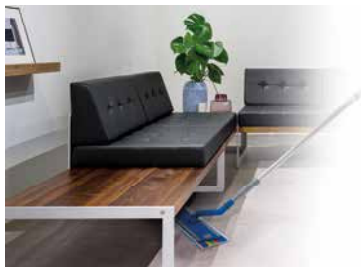

Drop



ERGODROP

ErgoDrop

ErgoDrop combines the advantages of the professional Drop system with those of the innovative ergonomic ErgoSwing system, ensuring **maximum results with minimum effort**.

ErgoDrop **is designed to prevent the onset of professional illnesses**: the 360° rotation of the grips and the ergonomic design of the mop holder joint guarantee the health and well-being of the operator.

- **It doesn't force the operator to assume uncomfortable or asymmetrical positions**: it makes the S-movement easier, ensuring a correct posture during the cleaning operations.
- **It doesn't oblige the operator to make extreme wrist movements**: it reduces remarkably wrist flexion and extension movements compared to traditional systems, preventing fatigue.



ERGOSWING JOINT





Unilav Side Grip

UNILAV SIDE GRIP - disinfection tool with refilling bottle 650 ml and Duo Face mop holder





REF.	NOTES	PCK	VOLUME (m³)	GROSS WEIGHT (kg)
0000TD0120A		1	0,039	2,26



UNILAV SIDE GRIP - flat mop with 650ml bottle and holder with strap tapes



REF.	NOTES	PCK	VOLUME (m³)	GROSS WEIGHT (kg)
0000TD0151A	with plate 40 cm 	1	0,038	1,97
0000TD0151U	with plate 40 cm 	1	0,038	2,57
0000TD0161A	with plate 60 cm 	1	0,038	2,57



UNILAV SIDE GRIP - disinfection tool with refilling bottle 650 ml and cloth holder with Microplast strips 40 cm



REF.	NOTES	PCK	VOLUME (m³)	GROSS WEIGHT (kg)
0000TD0145A		1	0,038	2,47





MOP SYSTEM

TAB SYSTEM

POCKET SYSTEM

POCKET-TAB SYSTEM

STRAP TAPE SYSTEM

GLOBO SYSTEM

DUO FACE SYSTEM

DOSING HANDLES

UNILAV SIDE GRIP - disinfection tool with refilling bottle 650 ml and cloth holder with rubber lamellas 40 cm



REF.	NOTES	PCK	VOLUME (m³)	GROSS WEIGHT (kg)
0000TD0130A		1	0,038	2,23



MONO-TNT YELLOW - TNT disposable mop



REF.	NOTES	PCK	VOLUME (m³)	GROSS WEIGHT (kg)	SIZE (cm)
0000PN02030	Pck: 10 polybags with 25 pcs each	1	0,028	2,7	20x42,5

For tools with blade plate

Safety

SANETY - disinfection tool with bottle 1,5 L



REF.	NOTES	PCK	VOLUME (m³)	GROSS WEIGHT (kg)
8149	with plate 60 cm	1	0,038	2,51

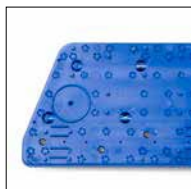

Disinfection mop for Sanety tool, mixed cotton



REF.	NOTES	PCK	VOLUME (m³)	GROSS WEIGHT (kg)	SIZE (cm)
8136		100	0,055	8,73	65x15



MOP SYSTEM

TAB SYSTEM

POCKET SYSTEM

POCKET-TAB SYSTEM

STRAP TAPE SYSTEM

GLOBO SYSTEM

DUO FACE SYSTEM

DOSING HANDLES

FLOOR CLEANING

Drop - ErgoDrop

Kit **DROP** - tank handle 500 ml with aluminium mop holder 40 cm with strips for strap tape system, bordered Skill-Fur microfiber mop and dosing jug



REF.	NOTES	PCK	VOLUME (m³)	GROSS WEIGHT (kg)
0002TD0652A		1	0,019	1,59



Kit **ERGODROP** - tank handle 500 ml with aluminium mop holder 40 cm with strips for strap tape system with ErgoSwing fitting, bordered Skill-Fur microfiber mop and dosing jug



REF.	NOTES	PCK	VOLUME (m³)	GROSS WEIGHT (kg)
0002TD0552A		1	0,019	1,68

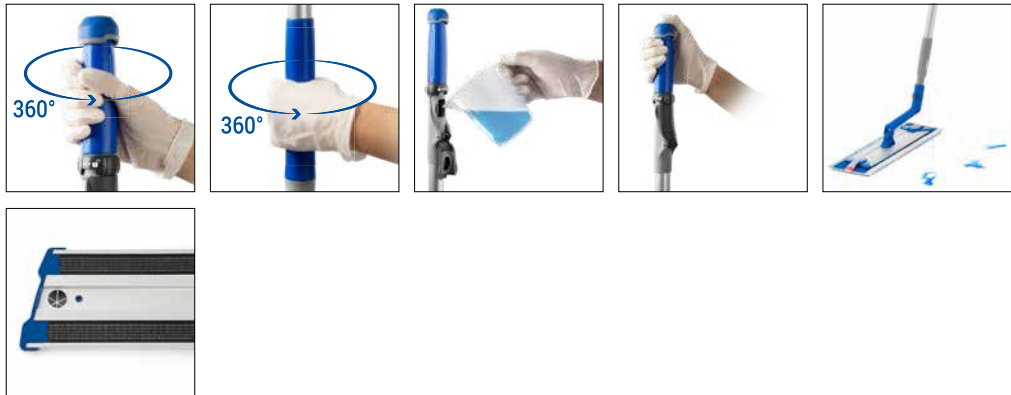



MOP SYSTEM

TAB SYSTEM

POCKET SYSTEM

POCKET-TAB SYSTEM

STRAP TAPE SYSTEM

GLOBO SYSTEM

DUO FACE SYSTEM

DOSING HANDLES

Components and accessories for dosing handles

Belt for Unilav kit



REF.

NOTES

Q0400108



Blue plastic-coated bag for clean mops for Unilav kit



REF.

NOTES

Q0400105A

Red plastic-coated bag for dirty mops for Unilav kit



REF.

NOTES

Q0400106B

Blue plastic-coated bottle holder for Unilav kit



REF.

NOTES

Q0400107A

Transparent refilling bottle with coloured screw cap for Unilav tool



REF.	NOTES	CAPACITY (L)	SIZE (cm) ↓ ↓ ↓
P291029A		0,65	25,5
P291029B		0,65	25,5
P291029C		0,65	25,5
P291029F		0,65	25,5
P291030A		1	34
P291030B		1	34
P291030C		1	34
P291030F		1	34



MOP SYSTEM

TAB SYSTEM

POCKET SYSTEM

POCKET-TAB SYSTEM

STRAPTAPE SYSTEM

GLOBO SYSTEM

DUO FACE SYSTEM

DOSING HANDLES

FLOOR CLEANING

DROP - tank handle 500 ml



REF.	NOTES	PCK	VOLUME (m³)	GROSS WEIGHT (kg)	SIZE (cm) ↓ ↓ ↓
0000TD0600A		5	0,019	3,19	142



ERGODROP - tank handle 500 ml with turning grips for ErgoSwing system



REF.	NOTES	PCK	VOLUME (m³)	GROSS WEIGHT (kg)	SIZE (cm) ↓ ↓ ↓
0000TD0500A		5	0,019	3,41	142



Graduated plastic jar



REF.	NOTES	PCK	VOLUME (m³)	GROSS WEIGHT (kg)
P191000T	3L	12	0,073	2,96
P192000T	0,5L	80	0,079	3,84

Blue rubber cover for knob for Sanety and Slider tools



REF.	NOTES
P191084A	

Silicon tube



REF.	NOTES	SIZE (cm) ↓ ↓ ↓
P191045T	for Unilav tool	36
P191021T	for Sanety tool	40

Mop soaking systems



Mop soaking on demand and pre-soaking system



WHY CHOOSE A MOP SOAKING SYSTEM?

Advantages:

- **Reduced risks of bacterial cross-contamination:** always clean detergent solution and use of one mop for each room
- **Environmentally friendly:** higher control of chemical solution with reduced chemical and water waste, lower environmental impact if compared with traditional mopping systems employing bucket and mop
- **Better ergonomics:** no rinsing and wringing; consequently, less effort for the operator and reduced costs for industrial accidents and illness leaves
- **Easy to use:** simple to use, systems that make it easier to train the staff
- **Reduced costs for cleaning:** reduced working hours guarantee reduced labour costs
- **Excellent results in cleaning and hygiene:** thanks to the combination of mop soaking system and microfiber

MOP SOAKING SYSTEMS

1 Mop soaking system on demand:

Single mop soaking on demand directly on the trolley by means of the specific Equodose dosing station.

2 Pre-soaking system:

Pre-soaking system in advance, preparing the mops before use, normally in specific places, employing hermetic **Top-Down®** buckets or **plastic drawers**.



EQUODOSE system



TOP-DOWN® system



System with drawers

COMPATIBILITY

Filmop mop soaking systems fit:



Strap tape system



Pocket mop system



Duo Face system



Click Safe System

Mop soaking system on demand



Alpha

Pre-soaking system



Vega Top-Down®



Arka Top-Down®



Morgan Top-Down®



Alpha



MOP SOAKING ON DEMAND AND PRE-SOAKING SYSTEM

EQUODOSE®

PATENTED SYSTEM



Equodose is the innovating **mechanical dosing device** developed by Filmop to make the **mop soaking on demand** directly on site. This system is designed with an **adjustable dosing mechanism** according to the features of the mops to use and the surfaces to clean.



Features:

- **Totally mechanical and without electrical parts:** dosage is regulated by means of a graduated dial and operated thanks to a hand lever.
- **Strong and easy to maintain:** made of high quality polypropylene (Made in Italy), easy and low maintenance is required.
- **Safe and as by law enacted:** the graduated dial and tank can be blocked with the specific safety key device to avoid any tampering or improper use; hand lever with push button to block the solution dispensing mechanism.
- **Modular design:** available with 1 or 2 tanks to increase the dosing system autonomy or to operate with two different detergents/cleaning solutions at the same time.
- **Versatile:** fitting Alpha line of trolleys. Suitable for several kinds of mops and mop holders: strap tape system, pocket mop system and Duo Face mop system (only fitting 40 cm mop systems).

Advantages:

- **Prompt and ready in the working place:** mop soaking on demand and directly on site, just the necessary mops, even one single mop!
- **Minimum overall dimensions:** ideal in environments where there is a lack of big spaces to prepare and stock the pre-soaked mops and the hermetic buckets.
- **Eco-friendly product, low environmental impact:** water and detergent saving, as this system allows to soak only the necessary mops, eliminating any unnecessary washing of unused reserve mops in the washing machine. No need of electric power, no need of power supply, made of 100% recyclable plastic.
- **Easy to use:** just a few and simple steps and the mops are ready to use, high intuitive system.
- **Flexible:** you can regulate very accurately the right solution for each single mop according to the features of the surface to clean, the degree of dirt and the absorbing capacity of the mop.
- **High standards of hygiene:** reduction of cross-contamination risks, making easy and simple to clean each room with a different and ever clean mop. Tanks preserve active principles of some chemical solutions that could become less effective over time: this system is ideal for hospitals and healthcare facilities.





MOP SOAKING ON DEMAND AND PRE-SOAKING SYSTEM

Dosing system

Increased flexibility: the 50 ml to 350 ml adjustable system ensures better detergent solution dosing precision also for the lightest cloths, such as surface mops for hand use, further reducing waste

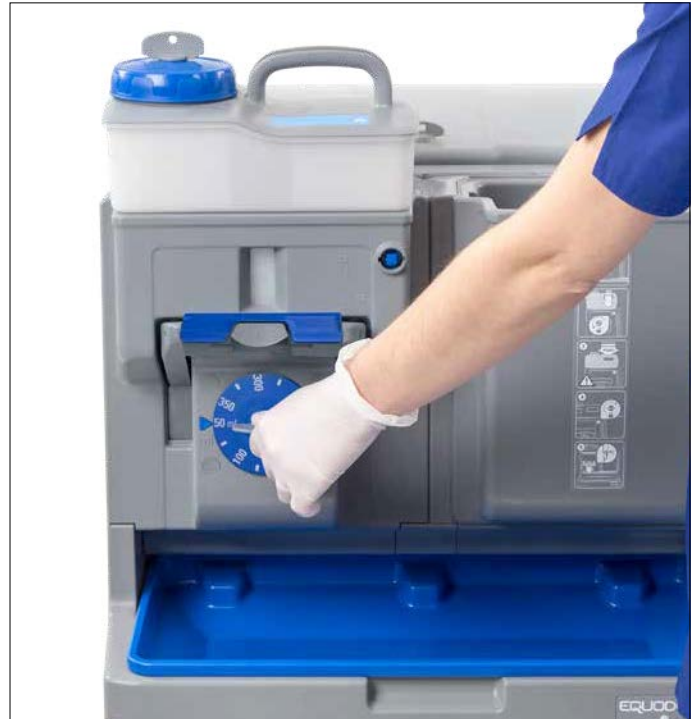

Sealed reservoir

More effective: hermetic tank thanks to the internal washer of the cap, better preservation of the cleaning solution

Higher safety: the cap locking system improves the safety level

Better hygiene: the reservoir design facilitates easy cleaning and good long-term maintenance



How to use it



Rotate the graduated dial from 50 ml to 350 ml to choose the right dose of solution. If necessary, remove the safety key to lock the dial and keep the right dosage.



Push the mechanical hand lever completely down.



Take a clean mop and lay it in the tray ready for soaking with the cleaning side downwards. Wait for a few seconds for a complete and uniform mop soaking. This system is suitable for several kinds of mops, but only for 40 cm mop sizes.



MOP SOAKING ON DEMAND AND PRE-SOAKING SYSTEM

NEW Click Safe: guaranteed hygiene, health protection

Click Safe is a **touchless cleaning system** consisting of folding mop holder and bucket with lid that can be combined with the mesh bag, designed to make operations easier, more hygienic and safer.



The mop holder hooks the mop easily and immediately while the lid instantly releases it directly into the bucket, the operator does not need to touch it with the hands and bend over.

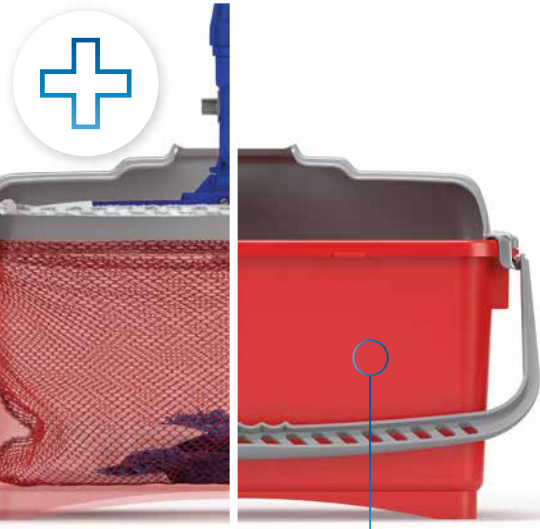

The special bag completes the job: placed in the bucket, it collects used mops making emptying and handling of laundry operations even faster and more hygienic.

plastic
second life
MIX ECO



Combining Click Safe with **soaking systems** helps to maintain a high level of hygiene throughout the cleaning procedure, lowering the risk of cross-contamination.

The Equodose mechanical dispenser for soaking on demand and **Top-Down** hermetic buckets for pre-soaking allow each area to be cleaned with a different mop or cloth while the touchless system allows them to be disposed of effectively preventing the spread of bacteria and viruses.



MOP SOAKING ON DEMAND AND PRE-SOAKING SYSTEM

Equodose

EQUODOSE - dosing device with one tank 6 L for mop soaking on demand



REF.	NOTES	PCK	VOLUME (m³)	GROSS WEIGHT (kg)	SIZE (cm) ↓ ↓ ↓
P320100UA	with EPDM seals	1	0,09	6,01	28x55x55
P320101UA	with Viton seals	1	0,09	6,01	28x55x55

⚠ ATTENTION: only for system 40 cm

EQUODOSE - dosing device with two tanks 6 L for mop soaking on demand



REF.	NOTES	PCK	VOLUME (m³)	GROSS WEIGHT (kg)	SIZE (cm) ↓ ↓ ↓
P320200UA	with EPDM seals	1	0,102	7,6	28x55x55
P320201UA	with Viton seals	1	0,102	7,6	28x55x55

⚠ ATTENTION: only for system 40 cm

Transparent tank 6 L with coloured cap complete with key



REF.	NOTES	PCK	VOLUME (m³)	GROSS WEIGHT (kg)
P210017TA	with EPDM seals		10	0,144
P210017TB	with EPDM seals		10	0,144
P210022TA	with Viton seals		10	0,139
P210022TB	with Viton seals		10	0,139



Tray for mop soaking



REF.	NOTES
P110004A	

Standard key



REF.	NOTES
P110014U	

It allows to regulate the dosage, lock the tank and close the cap



MOP SOAKING ON DEMAND AND PRE-SOAKING SYSTEM

Kit key to dose cleaning solution



REF.	NOTES
0000SM00286	

It allows to regulate the dial independently from the rest of the system with a specific key, different from the standard one - **This option enable to a single operator to adjust the right quantity of cleaning solution**

Grey plastic bucket 4 L with coloured plastic handle on the edge



REF.	NOTES	SIZE (cm)
		↓ ↓ ↓
0000SE0204U	Grey	16,5x21x22,5
0000SE0204UA	Blue	16,5x21x22,5
0000SE0204UB	Red	16,5x21x22,5
0000SE0204UC	Yellow	16,5x21x22,5
0000SE0204UF	Green	16,5x21x22,5



Transparent plastic cover with hinges



REF.	NOTES
0000CP1204T	for bucket 4 L art. 0000SE0104
0000CP1205T	for 4l bucket item no. 0000SE0204
0000CP1206T	for bucket 6 L



Set for Equodose wall mounting



REF.	NOTES
0000SM00612	

Kit to fix Equodose on Morgan trolleys



REF.	NOTES
0000SM00613	

MOP SOAKING ON DEMAND AND PRE-SOAKING SYSTEM

Buckets and drawers for pre-soaking system

TOP-DOWN® - plastic bucket with plastic handle and hermetic cover



REF.	NOTES	CAPACITY (L)	PCK	VOLUME (m³)	GROSS WEIGHT (kg)	SIZE (cm) ↓ ↓ ↓
0000SE1308A		8	5	0,043	3,46	17x36x23
0000SE1308B		8	5	0,043	3,46	17x36x23
0000SE1308C		8	5	0,043	3,46	17x36x23
0000SE1310A		10	5	0,094	7,45	24x55x19
0000SE1310B		10	5	0,094	7,45	24x55x19
0000SE1314A		14	4	0,086	6,63	20x77x18
0000SE1314FT		14	4	0,086	6,63	20x77x18
0000SE1322A		20	4	0,094	6,93	24x55x27
0000SE1322B		20	4	0,094	6,93	24x55x27
0000SE1322U		20	4	0,094	6,93	24x55x27

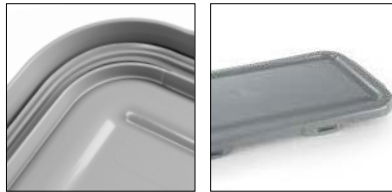

They are the ideal solution for cloth soaking procedures

Plastic divider for Top-Down® bucket 20 L

REF.	NOTES	PCK	VOLUME (m³)	GROSS WEIGHT (kg)
P190350E		5	0,024	2,67



The specific plastic reducer is ideal to keep the mop compact inside the bucket and to make it easier to pick up them from the bucket directly with the mop holder

Pierced plastic sieve for Top-Down® bucket

REF.	NOTES	PCK	VOLUME (m³)	GROSS WEIGHT (kg)	SIZE (cm) ↓ ↓ ↓
P1190041U	for Top-Down® 8 L	9	-	1,52	33,3x14,2x2,2
P1190042U	for Top-Down® 10 and 20 L	10	0,031	4,24	54x20x3



Ideal for a uniform distribution of the cleaning solution - For a quick pre-soaking (max 15 minutes)



MOP SOAKING ON DEMAND AND PRE-SOAKING SYSTEM

Plastic sliding drawer without locking key



REF.	NOTES	CAPACITY (L)	PCK	VOLUME (m³)	GROSS WEIGHT (kg)	SIZE (cm) ↓ ↓ ↓
P1229909U	internal dimensions 41x34x9,5 cm	10	14	0,181	13,79	46,5x37,5x11
P1229906U	internal dimensions 40,5x34x16 cm	22	12	0,181	16,3	46,5x37,5x17

Pierced plastic sieve for mop soaking fitting drawers 10, 22 and 40 L

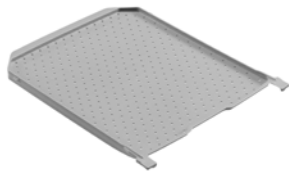

REF.	NOTES	PCK	VOLUME (m³)	GROSS WEIGHT (kg)
P1909925U		10	0,038	5,69

Ideal for a uniform distribution of the cleaning solution - For a quick pre-soaking (max 15 minutes)

Pierced plastic sieve with high border for mop soaking fitting drawers 10, 22 and 40 L

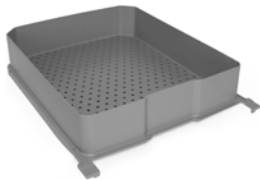

REF.	NOTES
P1909961U	

Ideal for a uniform distribution of the cleaning solution - For a quick pre-soaking (max 15 minutes)

Plastic cover for drawers 10, 22 and 40 L



REF.	NOTES	PCK	VOLUME (m³)	GROSS WEIGHT (kg)
P1909933U		10	0,038	7,21

Graduated plastic jar



REF.	NOTES	PCK	VOLUME (m³)	GROSS WEIGHT (kg)
P191000T	3L	12	0,073	2,96
P192000T	0,5L	80	0,079	3,84

MOP SOAKING ON DEMAND AND PRE-SOAKING SYSTEM

Click Safe System

Plastic bucket 20 L with plastic handle



REF.	NOTES	PCK	VOLUME (m³)	GROSS WEIGHT (kg)	SIZE (cm) ↓ ↓ ↓
0000SE1222A		10	0,169	12,6	24x55x27
0000SE1222B		10	0,169	12,6	24x55x27
0000SE1222U		10	0,169	12,6	24x55x27



Plastic lid for Click Safe system

NEW



REF.	NOTES	PCK	VOLUME (m³)	GROSS WEIGHT (kg)	SIZE (cm) ↓ ↓ ↓
P190360U		10	0,056	3,4	55x23x12



Rilsan coated bucket holder for 10/20 liter buckets, to be applied at the base of Alpha trolleys

NEW



REF.	NOTES	PCK	GROSS WEIGHT (kg)
R2200045		1	2,3



Mesh bag with closing string

NEW



REF.	NOTES	CAPACITY (L)	PCK	GROSS WEIGHT (kg)	SIZE (cm) ↓ ↓ ↓
0000AT0214B	stabilized polyester	35	1	0	65x46





MOP SOAKING ON DEMAND AND PRE-SOAKING SYSTEM

Trolley for the buckets transport

POCKET - foldable metal trolley for Top-Down® buckets 10 and 20 L



REF.	NOTES	PCK	VOLUME (m³)	GROSS WEIGHT (kg)
V2030122		10	0,07	14



Rilsan coated trolley for Top-Down® buckets 10 and 20 L, with wheels ø 170 mm



REF.	NOTES	PCK	VOLUME (m³)	GROSS WEIGHT (kg)
R2030120		2	0,21	8,06



Fitting Morgan trolleys art.no. 0000MP8010A and 0000MP8020A

Rilsan coated trolley kit with wheels ø 200 mm with trolley locking device and fixing hooks, for Top-Down® buckets 10 and 20 L



REF.	NOTES	PCK	VOLUME (m³)	GROSS WEIGHT (kg)	SIZE (cm)
R3030162		2	0,21	11,06	32x60x94



Fitting Alpha trolleys - Recommended with supporting plate cod. P065060U



SEE MOPS/CLOTHS RANGE AND RELATED MOP HOLDERS IN THE FLOOR CLEANING LINE



Glass and surface cleaning line

- Window washers
- Window squeegees
- Telescopic poles
- Brilliant system
- Equipment for glass cleaning
- Hand dusters
- Manual cloths
- Mono-Roll system
- Top-Clean system

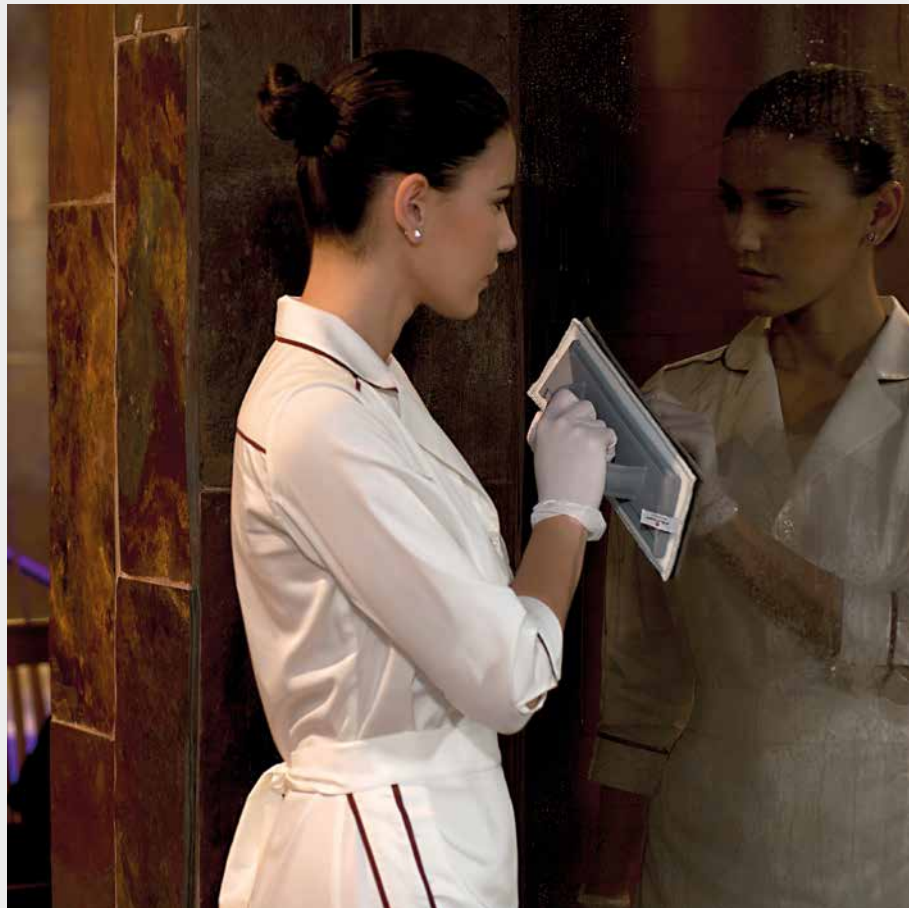



WINDOW WASHERS

WINDOW SQUEEGEES

TELESCOPIC POLES

BRILLIANT SYSTEM

EQUIPMENT FOR GLASS CLEANING

HAND DUSTERS

MANUAL CLOTHS

MONO-ROLL SYSTEM

TOP-CLEAN SYSTEM

Window washers and replacements

Window washer with fixed plastic support



REF.	NOTES	PCK	VOLUME (m³)	GROSS WEIGHT (kg)	SIZE (cm) ↓ ↓ ↓
9101		12	0,025	1,89	25
9102		12	0,033	2,41	35
9103		12	0,041	2,7	45
9104		12	0,04	3	55

Long yarn window washer with fixed plastic support



REF.	NOTES	PCK	VOLUME (m³)	GROSS WEIGHT (kg)	SIZE (cm) ↓ ↓ ↓
9501		12	0,025	1,89	25
9502		12	0,033	2,38	35
9503		12	0,041	2,7	45
9504		12	0,04	3	55

Window washer with pad, fixed plastic support



REF.	NOTES	PCK	VOLUME (m³)	GROSS WEIGHT (kg)	SIZE (cm) ↓ ↓ ↓
9131		12	0,025	1,79	25
9132		12	0,033	2,55	35
9133		12	0,041	3,06	45
9134		12	0,043	3,38	55

Long yarn window washer with abrasive fiber and fixed plastic support



REF.	NOTES	PCK	VOLUME (m³)	GROSS WEIGHT (kg)	SIZE (cm) ↓ ↓ ↓
9531		12	0,025	1,79	25
9532		12	0,033	2,55	35
9533		12	0,041	3,06	45
9534		12	0,043	3,38	55

Striped window washer with long yarn complete with fixed plastic support



REF.	NOTES	PCK	VOLUME (m³)	GROSS WEIGHT (kg)	SIZE (cm) ↓ ↓ ↓
9301		12	0,02	2,11	25
9302		12	0,033	2,38	35
9303		12	0,041	2,7	45

Striped window washer with long yarn and abrasive pad, complete with fixed plastic support



REF.	NOTES	PCK	VOLUME (m³)	GROSS WEIGHT (kg)	SIZE (cm) ↓ ↓ ↓
9331		12	0,02	2,11	25
9332		12	0,033	2,38	35
9333		12	0,041	2,7	45

Polypropylene fixed support for window washer



REF.	NOTES	PCK	VOLUME (m³)	GROSS WEIGHT (kg)	SIZE (cm) ↓ ↓ ↓
9141		25	0,025	2,55	25
9142		25	0,033	3,06	35
9143		25	0,041	3,84	45
9144		25	0,043	4,13	55



- WINDOW WASHERS
- WINDOW SQUEEGEES
- TELESCOPIC POLES
- BRILLIANT SYSTEM
- EQUIPMENT FOR GLASS CLEANING
- HAND DUSTERS
- MANUAL CLOTHS
- MONO-ROLL SYSTEM
- TOP-CLEAN SYSTEM

Aluminium jointed support for window washer



REF.	NOTES	PCK	VOLUME (m³)	GROSS WEIGHT (kg)	SIZE (cm) ↓ ↓ ↓
9161		25	0,025	3,15	25
9162		25	0,033	3,96	35
9163		25	0,041	4,29	45

Polyester window washer replacement



REF.	NOTES	PCK	VOLUME (m³)	GROSS WEIGHT (kg)	SIZE (cm) ↓ ↓ ↓
9105		25	0,018	1,32	25
9106		25	0,024	1,63	35
9107		25	0,03	1,94	45
9108		25	0,043	2,58	55

Polyester long yarn window washer replacement



REF.	NOTES	PCK	VOLUME (m³)	GROSS WEIGHT (kg)	SIZE (cm) ↓ ↓ ↓
9505		25	0,018	1,32	25
9506		25	0,024	1,63	35
9507		25	0,03	1,94	45
9508		25	0,043	2,58	55

Polyester window washer replacement with pad



REF.	NOTES	PCK	VOLUME (m³)	GROSS WEIGHT (kg)	SIZE (cm) ↓ ↓ ↓
9135		25	0,018	1,57	25
9136		25	0,024	1,88	35
9137		25	0,03	2,19	45
9138		25	0,043	3,13	55

Polyester long yarn window washer replacement with abrasive fiber



REF.	NOTES	PCK	VOLUME (m³)	GROSS WEIGHT (kg)	SIZE (cm) ↓ ↓ ↓
9535		25	0,018	1,57	25
9536		25	0,024	1,88	35
9537		25	0,03	2,19	45
9538		25	0,043	3,13	55

Striped window washer replacement with long yarn, polyamide and acrylic



REF.	NOTES	PCK	VOLUME (m³)	GROSS WEIGHT (kg)	SIZE (cm) ↓ ↓ ↓
9305		25	0,02	1,35	25
9306		25	0,024	1,63	35
9307		25	0,03	1,94	45
9308		25	0,03	2,3	55

Striped window washer replacement with long yarn, polyamide and acrylic, with abrasive pad



REF.	NOTES	PCK	VOLUME (m³)	GROSS WEIGHT (kg)	SIZE (cm) ↓ ↓ ↓
9335		25	0,02	1,35	25
9336		25	0,02	1,67	35
9337		25	0,03	1,99	45



WINDOW WASHERS

WINDOW SQUEEGEES

TELESCOPIC POLES

BRILLIANT SYSTEM

EQUIPMENT FOR GLASS CLEANING

HAND DUSTERS

MANUAL CLOTHS

MONO-ROLL SYSTEM

TOP-CLEAN SYSTEM

NEW Gloss-W squeegee

Designed for professional window drying, the **Gloss-W** squeegee window excels in performance, convenience and hygiene while offering significant advantages:

- **Efficient:** the hard rubber allows the surface to be wiped perfectly in one wipe, ensuring significant time savings
- **Versatile:** plug-in handle allows use with telescopic poles, enabling work without ladders
- **Ergonomic:** designed to be user-friendly, either manually or in combination with the pole to safely reach higher areas
- **Hygienic:** made of stainless steel, completely rust-resistant, made of closed-cell rubber to prevent dirt and bacteria from getting in.



GLASS AND SURFACE CLEANING LINE

Window squeegees and replacements

GLOSS-W - Stainless steel window squeegee

NEW



REF.	NOTES	PCK	VOLUME (m³)	GROSS WEIGHT (kg)	SIZE (cm) ↓ ↓ ↓
9451		10	0,004	0	25
9452		10	0,004	0	35
9453		10	0,005	0	45
9454		10	0,005	0	55

Stainless steel grip for Gloss-W window squeegee

NEW



REF.	NOTES	PCK	GROSS WEIGHT (kg)
9661		10	0

Stainless steel channel with rubber blade for window squeegee

NEW



REF.	NOTES	PCK	GROSS WEIGHT (kg)	SIZE (cm) ↓ ↓ ↓
9363		25	0	25
9364		25	0	35
9365		25	0	45
9366		25	0	55



WINDOW WASHERS

WINDOW SQUEEGEES

TELESCOPIC POLES

BRILLIANT SYSTEM

EQUIPMENT FOR GLASS CLEANING

HAND DUSTERS

MANUAL CLOTHS

MONO-ROLL SYSTEM

TOP-CLEAN SYSTEM

Rubber blade for window squeegee

NEW



REF.	NOTES	PCK	VOLUME (m³)	GROSS WEIGHT (kg)	SIZE (cm) ↓ ↓ ↓
9271		10	0,001	0,65	92
9272		10	0,001	0,49	71
9376		25	0,002	0,83	55
9375		25	0,002	0,68	45
9374		25	0,002	0,5	35
9373		25	0,001	0,35	25

Jointed window squeegee support



REF.	NOTES	PCK	VOLUME (m³)	GROSS WEIGHT (kg)	SIZE (cm) ↓ ↓ ↓
9351		10	0,006	1,32	25
9352		10	0,033	2,26	35
9353		10	0,006	2,32	45
9354		10	0,006	2,92	55

Jointed grip for window squeegee



REF.	NOTES	PCK	VOLUME (m³)	GROSS WEIGHT (kg)
9461		10	0,006	1,02

Aluminium poles

Aluminum pole complete with cone with Italian thread



REF.	NOTES	PCK	VOLUME (m³)	GROSS WEIGHT (kg)	SIZE (cm) ↓ ↓ ↓
9080A	1 pc x 1,25 m	10	0,019	3,35	125
0000AS21150A	1 pc x 1,5 m	10	0,024	3,96	150

Aluminum telescopic pole complete with end cone with Italian thread – 2 pieces



REF.	NOTES	PCK	VOLUME (m³)	GROSS WEIGHT (kg)	SIZE (cm) ↓ ↓ ↓
9079A	2 pcs x 0,60 m	25	0,031	8,69	120
9081A	2 pcs x 1,25 m	10	0,033	6,67	250
9078A	2 pcs x 1,50 m	10	0,041	7,63	300
9082A	2 pcs x 2,00 m	10	0,053	9,49	400
9083A	2 pcs x 3,00 m	10	0,065	13,81	600
00059081A	2 pcs x 1,25 m	5	0,019	3,79	250
00059078A	2 pcs x 1,50 m	5	0,024	4,24	300
00059082A	2 pcs x 2,00 m	5	0,031	5,31	400
00059083A	2 pcs x 3,00 m	5	0,035	7,53	600



WINDOW WASHERS

WINDOW SQUEEGEES

TELESCOPIC POLES

BRILLIANT SYSTEM

EQUIPMENT FOR GLASS CLEANING

HAND DUSTERS

MANUAL CLOTHS

MONO-ROLL SYSTEM

TOP-CLEAN SYSTEM

Aluminum telescopic pole complete with end cone with Italian thread – 3 pieces



REF.	NOTES	PCK	VOLUME (m³)	GROSS WEIGHT (kg)	SIZE (cm) ↓ ↓ ↓
9086A	3 pcs x 1,00 m	10	0,03	8,69	300
9087A	3 pcs x 1,50 m	10	0,041	12,13	450
9084A	3 pcs x 2,00 m	10	0,053	15,41	600
9085A	3 pcs x 3,00 m	10	0,065	22,75	900
9090A	2 pcs x 4 m + 1 pc x 3 m	5	0,058	13	1100
00059086A	3 pcs x 1,00 m	5	0,019	4,68	300
00059087A	3 pcs x 1,50 m	5	0,024	6,42	450
00059084A	3 pcs x 2,00 m	5	0,031	8,15	600
00059085A	3 pcs x 3,00 m	5	0,035	12	900

Accessories for poles

Cranked joint for telescopic pole



REF.	NOTES
9088A	

End cone with Italian screw for telescopic pole



REF.	NOTES
9089/2A	

Hook for telescopic pole



REF.	NOTES
9096A	

Grey laquered wooden and metal display stand for handles and telescopic poles



REF.	NOTES	PCK	VOLUME (m³)	GROSS WEIGHT (kg)	SIZE (cm) ↓ ↓ ↓
P06000		1	0,01	5,03	45x45x41



WINDOW WASHERS

WINDOW SQUEEGEES

TELESCOPIC POLES

BRILLIANT SYSTEM

EQUIPMENT FOR GLASS CLEANING

HAND DUSTERS

MANUAL CLOTHS

MONO-ROLL SYSTEM

TOP-CLEAN SYSTEM

Brilliant window cleaning system is the ideal solution for the cleaning of vertical smooth surfaces like interior window cleaning, mirrors, stainless steel surfaces, lacquered surfaces, painted doors, etc.

- **Fast:** the light and handy mop holder and the ultra-microfiber mop combined with a specific alcoholic-based detergent for surfaces, guarantee shining surfaces with just one wipe
- **High performance:** thanks to its excellent features, the specific ultra-microfiber mop removes fingerprints, smears, dust particles and dirt with excellent cleaning results
- **Efficient:** the use of a flat mop holder guarantees a considerable working time reduction in comparison with traditional hand cleaning systems and a perfect adherence of the mop holder to the surface
- **Ergonomic:** a handy and ergonomic cleaning system both with mop holder with hand grip and with mop holder combined with telescopic handle to safely reach also the highest areas



■ Holders and cloths for Brilliant system

TOP-CLEAN - plastic mop holder with grip and strips 2,5 cm for strap tape system

REF.	NOTES	PCK	VOLUME (m³)	GROSS WEIGHT (kg)	SIZE (cm) ↓ ↓ ↓
5233U		10	0,016	2,28	30
5234U		10	0,019	2,9	40



Mop holder used with Brilliant system for cleaning interior glass, mirrors and all smooth vertical surfaces and with Top Clean system for cleaning tables in cafeterias, bars, kitchens, restaurants...

Mop holder with strips for strap tape system with Lock System



REF.	NOTES	PCK	VOLUME (m³)	GROSS WEIGHT (kg)	SIZE (cm) ↓ ↓ ↓
5388U		10	0,016	2,34	30x8
5389U		10	0,019	3,1	40x8



WINDOW WASHERS

WINDOW SQUEEGEES

TELESCOPIC POLES

BRILLIANT SYSTEM

EQUIPMENT FOR GLASS CLEANING

HAND DUSTERS

MANUAL CLOTHS

MONO-ROLL SYSTEM

TOP-CLEAN SYSTEM

Ultra-microfiber mop head with backing for strap tape system

REF.	NOTES	PCK	VOLUME (m ²)	GROSS WEIGHT (kg)	SIZE (cm) ↓ ↓ ↓
0000PN02016		25	0,007	0,99	30x11
0000PN03016		25	0,011	1,49	40x11

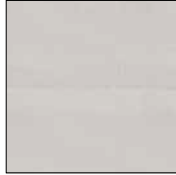

Ideal for stainless steel surfaces, mirrors and windows

MICRO-ACTIVA - ultra-microfiber mop, polyester backing, with strap tape system and colour-coded tag

REF.	NOTES	PCK	VOLUME (m ²)	GROSS WEIGHT (kg)	SIZE (cm) ↓ ↓ ↓
000EPN02012		25	0,011	1,32	30
000EPN03012		25	0,015	1,86	40
000EPN03022		25	0,03	2,77	60

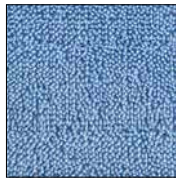
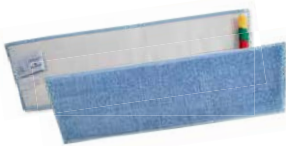

Ideal for industrial floors, single-fired tiles, stoneware and woods with a medium degree of dirt

Kit BRILLIANT



REF.	NOTES	PCK	VOLUME (m ²)	GROSS WEIGHT (kg)
0000SM00619		10	0,028	3,99
0000PN02016	Ultra-microfiber cloths with backing for strap tape system, 30 cm			5 pcs
5233U	TOP-CLEAN - plastic mop holder with grip and strips 2,5 cm for strap tape system			1 pc.

Standard cleaning kit for easily accessible shiny surfaces

Kit BRILLIANT PLUS



REF.	NOTES	PCK	VOLUME (m ²)	GROSS WEIGHT (kg)
0000SM00621	Italian / English	1	0,005	0,94
0000SM00632	French / German	1	0,005	0,94
0000AM3090A	Telescopic anodized aluminium handle 2 pcs with grey ergonomic grip, extension from 56 till 93 cm and blue cap			1 pc.
0000PN02016	Ultra-microfiber cloths with backing for strap tape system, 30 cm			2 pcs
000EPN02012	MICRO-ACTIVA - ultra-microfiber mop with strap tape system, with colour-coded tag, 30 cm			1 pc.
5233U	TOP-CLEAN - plastic mop holder with grip and strips 2,5 cm for strap tape system			1 pc.
5388U	Mop holder 30x8 cm for strap tape system with Lock System			1 pc.



Complete kit for the cleaning of shiny surfaces, easily reachable



WINDOW WASHERS

WINDOW SQUEEGEES

TELESCOPIC POLES

BRILLIANT SYSTEM

EQUIPMENT FOR GLASS CLEANING

HAND DUSTERS

MANUAL CLOTHS

MONO-ROLL SYSTEM

TOP-CLEAN SYSTEM

Accessories for Brilliant system

2-piece anodized aluminium telescopic handle with ergonomic grip and coloured cap



REF.	NOTES	PCK	VOLUME (m³)	GROSS WEIGHT (kg)	SIZE (cm) ↓ ↓ ↓	
0000AM3070A	blue, with blue cap		10	0,02	4,38	184
0000AM3070UU	grey, with grey cap		10	0,02	4,38	184
0000AM3070UA	grey, with blue cap		10	0,02	4,38	184
0000AM3070UB	grey, with red cap		10	0,02	4,38	184
0000AM3070UC	grey, with yellow cap		10	0,02	4,38	184
0000AM3070UF	grey, with green cap		10	0,02	4,38	184
0000AM3090A	blue, with blue cap		10	0,012	2,98	93

Art. 0000AM3070 extendable from 102 to 184 cm - Art. 0000AM3090A extendable from 56 to 93 cm - External tube ø 26 mm, internal tube ø 23 mm

Plastic carry basket complete with 3 dividers and grip



REF.	NOTES	SIZE (cm) ↓ ↓ ↓
3669U		32,5x25x31

Plastic carry basket with special shaped bottle holder, 2 compartments and fixed grip



REF.	NOTES	SIZE (cm) ↓ ↓ ↓
3690U		33,5x28,3x27



Spare strip for strap tape system plastic mop holders



REF.	NOTES
P191085U	for mop holder 30 cm long side (23,3 cm)
P191077U	for mop holder 30 cm short side (20 cm)
P191068U	for mop holder 40 cm long side (35,4 cm)
P191069U	for mop holder 40 cm short side (32 cm)
P191071U	for mop holder 60 cm long side (52,2 cm)
P191070U	for mop holder 60 cm short side (48,6 cm)

Round cloth star fixing clip



REF.	NOTES
60062U	



WINDOW WASHERS

WINDOW SQUEEGEES

TELESCOPIC POLES

BRILLIANT SYSTEM

EQUIPMENT FOR GLASS CLEANING

HAND DUSTERS

MANUAL CLOTHS

MONO-ROLL SYSTEM

TOP-CLEAN SYSTEM

Bucket for window cleaning

Plastic bucket 20 L with plastic handle



REF.	NOTES	PCK	VOLUME (m³)	GROSS WEIGHT (kg)	SIZE (cm) ↓ ↓ ↓
0000SE1222A		10	0,169	12,6	24x55x27
0000SE1222B		10	0,169	12,6	24x55x27
0000SE1222U		10	0,169	12,6	24x55x27



Plastic sieve fitting bucket trolley for wax application / window cleaning



REF.	NOTES	PCK	VOLUME (m³)	GROSS WEIGHT (kg)	SIZE (cm) ↓ ↓ ↓
9206A		30	0,1	7,35	8x53x10

For window washer 35 and 40 cm

Wheel ø 50 mm



REF.	NOTES
7949	For King, Spider, Ro-cket Wheels, Duo Pro System, Prisma, Twin, Top-Down®, Pick-Up, Trend and code 0000SE1428

Scrapers

CLIP - scraper with 10 blades



REF.	NOTES	PCK	VOLUME (m³)	GROSS WEIGHT (kg)	SIZE (cm) ↓ ↓ ↓
9216		25	0,004	1,95	10x2,4

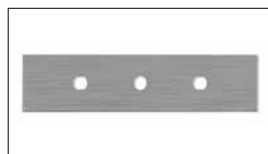

To be used only with handgrips code 9661

Blades for Clip scraper



REF.	NOTES	SIZE (cm) ↓ ↓ ↓
9217	1 pc art. 9217 = 100 blades	10x2x0,02

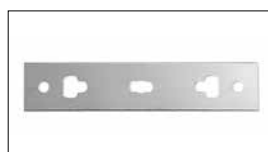



WINDOW WASHERS

WINDOW SQUEEGEES

TELESCOPIC POLES

BRILLIANT SYSTEM

EQUIPMENT FOR GLASS CLEANING

HAND DUSTERS

MANUAL CLOTHS

MONO-ROLL SYSTEM

TOP-CLEAN SYSTEM

Pocket scraper without blades



REF.	NOTES	PCK	VOLUME (m³)	GROSS WEIGHT (kg)	SIZE (cm) ↓ ↓ ↓
9091		50	0,003	2,34	9,5x4,5

Blades for pocket scraper



REF.	NOTES	SIZE (cm) ↓ ↓ ↓
9095	1 pc art. 9095 = 100 blades	4x2,5x0,023

Fixi clamp

FIXI - aluminium clamp for telescopic pole



REF.	NOTES	PCK	VOLUME (m³)	GROSS WEIGHT (kg)	SIZE (cm) ↓ ↓ ↓
9110		10	0,014	3,13	19,5x16x12

Sponge for Fixi clamp



REF.	NOTES	PCK	VOLUME (m³)	GROSS WEIGHT (kg)	SIZE (cm) ↓ ↓ ↓
9111		180	0,38	7,56	12x29x6,5

Brush for Fixi clamp



REF.	NOTES	PCK	VOLUME (m³)	GROSS WEIGHT (kg)	SIZE (cm) ↓ ↓ ↓
9112		10	0,013	2,8	23x6,4x7,3



WINDOW WASHERS

WINDOW SQUEEGEES

TELESCOPIC POLES

BRILLIANT SYSTEM

EQUIPMENT FOR GLASS CLEANING

HAND DUSTERS

MANUAL CLOTHS

MONO-ROLL SYSTEM

TOP-CLEAN SYSTEM

Window cleaning set

Window cleaning set



REF.	NOTES	PCK	VOLUME (m³)	GROSS WEIGHT (kg)
9120		1	0,049	4,38
0000AS23050	Telescopic pole 3 pcs X 0,50 m			1 pc.
9088A	Cranked joint for telescopic pole			1 pc.
9102	Window washer with fixed plastic support 35 cm			1 pc.
9111	Sponge for Fixi clamp			1 pc.
9214	Cobweb brush with Italian thread			1 pc.
9216	CLIP - scraper with 10 blades			1 pc.
9271	Rubber blade for window squeegee 92 cm, Filmop line			1 pc.
9363	Stainless steel channel with rubber blade for window squeegee 25 cm, Filmop line			1 pc.
9364	Stainless steel channel with rubber blade for window squeegee 35 cm, Filmop line			1 pc.
9365	Stainless steel channel with rubber blade for window squeegee 45 cm, Filmop line			1 pc.
9661	Stainless steel grip for window squeegee, Filmop line			1 pc.
9851	Floor scraper with plastic grip			1 pc.
TCH101240	SILKY-T - green microfiber cloth, 30x40 cm			1 pc.

Cobweb brushes

Cobweb brush



REF.	NOTES	PCK	VOLUME (m³)	GROSS WEIGHT (kg)
9214	with Italian screw	12	0,072	1,93
9314	with American screw	12	0,072	2

The version with Italian thread is suitable for telescopic handles and aluminum handles with 3 holes with the addition of the cone cod. P179040A

C-shaped cobweb brush



REF.	NOTES	PCK	VOLUME (m³)	GROSS WEIGHT (kg)
9215	with Italian screw	12	0,035	1,91
9315	with American screw	12	0,035	1,98

The version with Italian thread is suitable for telescopic handles and aluminum handles with 3 holes with the addition of the cone cod. P179040A

GLASS AND SURFACE CLEANING LINE



WINDOW WASHERS

WINDOW SQUEEGEES

TELESCOPIC POLES

BRILLIANT SYSTEM

EQUIPMENT FOR GLASS CLEANING

HAND DUSTERS

MANUAL CLOTHS

MONO-ROLL SYSTEM

TOP-CLEAN SYSTEM

Flatty: the hand duster that makes cleaning easier

The innovating **Flatty** hand duster is ideal to clean all surfaces thanks to its ultra flexibility.

- **Designed to be used with multipurpose cloths** for the cleaning of surfaces, till now used only by hand.
- **The cloths are rolled up on the hand duster support** and can be fixed thanks to the specific fixing clips.
- **The width of the hand duster** allows a quick and efficient dusting operation in a few simple steps.

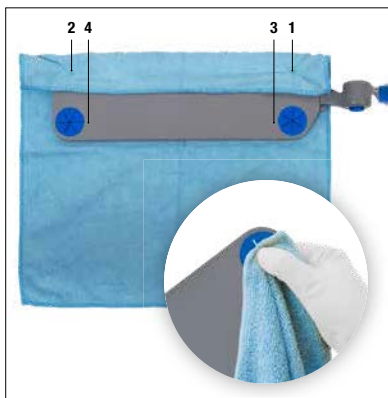

Wrap the cloth and fix it thanks to the **four clips**

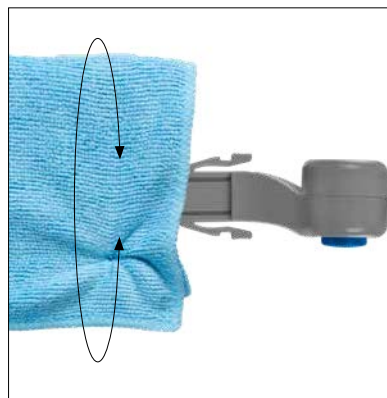

Turn 360° to clean a bigger surface

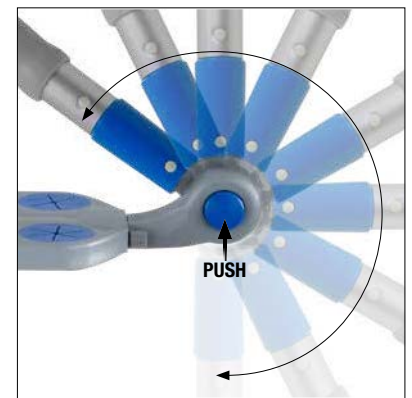

Push the button and **bend to 270°** to clean even the hard-to-reach areas

SNAKE: shapeable hand duster

Designed with a much more flexible and stronger plastic support, Snake can be used on both irregular and rounded surfaces for high-quality and more effective performances.

The hand duster is available also in the version equipped with **cloth fixing star-clips** to fix the disposable cloths and with a **practical push button** in the joint that allows to bend the hand duster support very quickly.

Shapeable to clean both irregular and rounded surfaces



270° rotating joint



WINDOW WASHERS

WINDOW SQUEEGEES

TELESCOPIC POLES

BRILLIANT SYSTEM

EQUIPMENT FOR GLASS CLEANING

HAND DUSTERS

MANUAL CLOTHS

MONO-ROLL SYSTEM

TOP-CLEAN SYSTEM

Spillo-Snake hand dusters

Shapable rubber mop holder with cloth fixing clips and grip with Italian thread for **SNAKE** hand duster

REF.	NOTES	PCK	VOLUME (m ³)	GROSS WEIGHT (kg)	SIZE (cm) ↓ ↓ ↓
2440U		6	0,006	1,59	40
2640U		6	0,011	2,18	60

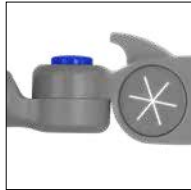

Fitting telescopic handles and aluminium handles with 3 holes by means of the end cone adaptor ref. P179040A - Suitable for use with QUIK-STIK disposable cloths

Plastic mop holder with grip with Italian thread for **SPILLO** hand duster

REF.	NOTES	PCK	VOLUME (m ³)	GROSS WEIGHT (kg)	SIZE (cm) ↓ ↓ ↓
2460U		6	0,008	1,31	40
2660U		6	0,011	1,57	60



Fitting telescopic handles and aluminium handles with 3 holes by means of the end cone adaptor ref. P179040A - Suitable for use with QUIK-STIK disposable cloths

Acrylic sleeve for hand dusters **SPILLO** and **SNAKE**

REF.	NOTES	PCK	VOLUME (m ³)	GROSS WEIGHT (kg)	SIZE (cm) ↓ ↓ ↓
1084A		12	0,011	1,32	40
2084A		12	0,015	1,75	60



Microfiber sleeve for **SPILLO** and **SNAKE** hand dusters, 1 side long yarn_1 side short yarn

REF.	NOTES	PCK	VOLUME (m ³)	GROSS WEIGHT (kg)	SIZE (cm) ↓ ↓ ↓
1086		12	0,011	1,27	40
2086		12	0,015	1,71	60



Microfiber short sleeve for hand dusters **SPILLO** e **SNAKE**

REF.	NOTES	PCK	VOLUME (m ³)	GROSS WEIGHT (kg)	SIZE (cm) ↓ ↓ ↓	
1085		<input type="checkbox"/>	12	0,011	1,27	40
1085A		<input checked="" type="checkbox"/>	12	0,011	0,6	40
2085		<input type="checkbox"/>	12	0,015	1,69	60
2085A		<input checked="" type="checkbox"/>	12	0,015	0,74	60





WINDOW WASHERS

WINDOW SQUEEGEES

TELESCOPIC POLES

BRILLIANT SYSTEM

EQUIPMENT FOR GLASS CLEANING

HAND DUSTERS

MANUAL CLOTHS

MONO-ROLL SYSTEM

TOP-CLEAN SYSTEM

QUIK-STIK - Disposable cloth with glue for Spillo and Snake hand dusters

REF.	NOTES	PCK	VOLUME (m ²)	GROSS WEIGHT (kg)	SIZE (cm) ↓ ↓ ↓
00PU0102000	Pkg: 20 polybags with 12 pcs each	1	0,034	2,26	40
00PU0102001	Pkg: 20 polybags with 12 pcs each	1	0,045	3,38	60

Code 00PU0102000 available while supplies last

Flatty hand duster

FLATTY - plastic mop holder with grip with Italian thread for dusting with microfiber mops

REF.	NOTES	PCK	VOLUME (m ²)	GROSS WEIGHT (kg)	SIZE (cm) ↓ ↓ ↓
2430U		10	0,03	3,52	11x54



Fitting telescopic handles and aluminium handles with 3 holes by means of the end cone adaptor ref. P1 79040A - Suitable for 40x40 cm microfibre dust cloths (see the Touch cloth section)

FLATTY - plastic hand duster for microfiber cloths

REF.	NOTES	PCK	VOLUME (m ²)	GROSS WEIGHT (kg)	SIZE (cm) ↓ ↓ ↓
1430		10	0,03	3,56	11x54



Adaptable to telescopic poles and aluminium handles - Suitable for 40x40 cm microfibre dust cloths (see the Touch cloth section)

Available while stocks last

QUIK-STIK - Disposable cloth with glue for Flatty holder

REF.	NOTES	PCK	VOLUME (m ²)	GROSS WEIGHT (kg)	SIZE (cm) ↓ ↓ ↓
00PU0102002	Pck: 10 polybags with 25 pcs each	1	0,038	2,73	31x38



Available while stocks last

Fil hand duster

FIL - acrylic hand duster in polybag

REF.	NOTES	PCK	VOLUME (m ²)	GROSS WEIGHT (kg)
2012		50	0,079	6,48





WINDOW WASHERS

WINDOW SQUEEGEES

TELESCOPIC POLES

BRILLIANT SYSTEM

EQUIPMENT FOR GLASS CLEANING

HAND DUSTERS

MANUAL CLOTHS

MONO-ROLL SYSTEM

TOP-CLEAN SYSTEM

Daster: foldable hand duster

Daster is a hand duster designed to overcome any limit:

- Its forked part allows to **clean even the most difficult to reach surfaces**
- Its practical push-button allows to **bend the hand duster up to 240°** in order to adapt it to the surface to clean
- The mop fixing system allows to **secure the mop**
- Suitable for telescopic handles and poles to **reach also the highest areas**



240°



Equipped with a **100% acrylic spare mop**, it traps and keeps effectively even the smallest particle of dust.

Daster hand duster

DASTER - acrylic hand duster with grip with Italian thread, single packed

REF.	NOTES	PCK	VOLUME (m³)	GROSS WEIGHT (kg)
2013		6	0,022	1,8



Fitting telescopic handles and aluminium handles with 3 holes by means of the end cone adaptor ref. P179040A - Ideal packaging for resale

Acrylic mop for hand duster **DASTER**



REF.	NOTES	PCK	VOLUME (m³)	GROSS WEIGHT (kg)
1090		12	0,011	0,89



WINDOW
WASHERS

WINDOW
SQUEEGEES

TELESCOPIC
POLES

BRILLIANT
SYSTEM

EQUIPMENT FOR
GLASS CLEANING

HAND DUSTERS

MANUAL CLOTHS

MONO-ROLL
SYSTEM

TOP-CLEAN
SYSTEM

Accessories hand dusters

End cone with Italian thread for telescopic handles and 3-hole aluminum handles ø 23 mm



REF.	NOTES
P179040A	

Set 6 pcs adapter with American thread for hand dusters and cobweb brushes



REF.	NOTES
0000SM00038U	



WINDOW WASHERS

WINDOW SQUEEGEES

TELESCOPIC POLES

BRILLIANT SYSTEM

EQUIPMENT FOR GLASS CLEANING

HAND DUSTERS

MANUAL CLOTHS

MONO-ROLL SYSTEM

TOP-CLEAN SYSTEM

Each surface has specific qualities and features that could be irreparably damaged, if cleaned with unsuitable cloths. This is the reason why Filmop has designed and carried out its **TOUCH** line of cloths and sponges: top quality products for the cleaning of environments, from the floor to the most delicate surfaces, that ensure the best results in the shortest time and with the minimum effort. **TOUCH** products are divided according to their cleaning features, differing between **Multipurpose** and **Specials**. The special range includes **EU Ecolabel certified cloths**, a guarantee of sustainability throughout the entire life cycle.

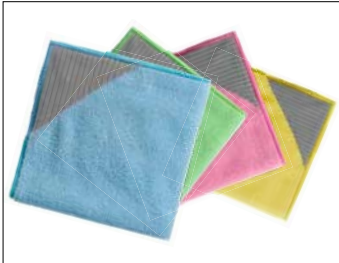

Multipurpose

Cloths to use dry for a quick and daily cleaning; if dampened with water or detergents, they are advised for a deeper and more professional dusting.



Specials

Cloths meant for specific cleaning operations, they clean effectively without leaving marks and help the quick drying of surfaces if used wet.

Washing temperatures:

90°: Multi-T, Multi-T Maxi, Multi-T Light, Dual-T, Silky-T, Multi-T antibatterico, Steel-T, Power-T, Glazy-T, Eco Multi-T

60°: Free-T, Slide-T, Cristal-T, Glass-T, Basic-T, Fast-T, Profi-T

COLOR CODE

The colour of cloths represents a shared colour-coding that identifies the area to be cleaned and how to be used, avoiding the transmission of dirt and bacteria from one cleaned surface to another one, reducing any risk of cross-contamination.



Red cloth: very high risk
For the cleaning of bidets, WC



Yellow cloth: high risk
Cleaning of washbasins, tiles and mirrors in bathrooms



Green cloth: medium risk
Cleaning in kitchens, canteens and bars



Blue cloth: low risk
For the cleaning of all surfaces, such as tables, writing desks, wardrobes, glasses

Power-T: multipurpose cloths, ideal for any surface

The Power-T cloth quickly cleans **any kind of surface**: made of non woven ultra-microfiber, **exerts a degreasing and polishing action**.

Resistant and long lasting, ideal for **dry** and **wet dust mopping**.



Glazy-T: special cloth for glass and windows

The Glazy-T cloth is the ideal solution for **glass** and **windows**: made of non woven ultra-microfiber, **it ensures an effective cleaning and leaves no streaks**.

It offers high performances both in **wet** and **dry** use and **excellent resistance to washing**.



- BRIGHT CLEAN
- HIGH ABSORBENCY
- BEST SLIDING
- LONG LASTING PERFORMANCE





WINDOW WASHERS

WINDOW SQUEEGEES

TELESCOPIC POLES

BRILLIANT SYSTEM

EQUIPMENT FOR GLASS CLEANING

HAND DUSTERS

MANUAL CLOTHS

MONO-ROLL SYSTEM

TOP-CLEAN SYSTEM

Multipurpose cloths

POWER-T - non-woven ultra-microfiber cloth



REF.	NOTES		NET WEIGHT (kg)	PCK	VOLUME (m³)	GROSS WEIGHT (kg)	SIZE (cm) ↓ ↓ ↓
TCH201010			0,022	5	-	0,11	40x40
TCH201020			0,022	5	-	0,11	40x40
TCH201030			0,022	5	-	0,11	40x40
TCH201040			0,022	5	-	0,11	40x40
TCH201019	pck.: 20 polybags with 5 pcs		2,2	1	0,013	2,45	40x40
TCH201029	pck.: 20 polybags with 5 pcs		2,2	1	0,013	2,45	40x40
TCH201039	pck.: 20 polybags with 5 pcs		2,2	1	0,013	2,45	40x40
TCH201049	pck.: 20 polybags with 5 pcs		2,2	1	0,013	2,45	40x40

Cloth for all surfaces - Degreasing and polishing effect - Weight 130 gr/sqm

DUAL-T - ultra-microfiber multipurpose cloth with scrubbing edge



REF.	NOTES		NET WEIGHT (kg)	PCK	VOLUME (m³)	GROSS WEIGHT (kg)	SIZE (cm) ↓ ↓ ↓
TCH104010			0,04	5	0,002	0,2	40x40
TCH104020			0,04	5	0,002	0,2	40x40
TCH104030			0,04	5	0,002	0,2	40x40
TCH104040			0,04	5	0,002	0,2	40x40
TCH104019	pck.: 40 polybags with 5 pcs		8,03	1	0,08	9,2	40x40
TCH104029	pck.: 40 polybags with 5 pcs		8,03	1	0,08	9,2	40x40
TCH104039	pck.: 40 polybags with 5 pcs		8,03	1	0,08	9,2	40x40
TCH104049	pck.: 40 polybags with 5 pcs		8,03	1	0,08	9,2	40x40



Cloth for any surface and for very dirty environments - Ideal to remove any marks and sediment deposit - Weight 250 gr/mq

ECO MULTI-T - multipurpose ultra-microfibre cloth

NEW

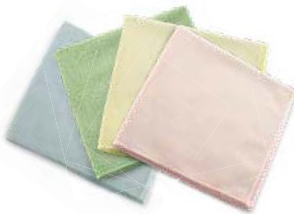

REF.	NOTES		NET WEIGHT (kg)	PCK	VOLUME (m³)	GROSS WEIGHT (kg)	SIZE (cm) ↓ ↓ ↓
TCE101010			0,042	5	0,002	0,21	40x40
TCE101020			0,042	5	0,002	0,21	40x40
TCE101030			0,042	5	0,002	0,21	40x40
TCE101040			0,042	5	0,002	0,21	40x40
TCE101019	pck.: 40 polybags with 5 pcs		8,44	1	0,08	8,85	40x40
TCE101029	pck.: 40 polybags with 5 pcs		8,4	1	0,08	8,81	40x40
TCE101039	pck.: 40 polybags with 5 pcs		8,44	1	0,08	8,85	40x40
TCE101049	pck.: 40 polybags with 5 pcs		8,44	1	0,08	8,85	40x40

Cloth for any surface and for very dirty environments - Resistant, it removes and keeps dirt - Weight 250 gr/sqm



WINDOW
WASHERS

WINDOW
SQUEEGEES

TELESCOPIC
POLES

BRILLIANT
SYSTEM

EQUIPMENT FOR
GLASS CLEANING

HAND DUSTERS

**MANUAL
CLOTHS**

MONO-ROLL
SYSTEM

TOP-CLEAN
SYSTEM

MULTI-T - ultra-microfiber multipurpose cloth



REF.	NOTES	NET WEIGHT (kg)	PCK	VOLUME (m³)	GROSS WEIGHT (kg)	SIZE (cm)
TCH101010		0,042	5	0,002	0,21	40x40
TCH101020		0,042	5	0,002	0,21	40x40
TCH101030		0,042	5	0,002	0,21	40x40
TCH101040		0,042	5	0,002	0,21	40x40
TCH101019	pck.: 40 polybags with 5 pcs	8,44	1	0,08	8,85	40x40
TCH101029	pck.: 40 polybags with 5 pcs	8,4	1	0,08	8,81	40x40
TCH101039	pck.: 40 polybags with 5 pcs	8,44	1	0,08	8,85	40x40
TCH101049	pck.: 40 polybags with 5 pcs	8,44	1	0,08	8,85	40x40

Cloth for any surface and for very dirty environments - Resistant, it removes and keeps dirt - Weight 250 gr/sqm

MULTI-T LIGHT - ultra-microfiber multipurpose cloth



REF.	NOTES	NET WEIGHT (kg)	PCK	VOLUME (m³)	GROSS WEIGHT (kg)	SIZE (cm)
TCH101510		0,03	20	0,007	0,6	38x38
TCH101520		0,03	20	0,007	0,6	38x38
TCH101530		0,03	20	0,007	0,6	38x38
TCH101540		0,03	20	0,007	0,6	38x38
TCH101519	pck.: 10 polybags with 20 pcs	6,064	1	0,047	6,6	38x38
TCH101529	pck.: 10 polybags with 20 pcs	6,064	1	0,047	6,6	38x38
TCH101539	pck.: 10 polybags with 20 pcs	6,064	1	0,047	6,6	38x38
TCH101549	pck.: 10 polybags with 20 pcs	6,064	1	0,047	6,6	38x38

Cloth for any surface and for very dirty environments - Resistant, it removes and keeps dirt - Weight 220 gr/sqm

MULTI-T A-B PLUS - anti-bacterial ultra-microfiber multipurpose cloth



REF.	NOTES	NET WEIGHT (kg)	PCK	VOLUME (m³)	GROSS WEIGHT (kg)	SIZE (cm)
TCH101410		0,056	5	0,002	0,28	40x40
TCH101420		0,056	5	0,002	0,28	40x40
TCH101430		0,056	5	0,002	0,28	40x40
TCH101440		0,056	5	0,002	0,28	40x40
TCH101419	pck.: 40 polybags with 5 pcs	11,2	1	0,08	11,6	40x40
TCH101429	pck.: 40 polybags with 5 pcs	11,2	1	0,08	11,6	40x40
TCH101439	pck.: 40 polybags with 5 pcs	11,2	1	0,08	11,6	40x40
TCH101449	pck.: 40 polybags with 5 pcs	11,2	1	0,08	11,6	40x40

With anti-bacterial treatment, it removes up to 99,98% of bacteria and fungi - Cloth for any surface and for very dirty environments - Resistant, it removes and keeps dirt - Weight 310 gr/mq

SILKY-T - ultra-microfiber multipurpose cloth



REF.	NOTES	NET WEIGHT (kg)	PCK	VOLUME (m³)	GROSS WEIGHT (kg)	SIZE (cm)
TCH101210		0,024	5	0,001	0,12	30x40
TCH101220		0,024	5	0,001	0,12	30x40
TCH101230		0,024	5	0,001	0,12	30x40
TCH101240		0,024	5	0,001	0,12	30x40
TCH101219	pck.: 48 polybags with 5 pcs	5,76	1	0,068	6,01	30x40
TCH101229	pck.: 48 polybags with 5 pcs	5,76	1	0,068	6,01	30x40
TCH101239	pck.: 48 polybags with 5 pcs	5,76	1	0,068	6,01	30x40
TCH101249	pck.: 48 polybags with 5 pcs	5,76	1	0,068	6,01	30x40

Cloth for all surfaces - Resistant, it removes and keeps dirt, lint and smear free - Weight 190 gr/mq



WINDOW WASHERS

WINDOW SQUEEGEES

TELESCOPIC POLES

BRILLIANT SYSTEM

EQUIPMENT FOR GLASS CLEANING

HAND DUSTERS

MANUAL CLOTHS

MONO-ROLL SYSTEM

TOP-CLEAN SYSTEM

FREE-T - Thermobounded non-woven multipurposes cloth



REF.	NOTES	NET WEIGHT (kg)	PCK	VOLUME (m³)	GROSS WEIGHT (kg)	SIZE (cm)
TCH601010		0,022	10	0,002	0,22	38x40
TCH601020		0,022	10	0,002	0,22	38x40
TCH601030		0,022	10	0,002	0,22	38x40
TCH601040		0,022	10	0,002	0,22	38x40
TCH601019	pck.: 20 polybags with 10 pcs	4,4	1	0,042	4,75	38x40
TCH601029	pck.: 20 polybags with 10 pcs	4,4	1	0,042	4,75	38x40
TCH601039	pck.: 20 polybags with 10 pcs	4,4	1	0,042	4,75	38x40
TCH601049	pck.: 20 polybags with 10 pcs	4,4	1	0,042	4,75	38x40

Cloth ideal to dust any surface - Half-disposable, cheap Weight 130 gr/sqm

Special cloths

STEEL-T - coagulated textile wiping cloth



REF.	NOTES	NET WEIGHT (kg)	PCK	VOLUME (m³)	GROSS WEIGHT (kg)	SIZE (cm)
TCH401010		0,046	5	0,002	0,23	38x38
TCH401020		0,046	5	0,002	0,23	38x38
TCH401030		0,046	5	0,002	0,23	38x38
TCH401040		0,046	5	0,002	0,23	38x38
TCH401019	pck.: 20 polybags with 5 pcs	4,958	1	0,028	5,23	38x38
TCH401029	pck.: 20 polybags with 5 pcs	4,958	1	0,047	5,23	38x38
TCH401039	pck.: 20 polybags with 5 pcs	4,958	1	0,047	5,23	38x38
TCH401049	pck.: 20 polybags with 5 pcs	4,958	1	0,047	5,23	38x38

Cloth for glossy surfaces, chromed steel, ceramics - Polishes and removed limescale - Degreasing - Weight 285 gr/mq

GLAZY-T - non-woven ultra-microfiber cloth



REF.	NOTES	NET WEIGHT (kg)	PCK	VOLUME (m³)	GROSS WEIGHT (kg)	SIZE (cm)
TCH201120		0,028	5	0,001	0,15	40x50
TCH201129	pck.: 20 polybags with 5 pcs	2,8	1	0,028	3,3	40x50

Ideal for glass, windows and dishes - It cleans without leaving marks - Weight 130 gr/sqm

GLASS-T - ultra-microfiber wiping cloth

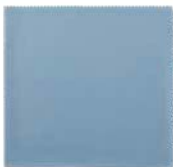

REF.	NOTES	NET WEIGHT (kg)	PCK	VOLUME (m³)	GROSS WEIGHT (kg)	SIZE (cm)
TCH103020		0,029	5	0,001	0,15	40x40
TCH103029	pck.: 40 polybags with 5 pcs	5,8	1	0,028	6	40x40

Cloth for glossy surfaces - It wipes without smearing - Ideal for glasses - Weight: 180 gr/Sq m



WINDOW
WASHERS

WINDOW
SQUEEGEES

TELESCOPIC
POLES

BRILLIANT
SYSTEM

EQUIPMENT FOR
GLASS CLEANING

HAND DUSTERS

**MANUAL
CLOTHS**

MONO-ROLL
SYSTEM

TOP-CLEAN
SYSTEM

CRISTAL-T - perforated wiping cloth



REF.	NOTES	NET WEIGHT (kg)	PCK	VOLUME (m³)	GROSS WEIGHT (kg)	SIZE (cm) ↓ ↓ ↓
TCH404030		0,031	10	0,002	0,31	38x40
TCH404039	pck.: 10 polybags with 10 pcs	3,15	1	0,028	3,35	38x40

Cloth for glossy surfaces - It wipes without smearing - Ideal for car cleaning - Weight: 180 gr/Sq m

SLIDE-T - resin coated wiping cloth



REF.	NOTES	NET WEIGHT (kg)	PCK	VOLUME (m³)	GROSS WEIGHT (kg)	SIZE (cm) ↓ ↓ ↓
TCH602030		0,024	10	0,002	0,24	40x45
TCH602039	pck.: 20 polybags with 10 pcs	4,8	1	0,064	5,43	40x45

Cloth ideal for any surface - Smooth-running and bleach resistant - Weight 160 gr/sqm

PROFI-T - non-woven ultra-microfiber cloth

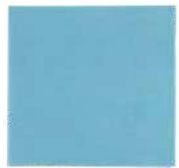

REF.	NOTES	NET WEIGHT (kg)	PCK	VOLUME (m³)	GROSS WEIGHT (kg)	SIZE (cm) ↓ ↓ ↓
TCH102020		0,02	5	0,001	0,1	38x40
TCH102029	pck.: 20 polybags with 5 pcs	2	1	0,01	2,35	38x40

Cloth for glass, glasses and delicate surfaces - Smooth-running and degreasing - Weight 100 gr/sqm

MULTI-T MAXI - ultra-microfiber multipurpose cloth



REF.	NOTES	NET WEIGHT (kg)	PCK	VOLUME (m³)	GROSS WEIGHT (kg)	SIZE (cm) ↓ ↓ ↓
TCH101120		0,08	5	0,004	0,4	50x60
TCH101129	pck.: 40 polybags with 5 pcs	16,08	1	0,079	16,38	50x60

Cloth for any surface and for very dirty environments - Resistant, soft and big size, it removes and keeps dirt - Weight 250 gr/sqm

BASIC-T - resin coated cloth for floor washing



REF.	NOTES	NET WEIGHT (kg)	PCK	VOLUME (m³)	GROSS WEIGHT (kg)	SIZE (cm) ↓ ↓ ↓
TCH603040		0,042	10	-	0,42	40x50
TCH603049	pck.: 20 polybags with 10 pcs	8,4	1	0,073	8,65	40x50

Cloth for smooth and delicate floors - Resistant and smooth-running - Weight 210 gr/sqm



WINDOW WASHERS

WINDOW SQUEEGEES

TELESCOPIC POLES

BRILLIANT SYSTEM

EQUIPMENT FOR GLASS CLEANING

HAND DUSTERS

MANUAL CLOTHS

MONO-ROLL SYSTEM

TOP-CLEAN SYSTEM

FAST-T- microfiber cloth for floor washing

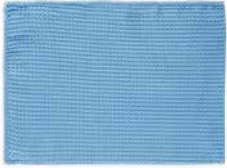

REF.	NOTES	NET WEIGHT (kg)	PCK	VOLUME (m³)	GROSS WEIGHT (kg)	SIZE (cm) ↓ ↓ ↓ ↓
TCH120020		0,061	5	0,002	0,31	60x40
TCH120029	pck.: 40 polybags with 5 pcs	12,2	1	0,087	12,55	60x40

Cloth for smooth and delicate floors - Resistant and smooth-running, it removes and keeps dirt - Weight 250 gr/sqm

INTENSIVE-T - sponge with ultra-abrasive scourer



REF.	NOTES	NET WEIGHT (kg)	PCK	VOLUME (m³)	GROSS WEIGHT (kg)	SIZE (cm) ↓ ↓ ↓ ↓
TCH803000		0,018	10	-	0,18	14x9,5x3,5
TCH803009	pck.: 10 polybags with 10 pcs	1,8	1	0,053	2,37	14x9,5x3,5

Sponge for any environment - Degreasing

Gloves

Ultra-microfiber mitten for dusting/washing, with color-coded tags



REF.	NOTES	PCK	VOLUME (m³)	GROSS WEIGHT (kg)	SIZE (cm) ↓ ↓ ↓ ↓
8593	Packed into polybags with 5 pcs each	5	0,001	0,17	14x26



Weight: 370 gr/mq

Ultra-microfiber mitten for glasses, with color-coded tags



REF.	NOTES	PCK	VOLUME (m³)	GROSS WEIGHT (kg)	SIZE (cm) ↓ ↓ ↓ ↓
8594	Packed into polybags with 5 pcs each	5	0,001	0,13	14x26



Weight: 300 gr/mq



WINDOW WASHERS

WINDOW SQUEEGEES

TELESCOPIC POLES

BRILLIANT SYSTEM

EQUIPMENT FOR GLASS CLEANING

HAND DUSTERS

MANUAL CLOTHS

MONO-ROLL SYSTEM

TOP-CLEAN SYSTEM

Mono-Roll disposable cloth

Mono-Roll is a **disposable TNT cloth with perforated weave** characterized by its high absorbency capacity and a uniform release of the cleaning solution on the surface.

- Removes and traps dirt
- Advised if used with disinfectants
- Excellent also for dry cleaning
- Manual use or combined with dusting mop holders for high surfaces



The roll can be soaked in a **plastic bucket 4L**, following a few simple steps.

- Hermetic lid with an exclusive and fast cloth extraction system
- Practical and handy, it can be used alone or with Alpha trolleys

Mono-Roll

MONO-ROLL - manual disposable cloth in TNT



REF.	NOTES	PCK	VOLUME (m ²)	GROSS WEIGHT (kg)	SIZE (cm) ↓ ↓ ↓
00PU0203000	pck.: 6 rolls with 90 tears each	1	0,025	2,76	32x28



4 lt plastic bucket with handle and hermetic cover with central slot for cloth extraction



REF.	NOTES	PCK	VOLUME (m ³)	GROSS WEIGHT (kg)	SIZE (cm) ↓ ↓ ↓
0000SE3104A		5	0,028	2,65	17x25,5x25
0000SE3104B		5	0,028	2,65	17x25,5x25
0000SE3104C		5	0,028	2,65	17x25,5x25
0000SE3104F		5	0,028	2,65	17x25,5x25





WINDOW WASHERS

WINDOW SQUEEGEES

TELESCOPIC POLES

BRILLIANT SYSTEM

EQUIPMENT FOR GLASS CLEANING

HAND DUSTERS

MANUAL CLOTHS

MONO-ROLL SYSTEM

TOP-CLEAN SYSTEM

Plastic mop holder with grip with Italian thread for **SPILLO** hand duster

REF.	NOTES	PCK	VOLUME (m³)	GROSS WEIGHT (kg)	SIZE (cm) ↓ ↓ ↓
2460U		6	0,008	1,31	40
2660U		6	0,011	1,57	60



Fitting telescopic handles and aluminium handles with 3 holes by means of the end cone adaptor ref. P179040A - Suitable for use with QUIK-STIK disposable cloths

Graduated plastic jar

REF.	NOTES	PCK	VOLUME (m³)	GROSS WEIGHT (kg)
P191000T	3L	12	0,073	2,96
P192000T	0,5L	80	0,079	3,84



Surface cleaning with pre-soaking system



Top-Clean is a cleaning system especially advised for the cleaning of desks, table-tops, tables, blackboards and walls in classrooms, schools, canteens, self-services, bars, restaurants and hotels.

This mop holder combined with a traditional mop covers a wider working area than the one covered by the operator's hand using a simple cloth, thus saving time during cleaning operations; it is ergonomic and handy thanks to its grip.



Top-Clean holder and mops

TOP-CLEAN - plastic mop holder with grip and strips 2,5 cm for strap tape system

REF.	NOTES	PCK	VOLUME (m³)	GROSS WEIGHT (kg)	SIZE (cm) ↓ ↓ ↓
5233U		10	0,016	2,28	30
5234U		10	0,019	2,9	40





WINDOW
WASHERS

WINDOW
SQUEEGEES

TELESCOPIC
POLES

BRILLIANT
SYSTEM

EQUIPMENT FOR
GLASS CLEANING

HAND DUSTERS

MANUAL CLOTHS

MONO-ROLL
SYSTEM

**TOP-CLEAN
SYSTEM**

RAPIDO SUPER EXTRA - high-performing white microfiber mop, looped yarn, with colored backing for strap tape system



REF.	NOTES	PCK	VOLUME (m³)	GROSS WEIGHT (kg)	SIZE (cm) ↓ ↓ ↓
00PN0323A00DA		25	0,011	1,69	30x10
00PN0423A00DA		25	0,015	2,44	40x10
00PN0423A00DB		25	0,015	2,44	40x10
00PN0423A00DC		25	0,015	2,44	40x10
00PN0423A00DF		25	0,015	2,44	40x10
00PN0623A00DA		20	0,015	2,67	60x10



Ideal for industrial floors, natural stones, single-fired tiles and stoneware with a medium-high degree of dirt

RAPIDO SUPER - high-performing white microfiber mop, looped yarn, with colored backing for strap tape system

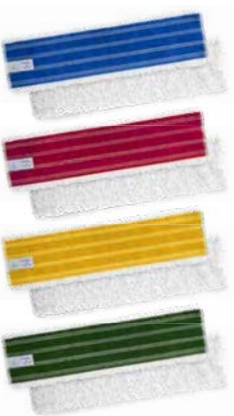

REF.	NOTES	PCK	VOLUME (m³)	GROSS WEIGHT (kg)	SIZE (cm) ↓ ↓ ↓
00PN0309A00DA		25	0,011	1,39	30x10
00PN0309A00DB		25	0,011	1,39	30x10
00PN0309A00DC		25	0,011	1,39	30x10
00PN0309A00DF		25	0,011	1,39	30x10
00PN0409A00DA		25	0,019	2,09	40x10
00PN0409A00DB		25	0,019	2,09	40x10
00PN0409A00DC		25	0,019	2,09	40x10
00PN0409A00DF		25	0,019	2,09	40x10
00PN0609A00DA		20	0,019	2,42	60x10
00PN0609A00DB		20	0,019	2,42	60x10
00PN0609A00DC		20	0,019	2,42	60x10
00PN0609A00DF		20	0,019	2,42	60x10



Ideal for any surface with medium-high dirt

RAPIDO - colored microfiber mop, looped yarn, with colored backing for strap tape system



REF.	NOTES	PCK	VOLUME (m³)	GROSS WEIGHT (kg)	SIZE (cm) ↓ ↓ ↓
0000214AA		25	0,015	2,44	40x10
0000214BB		25	0,015	2,44	40x10
0000214CC		25	0,015	2,44	40x10
0000214FF		25	0,015	2,44	40x10



Ideal for industrial floors, natural stones, single-fired tiles and stoneware with a medium-high degree of dirt



WINDOW
WASHERS

WINDOW
SQUEEGEES

TELESCOPIC
POLES

BRILLIANT
SYSTEM

EQUIPMENT FOR
GLASS CLEANING

HAND DUSTERS

MANUAL CLOTHS

MONO-ROLL
SYSTEM

**TOP-CLEAN
SYSTEM**

PULI-SCRUB - ultra-microfiber and polypropylene mop with strap tape system and colour-coded tag

REF.	NOTES	PCK	VOLUME (m ²)	GROSS WEIGHT (kg)	SIZE (cm) ↓ ↓ ↓
000EPN02011		25	0,011	1,49	30
000EPN03011		25	0,015	2,26	40
000EPN03021		25	0,03	3,32	60

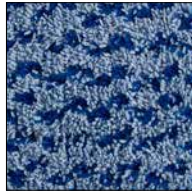
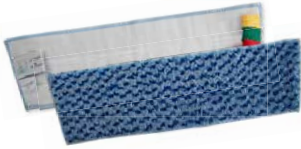

Ideal for scrubbing and wet mopping of non-slip floors and natural terracotta with medium degree of stubborn dirt

MICRO-ACTIVA - ultra-microfiber mop, polyester backing, with strap tape system and colour-coded tag

REF.	NOTES	PCK	VOLUME (m ²)	GROSS WEIGHT (kg)	SIZE (cm) ↓ ↓ ↓
000EPN02012		25	0,011	1,32	30
000EPN03012		25	0,015	1,86	40
000EPN03022		25	0,03	2,77	60

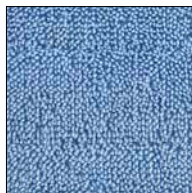
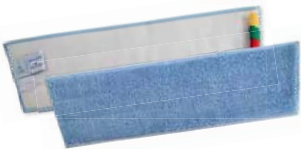

Ideal for industrial floors, single-fired tiles, stoneware and woods with a medium degree of dirt

Handles and safety signs

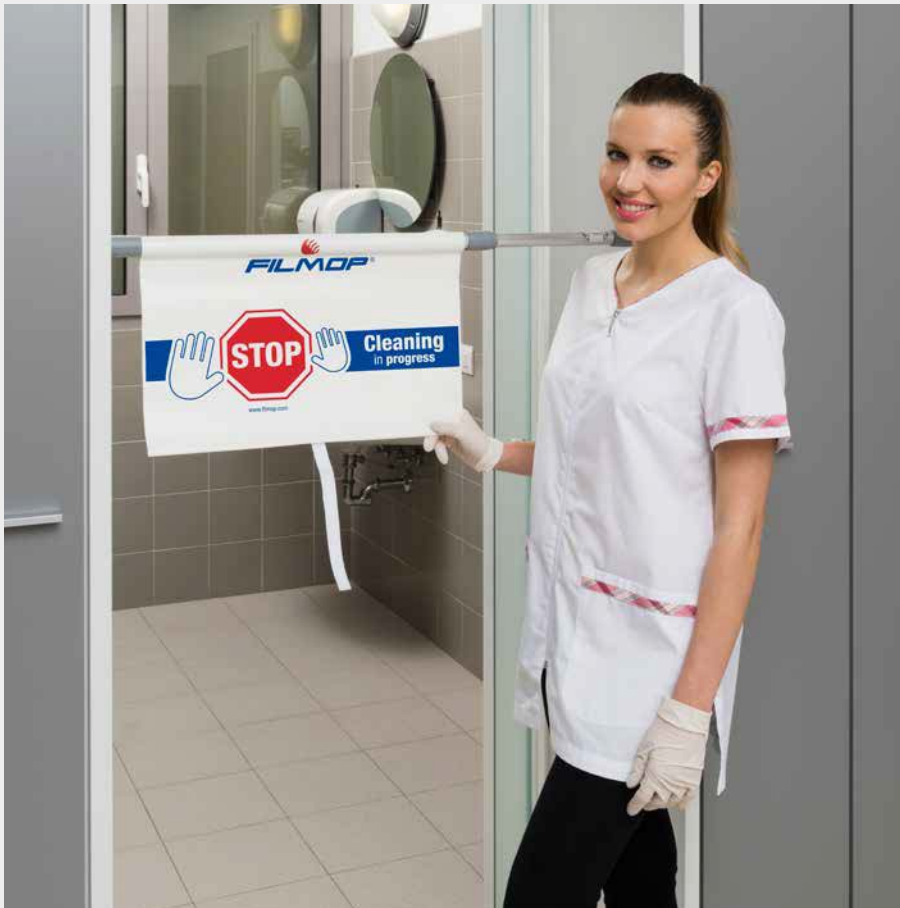

Handles

Warning safety signs





HANDLES

WARNING SAFETY SIGNS

ErgoSwing ergonomic system

HIGH PERFORMANCES, NO EFFORT

ErgoSwing is the innovative system consisting of telescopic handle with turning grip and mop holder with ergonomic joint designed for **easy S movement**.

The system guarantees **less strain** and **increased productivity**, together with better floor cleaning performance.

- **ERGONOMIC:** 360° rotation hand grips for easier movement and sturdy grip
- **SAFE:** the rotation locking mechanism allows to safely place the tool
- **EFFICIENT:** the system offers optimum performance, with significantly less effort required by the operator
- **INTUITIVE:** it features a simple and clear design that makes it particularly easy to use
- **COMFORTABLE:** comfortable and pleasant to use, it ensures the psycho-physical well-being of the operator
- **TELESCOPIC:** the adjustment of the length of the telescopic handle up to the chin helps a correct posture during cleaning operations.



HANDLES AND SAFETY SIGNS

PAT PENDING

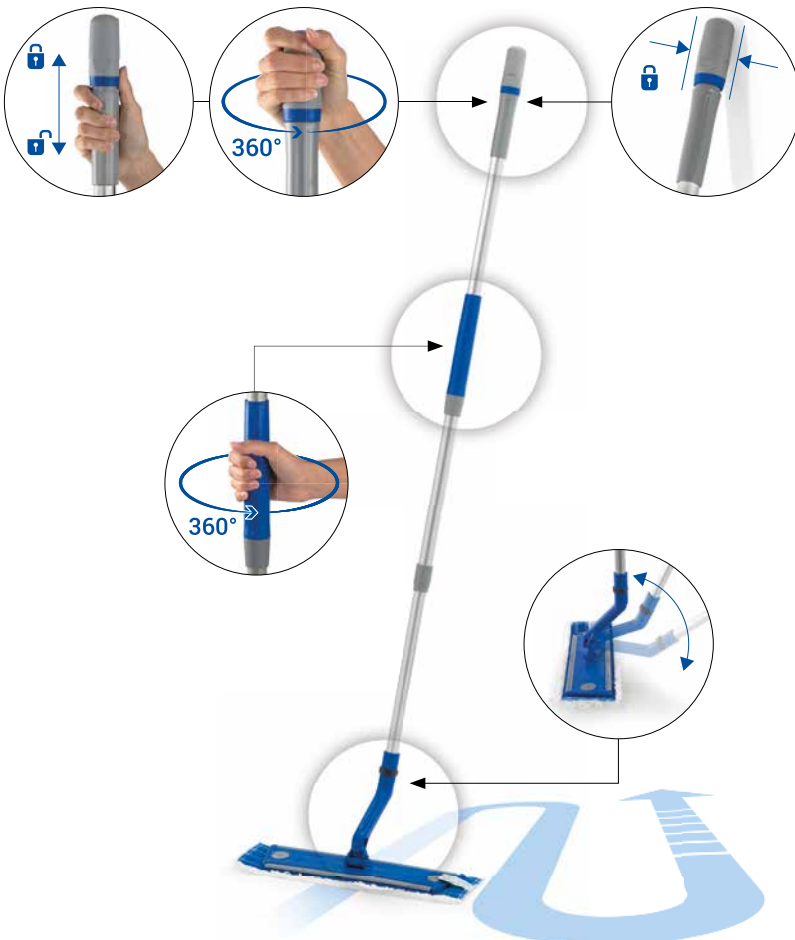

The rotation mechanism of the upper handle can be locked in order to place the tool safely.



ErgoSwing easily cleans even the most difficult to reach places.



HANDLES

WARNING SAFETY SIGNS



CORRECT POSTURE

Continuous improper posture is one of the main risk factors in the appearance of disorders and pathologies affecting the musculoskeletal system over time.

ErgoSwing is designed to **ensure the maintenance of correct posture** while cleaning floors:

- the neck and the trunk remain in a symmetrical position
- the arms do not assume uncomfortable positions
- the shoulders are not forced to elevate
- the elbows are not subjected to extreme flexing or extension
- the forearms are not required to rotate in an extreme manner
- the knees and ankles remain in a neutral position

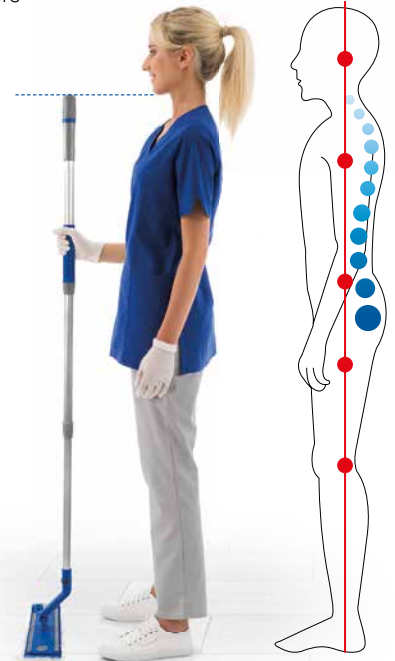

EFFORTLESS

The use analysis found that **the effort made by operators while using ErgoSwing is significantly lower** than that of standard systems.

The notable reduction in effort leads to less fatigue and an increase in operator well-being, resulting in **higher productivity**.

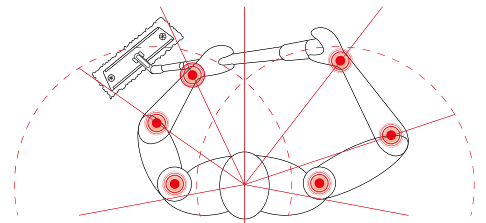

PROVEN ERGONOMICS

In the long term, repeated wrist strain can cause muscle-skeletal issues and pathologies. The ErgoSwing system use analysis conducted by Humana Consulting demonstrates a **significant reduction in wrist bending and extension** when compared with traditional systems: ErgoSwing allows the user to significantly remain below the maximum tolerance area (45°), **preventing the onset of work-related illnesses**.

EXTENSION NEUTRAL FLEXION

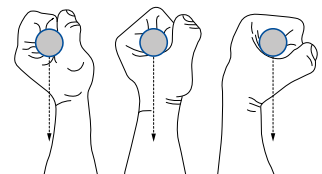

WRIST MOVEMENT WITH THE ERGOSWING

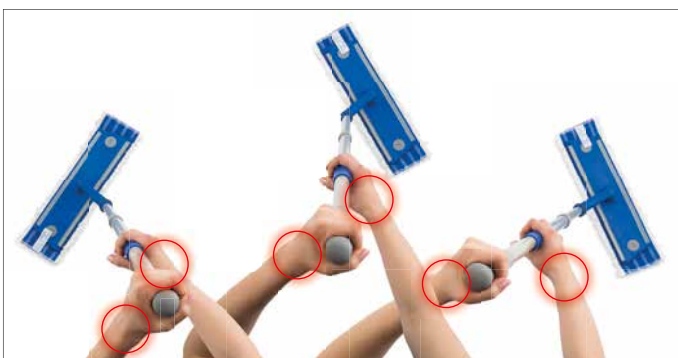

ErgoSwing limits wrist movement, thus **reducing effort**

WRIST MOVEMENT WITH STANDARD SYSTEMS

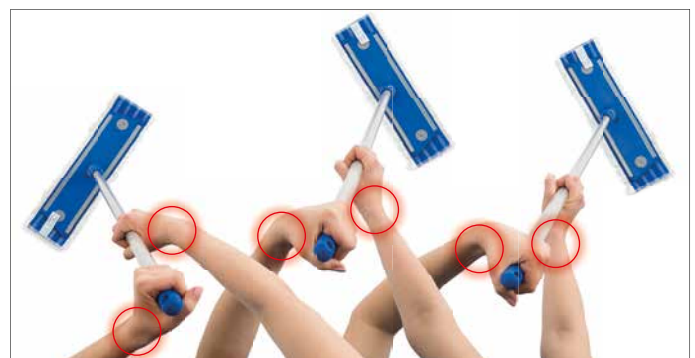

Standard systems force the wrist to fully extend



HANDLES

WARNING SAFETY SIGNS

Aluminium telescopic handles

2-piece anodized aluminium telescopic handle for ErgoSwing system with turning grips and coloured insert



REF.	NOTES	PCK	VOLUME (m³)	GROSS WEIGHT (kg)	SIZE (cm) ↓ ↓ ↓
0000AM3045A	blue, with blue insert	10	0,022	6,07	184
0000AM3045UU	grey, with grey insert	10	0,022	6,07	184
0000AM3045UA	grey, with blue insert	10	0,022	6,07	184
0000AM3045UB	grey, with red insert	10	0,022	6,07	184
0000AM3045UC	grey, with yellow insert	10	0,022	6,07	184
0000AM3045UF	grey, with green insert	10	0,022	6,07	184

Extends from 106 to 184 cm - External tube ø 26 mm, internal tube ø 23 mm

2-piece anodized aluminium telescopic handle with ergonomic grip and coloured cap



REF.	NOTES	PCK	VOLUME (m³)	GROSS WEIGHT (kg)	SIZE (cm) ↓ ↓ ↓
0000AM3070A	blue, with blue cap	10	0,02	4,38	184
0000AM3070UU	grey, with grey cap	10	0,02	4,38	184
0000AM3070UA	grey, with blue cap	10	0,02	4,38	184
0000AM3070UB	grey, with red cap	10	0,02	4,38	184
0000AM3070UC	grey, with yellow cap	10	0,02	4,38	184
0000AM3070UF	grey, with green cap	10	0,02	4,38	184
0000AM3090A	blue, with blue cap	10	0,012	2,98	93

Art. 0000AM3070 extendable from 102 to 184 cm - Art. 0000AM3090A extendable from 56 to 93 cm - External tube ø 26 mm, internal tube ø 23 mm

Anodized aluminium telescopic handle in 2 pcs with ergonomic grip, blue cap and end cone with Italian thread



REF.	NOTES	PCK	VOLUME (m³)	GROSS WEIGHT (kg)	SIZE (cm) ↓ ↓ ↓
0000AM3170A	blue, with blue cap	10	0,02	5,48	184

Extendible form 102 to 184 cm - External tube ø 26 mm, internal tube ø 23 mm



HANDLES

WARNING SAFETY SIGNS

Anodized aluminium telescopic handle with anti-bacterial components - 2 pcs



REF.	NOTES	PCK	VOLUME (m³)	GROSS WEIGHT (kg)	SIZE (cm) ↓ ↓ ↓
0000AM3040FZ		10	0,014	4,69	182

Extendible from 100 to 182 cm - External tube ø 26 mm, internal tube ø 23 mm

2-piece telescopic anodized aluminium handle



REF.	NOTES	PCK	VOLUME (m³)	GROSS WEIGHT (kg)	SIZE (cm) ↓ ↓ ↓
0000AM3060A		50	0,064	23,28	140

Extends from 79 to 140 cm - External tube ø 26 mm, internal tube ø 23 mm

Accessories for handles

End cone with Italian thread for telescopic handles and 3-hole aluminum handles ø 23 mm



REF.	NOTES
P179040A	



HANDLES

WARNING SAFETY SIGNS

Wooden handles

Varnished wooden handle \varnothing 24 mm with Italian screw and hole

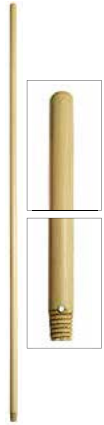

REF.	NOTES	PCK	VOLUME (m ³)	GROSS WEIGHT (kg)	SIZE (cm) ↓ ↓ ↓
0000LM30023		50	0,043	11,8	130
0000LM30003		50	0,049	27,2	150

Thanks to their hole and screw, these handles can be used both with mop holders with screw and with the ones with ring

Wooden handle

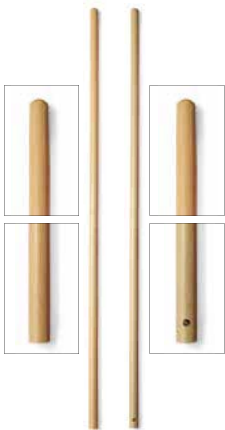

REF.	NOTES	PCK	VOLUME (m ³)	GROSS WEIGHT (kg)	SIZE (cm) ↓ ↓ ↓
1057	\varnothing 24 mm for industrial brooms	50	0,046	20	140
1070	\varnothing 30 mm with hole for Street brooms	10	0,012	5,2	145

Chromed metal handles

Chromed metal handle with hole \varnothing 22 mm - 2 pcs



REF.	NOTES	PCK	VOLUME (m ³)	GROSS WEIGHT (kg)	SIZE (cm) ↓ ↓ ↓
1053A		25	0,031	16,24	140
1054		25	0,031	14,99	130



HANDLES

WARNING SAFETY SIGNS

Aluminium handles

Anodized aluminium handle \varnothing 23 mm with 3 holes, coloured grip

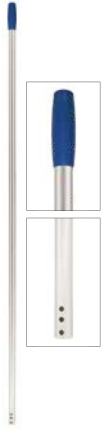

REF.	NOTES	PCK	VOLUME (m ³)	GROSS WEIGHT (kg)	SIZE (cm) ↓ ↓ ↓
0000AM30025		25	0,037	7,25	130
0000AM30015		25	0,034	5,65	140
0000AM30015B		25	0,034	5,65	140
0000AM30015C		25	0,034	5,65	140
0000AM30015F		25	0,034	5,65	140
0000AM30015U		25	0,034	5,65	140
0000AM30005		25	0,038	7,75	150

The 3 holes allow the use of the handle with several and different mop holders

Anodized aluminium handle \varnothing 22 mm, with plastic Italian thread



REF.	NOTES	PCK	VOLUME (m ³)	GROSS WEIGHT (kg)	SIZE (cm) ↓ ↓ ↓
0000AM30010		25	0,034	6,47	140
0000AM30020		25	0,041	5,93	130

Upon request, it is available with coloured grip

Glass fiber handles

Glass fiber handle \varnothing 23,5 mm with hole

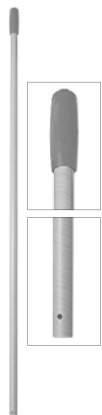

REF.	NOTES	PCK	VOLUME (m ³)	GROSS WEIGHT (kg)	SIZE (cm) ↓ ↓ ↓
1069E		25	0,042	9,15	145



HANDLES

WARNING SAFETY SIGNS

Coated metal handles

Varnished iron handle \varnothing 22 mm with Italian thread

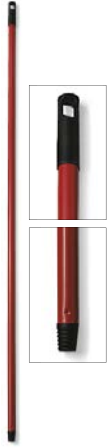

REF.	NOTES	PCK	VOLUME (m ³)	GROSS WEIGHT (kg)	SIZE (cm) ↓ ↓ ↓
1059		10	0,007	2,3	130

Coated iron handle \varnothing 24 mm, 4 pieces, with Italian thread

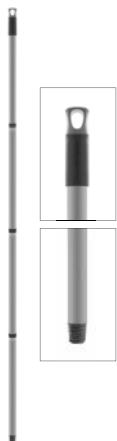

REF.	NOTES	PCK	VOLUME (m ³)	GROSS WEIGHT (kg)	SIZE (cm) ↓ ↓ ↓
1065		36	0,053	15,41	140



Plastic coated metal handles

Plastic coated telescopic metal handle \varnothing 22 mm with cone - 2 pcs



REF.	NOTES	PCK	VOLUME (m ³)	GROSS WEIGHT (kg)	SIZE (cm) ↓ ↓ ↓
2015		12	0,02	7,8	300



HANDLES

WARNING SAFETY SIGNS

Drop: tank handle

Thanks to Drop floor wet mopping is **easy**, **quick** and **efficient**:

- **Cleans** and **sanitises** every surface **in an instant**
- Lightweight, handy and **easy to use**
- **Prevents spillage** of cleaning solution



SMART DESIGN



Its tank has a 500 ml capacity and can be easily filled by means of a specific jug



The practical flap with rubber gasket assures an airtight seal



PAT. PENDING

The ring, with a patent pending closing system of the tank, prevents from accidental spillage



The push button allows you to activate the immediate dispensing of the cleaning solution



The three nozzles allow the cleaning solution to exit directly onto the surface to clean



It is possible to clean easily also the most difficult to reach areas thanks to its compact size

ErgoDrop: ergonomic tank handle

ErgoDrop combines the advantages of the professional Drop system with those of the innovative ergonomic ErgoSwing system, ensuring **maximum results with minimum effort**.

- Designed to **safeguard the operator's health**
- **It makes cleaning easier**, considerably reducing efforts
- **It assures high performances** and increases productivity





HANDLES

WARNING SAFETY SIGNS

Handles with tank

DROP - tank handle 500 ml



REF.	NOTES	PCK	VOLUME (m³)	GROSS WEIGHT (kg)	SIZE (cm) ↓ ↓ ↓
0000TD0600A		5	0,019	3,19	142



ERGODROP - tank handle 500 ml with turning grips for ErgoSwing system



REF.	NOTES	PCK	VOLUME (m³)	GROSS WEIGHT (kg)	SIZE (cm) ↓ ↓ ↓
0000TD0500A		5	0,019	3,41	142





Safety signs - 2 parts and 3 parts

Monolingual plastic safety sign "caution wet floor", 2 parts



REF.	NOTES	PCK	VOLUME (m³)	GROSS WEIGHT (kg)	SIZE (cm) ↓ ↓ ↓
60068614	Without writing and without graphic symbol	5	0,026	4,02	42x23x57
8614.0	Without writing but with graphic symbol	5	0,026	4,02	42x23x57
8614	in Italian "ATTENZIONE PAVIMENTO BAGNATO"	5	0,026	4,02	42x23x57
8614GB	in English "CAUTION WET FLOOR"	5	0,026	4,02	42x23x57
8614D	in German "ACHTUNG RUTSCHGEFAHR"	5	0,026	4,02	42x23x57
8614F	in French "ATTENTION SOL GLISSANT"	5	0,026	4,02	42x23x57

On request available in other languages or in bilingual version (with one different language on every side)

Monolingual plastic safety sign "caution wet floor", 3 parts



REF.	NOTES	PCK	VOLUME (m³)	GROSS WEIGHT (kg)	SIZE (cm) ↓ ↓ ↓
60068624	Without writing and without graphic symbol	5	0,04	6,11	42x23x104
8624.0	Without writing but with graphic symbol	5	0,04	6,11	42x23x104
8624	in Italian "ATTENZIONE PAVIMENTO BAGNATO"	5	0,04	6,11	42x23x104
8624GB	in English "CAUTION WET FLOOR"	5	0,04	6,11	42x23x104
8624D	in German "ACHTUNG RUTSCHGEFAHR"	5	0,04	6,11	42x23x104
8624F	in French "ATTENTION SOL GLISSANT"	5	0,04	6,11	42x23x104

On request available in other languages or in bilingual version (with one different language on every side)

Monolingual plastic safety sign "caution wet floor", 3 parts with check-list holder



REF.	NOTES	PCK	VOLUME (m³)	GROSS WEIGHT (kg)	SIZE (cm) ↓ ↓ ↓
60068654	Without writing and without graphic symbol	4	0,04	8,36	42x23x104
8654.0	Without writing but with graphic symbol	4	0,04	8,36	42x23x104
8654	in Italian "PAVIMENTO BAGNATO"	4	0,04	8,36	42x23x104
8654GB	in English "WET FLOOR"	4	0,04	8,36	42x23x104
8654D	in German "ACHTUNG RUTSCHGEFAHR"	4	0,04	8,36	42x23x104
8654F	in French "SOL GLISSANT"	4	0,04	8,36	42x23x104

On request available in other languages or in bilingual version (with one different language on every side)



HANDLES

WARNING SAFETY SIGNS

Conical safety sign

Conical plastic safety sign



REF.	NOTES	PCK	VOLUME (m³)	GROSS WEIGHT (kg)	SIZE (cm)
8634	h 93 cm	5	0,183	9,27	93



Accessories for safety signs

Plastic chain for safety sign composed of 12 elements

REF.	NOTES
P250001C	length 1 mt



Weight 0,5 kgs for conical safety sign with screws



REF.	NOTES	PCK	VOLUME (m³)	GROSS WEIGHT (kg)
V250004H		30	0,008	19,56

Red flashing light for conical safety sign



REF.	NOTES	PCK	VOLUME (m³)	GROSS WEIGHT (kg)
P250002	battery power: 2 batteries 1,5V necessary	6	0,006	0,6





HANDLES

WARNING SAFETY SIGNS

Round plastic board for conical safety sign



REF.	NOTES		PCK	VOLUME (m³)	GROSS WEIGHT (kg)
P230001B	"no entry"		5	0,005	0,52
P230002A	"directional arrow"		5	0,005	0,52
P230003C	in Italian "ATTENZIONE PAVIMENTO BAGNATO"		5	0,005	0,52
P230GB3C	in English "CAUTION WET FLOOR"		5	0,005	0,52
P2300D3C	in German "ACHTUNG RUTSCHGEFAHR"		5	0,005	0,52
P2300F3C	in French "ATTENTION SOL MOUILLE"		5	0,005	0,52

Rectangular plastic board for conical safety sign



REF.	NOTES		PCK	VOLUME (m³)	GROSS WEIGHT (kg)
P240001C	in Italian "ATTENZIONE PAVIMENTO BAGNATO"		5	0,028	2
P240GB1C	in English "CAUTION WET FLOOR"		5	0,028	2
P2400D1C	in German "ACHTUNG RUTSCHGEFAHR"		5	0,028	2
P240002C	in Italian "PULIZIA IN CORSO"		5	0,028	2
P240GB2C	in English "CLEANING IN PROGRESS"		5	0,028	2
P2400D2C	in German "REINIGUNGSARBEITEN"		5	0,028	2
P240003C	in Italian "FUORI SERVIZIO"		5	0,028	2
P240GB3C	in English "OUT OF SERVICE"		5	0,028	2
P2400D3C	in German "AUSSER BETRIEB"		5	0,028	2
P2400F3C	in French "HORS SERVICE"		5	0,028	2
P240004B	in Italian "CHIUSO"		5	0,028	2
P240GB4B	in English "CLOSED"		5	0,028	2
P2400D4B	in German "GESCHLOSSEN"		5	0,028	2
P2400F4B	in French "FERME"		5	0,028	2

Safety sign for door

Safety sign for door "Cleaning in progress" with suction caps



REF.	NOTES	PCK	VOLUME (m³)	GROSS WEIGHT (kg)
9310		10	0,016	4,73



Can be extended from 77 to 134 cm - Can be applied by suction cups - Customizable PVC sheeting



Buckets and wringer trolleys

Bucket/wringer combos

Plastic mop trolleys

Chromed and Rilsan coated trolleys

Wringers

Multi-purpose buckets

Top-Down® buckets

Other plastic buckets

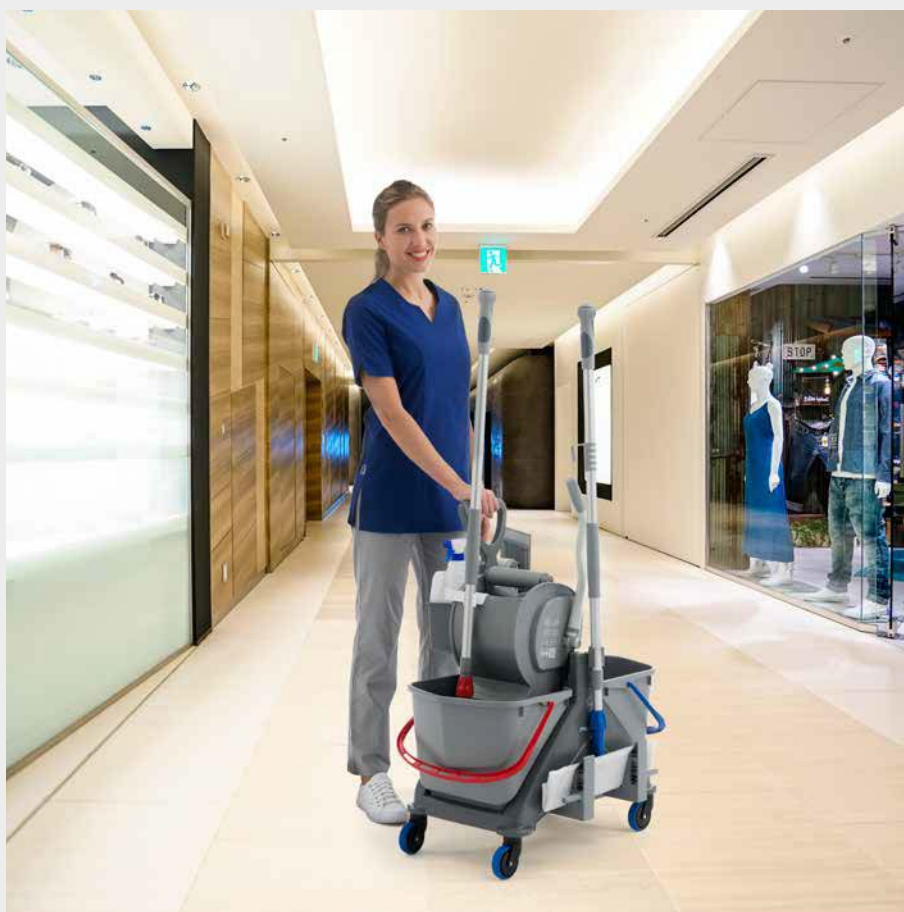

Buckets and wringer trolleys



- BUCKET/WRINGER COMBOS
- PLASTIC MOP TROLLEYS
- CHROMED AND RILSAN COATED TROLLEYS
- WRINGERS
- MULTI-PURPOSE BUCKETS
- TOP-DOWN® BUCKETS
- OTHER PLASTIC BUCKETS

Single buckets

PLUTO - plastic bucket 12 L with handle and sieve



REF.	NOTES	PCK	VOLUME (m³)	GROSS WEIGHT (kg)	SIZE (cm) ↓ ↓ ↓
2070A		12	0,114	7,25	35x28x30
2070B		12	0,114	7,25	35x28x30
2070C		12	0,114	7,25	35x28x30
2070F		12	0,114	7,25	35x28x30

MASTER LUX - plastic bucket 16 L with handle and sieve



REF.	NOTES	PCK	VOLUME (m³)	GROSS WEIGHT (kg)	SIZE (cm) ↓ ↓ ↓
2080A		10	0,113	8,48	36x27x35
2080B		10	0,113	8,48	36x27x35
2080C		10	0,113	8,48	36x27x35
2080F		10	0,113	8,48	36x27x35



GEMINI - plastic bucket 15 L with 2 compartments, 2 handles and sieve



REF.	NOTES	PCK	VOLUME (m³)	GROSS WEIGHT (kg)	SIZE (cm) ↓ ↓ ↓
2060A		6	0,101	8,21	42x28x33
2060B		6	0,101	8,21	42x28x33



BUCKETS AND WRINGER TROLLEYS

JUMPY - single shockproof plastic bucket 30 L



REF.	PCK	VOLUME (m³)	GROSS WEIGHT (kg)	SIZE (cm) ↓ ↓ ↓
0000SL2700C	1	0,145	5,88	47x40x93
00SSSL2700C	Bucket 30 L with wheels for Jumpy bucket			1 pc.
7004A	REGULAR - blue plastic down-press wringer with plastic gears			1 pc.



BABY - shockproof plastic single bucket 25 L



REF.	PCK	VOLUME (m³)	GROSS WEIGHT (kg)	SIZE (cm) ↓ ↓ ↓
7970CGB	1	0,106	6,35	46x41x80
7004A	REGULAR - blue plastic down-press wringer with plastic gears			1 pc.
7971CGBSS	Bucket 25 L with wheels for Baby bucket			1 pc.

KING - shockproof plastic single bucket 15 L



REF.	PCK	VOLUME (m³)	GROSS WEIGHT (kg)	SIZE (cm) ↓ ↓ ↓
7940CGB		1	0,054	44x31x71
7940AGB		1	0,054	44x31x71
7941CGBSS	Bucket 15 L with wheels for King bucket			1 pc.
8002A	Plastic side-press wringer			1 pc.

OSCAR - shockproof plastic single bucket 30 L



REF.	PCK	VOLUME (m³)	GROSS WEIGHT (kg)	SIZE (cm) ↓ ↓ ↓
0000SL2602C	1	0,145	6,47	55x37x93
00SSSL2602C	Bucket 30 L with wheels for Oscar bucket			1 pc.
7004A	REGULAR - blue plastic down-press wringer with plastic gears			1 pc.

Buckets and wringer trolleys



BUCKET/WRINGER COMBOS

PLASTIC MOP TROLLEYS

CHROMED AND RILSAN COATED TROLLEYS

WRINGERS

MULTI-PURPOSE BUCKETS

TOP-DOWN® BUCKETS

OTHER PLASTIC BUCKETS

Twice is the double bucket with wringer for professional floor wet mopping, designed to guarantee the best service and profitability during cleaning operations.

It has a total 30 L capacity and it is equipped **with two drain-plugs**; thanks to its two compartments, it separates clean solution from rinsing water.

The bucket can be piled up thanks to the plastic feet that can be easily unassembled saving transport and storing costs.

It fits all Filmop plastic wringers.



Two compartments 16 L + 14 L



Two separate drain-plugs



Stackable

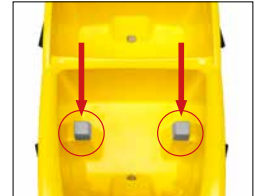

Specific wringer adaptor-plugs for Punto, Deep and Boost wringers

TWICE - shockproof plastic bucket 30 L with two drain-plugs and Regular wringer



REF.	PCK	VOLUME (m³)	GROSS WEIGHT (kg)	SIZE (cm) ↓ ↓ ↓
0000SL2800C	1	0,142	6,23	60x40x93
00SSSL2800C	Bucket 16+14 L with wheels and two drain-plugs for Twice bucket			1 pc.
7004A	REGULAR - blue plastic down-press wringer with plastic gears			1 pc.

TWICE - shockproof plastic bucket 30 L with two drain-plugs and Punto wringer



REF.	PCK	VOLUME (m³)	GROSS WEIGHT (kg)	SIZE (cm) ↓ ↓ ↓
0022SL2800C	1	0,142	7,24	60x40x93
0000SM00031U	Set of 2 grey adaptor-plugs 1A+2A for wringers art. 14000-12000-10000			1 pc.
00SSSL2800C	Bucket 16+14 L with wheels and two drain-plugs for Twice bucket			1 pc.
14000A	PUNTO - plastic roll wringer central position, blue			1 pc.

TWICE - shockproof plastic bucket 30 L with two drain-plugs and Deep wringer



REF.	PCK	VOLUME (m³)	GROSS WEIGHT (kg)	SIZE (cm) ↓ ↓ ↓
0006SL2800C	1	0,142	6,44	60x40x93
0000SM00030C	Set of 2 yellow adaptor-plugs 1B+2B for wringer art. 7002			1 pc.
00SSSL2800C	Bucket 16+14 L with wheels and two drain-plugs for Twice bucket			1 pc.
7002A	DEEP - plastic side press wringer without bottom			1 pc.

BUCKET/WRINGER COMBOS | **PLASTIC MOP TROLLEYS** | **CHROMED AND RILSAN COATED TROLLEYS** | **WRINGERS** | **MULTI-PURPOSE BUCKETS** | **TOP-DOWN® BUCKETS** | **OTHER PLASTIC BUCKETS**

MAXI JOLLY - shockproof plastic single bucket 30 L with divider and drain-plug



REF.	PCK	VOLUME (m³)	GROSS WEIGHT (kg)	SIZE (cm) ↓ ↓ ↓
0000SL2601C	1	0,145	7,52	55x37x93
00SSSL2601C 7002A	Bucket 30 L whit drain-plug, divider and wheels for Maxi Jolly bucket DEEP - plastic side press wringer without bottom			1 pc. 1 pc.



SPIDER - shockproof plastic single bucket 15 L with divider



REF.	PCK	VOLUME (m³)	GROSS WEIGHT (kg)	SIZE (cm) ↓ ↓ ↓
7930AGB		1	0,057	47x27x71
7930CGB		1	0,057	47x27x71
7931AGBSS 8002/1A	Bucket for 15 lt Spider bucket with divider and wheels, blue Plastic side-press wringer with plastic covering			1 pc. 1 pc.



SPIDER MAX - shockproof plastic single bucket 15 L with divider



REF.	PCK	VOLUME (m³)	GROSS WEIGHT (kg)	SIZE (cm) ↓ ↓ ↓
7990AGB		1	0,094	55x27x87
7990CGB		1	0,094	55x27x87
42100A	Bucket support for Spider Max with pirouetting wheels ø 50 mm			1 pc.
60152A	Blue divider for Spider bucket			1 pc.
7932AGB	Blue bucket 15 L without divider and without wheels for Spider bucket			1 pc.
8002/1A	Plastic side-press wringer with plastic covering			1 pc.

RO-CKET WHEELS - single plastic bucket 15 L with rubber rolls, divider and wheels



REF.	NOTES	PCK	VOLUME (m³)	GROSS WEIGHT (kg)	SIZE (cm) ↓ ↓ ↓
0000LP1402C		1	0,074	3,87	44x32x41

RO-CKET - single plastic bucket 15 L with rubber rolls and divider



REF.	NOTES	PCK	VOLUME (m³)	GROSS WEIGHT (kg)	SIZE (cm) ↓ ↓ ↓
0000LP1401C		1	0,063	3,33	44x32x35

Buckets and wringer trolleys



**BUCKET/WRINGER
COMBOS**

PLASTIC MOP
TROLLEYS

CHROMED AND RILSAN
COATED TROLLEYS

WRINGERS

MULTI-PURPOSE
BUCKETS

TOP-DOWN® BUCKETS

OTHER PLASTIC
BUCKETS

Components for wringer buckets

Plastic bucket 12 L with plastic handle for Pluto bucket



REF.	NOTES	PCK	VOLUME (m³)	GROSS WEIGHT (kg)	SIZE (cm) ↓ ↓ ↓
2071A		12	0,114	5,81	35x28x23,5
2071B		12	0,114	5,81	35x28x23,5
2071C		12	0,114	5,81	35x28x23,5
2071F		12	0,114	5,81	35x28x23,5

Plastic sieve for Pluto bucket



REF.	NOTES
2072A	
2072B	
2072C	
2072F	

Plastic bucket 16 L with plastic handle for Master Lux bucket



REF.	NOTES	PCK	VOLUME (m³)	GROSS WEIGHT (kg)	SIZE (cm) ↓ ↓ ↓
2051A		10	0,113	6,84	35x27,5x27,5
2051B		10	0,113	6,84	35x27,5x27,5
2051C		10	0,113	6,84	35x27,5x27,5
2051F		10	0,113	6,84	35x27,5x27,5



Plastic sieve for Master Lux bucket



REF.	NOTES	SIZE (cm) ↓ ↓ ↓
2082A		24x19x14
2082B		24x19x14
2082C		24x19x14
2082F		24x19x14

Plastic bucket 15 L with 2 compartments and 2 plastic handles for Gemini bucket



REF.	NOTES	PCK	VOLUME (m³)	GROSS WEIGHT (kg)	SIZE (cm) ↓ ↓ ↓
2061A		6	0,101	6,83	42x28x27,5
2061B		6	0,101	6,83	42x28x27,5



Plastic sieve for Gemini bucket



REF.	NOTES
2062A	
2062B	

BUCKETS AND WRINGER TROLLEYS

BUCKET/WRINGER COMBOS

PLASTIC MOP TROLLEYS

CHROMED AND RILSAN COATED TROLLEYS

WRINGERS

MULTI-PURPOSE BUCKETS

TOP-DOWN® BUCKETS

OTHER PLASTIC BUCKETS

Bucket 30 L with wheels for Jumpy bucket



REF.	NOTES
00SSSL2700C	

Bucket 25 L with wheels for Baby bucket



REF.	NOTES
7971CGBSS	

Bucket 15 L with wheels for King bucket



REF.	NOTES	SIZE (cm)
7941CGBSS		44x31x34,5

Bucket 30 L with wheels for Oscar bucket



REF.	NOTES
00SSSL2602C	

Bucket 16+14 L with wheels and two drain-plugs for Twice bucket



REF.	NOTES
00SSSL2800C	

If it is used with wringers art. 7002, 14000 and 8004, you have to use the relative wringer adaptor-plugs

Set of adaptor-plugs for wringer for Twice bucket



REF.	NOTES
0000SM00030C	1B+2B - for wringer art. 7002
0000SM00031U	1A+2A - for wringers art. 14000-12000-10000
0000SM00032H	1C+2C - for wringer art. 8004
0000SM00039U	for wringer code 7003

Buckets and wringer trolleys



BUCKET/WRINGER COMBOS

PLASTIC MOP TROLLEYS

CHROMED AND RILSAN COATED TROLLEYS

WRINGERS

MULTI-PURPOSE BUCKETS

TOP-DOWN® BUCKETS

OTHER PLASTIC BUCKETS

Valve for Twice bucket



REF.	NOTES
P190301H	

Bucket 30 L whit drain-plug, divider and wheels for Maxi Jolly bucket



REF.	NOTES
00SSSL2601C	

Divider with 2 lift levers and rubber profile for Maxi Jolly bucket



REF.	NOTES
P390300C	



Valve for Maxi Jolly bucket



REF.	NOTES
P190371H	



Bucket with divider and wheels for 15 lt Spider bucket



REF.	NOTES	SIZE (cm) ↓ ↓ ↓
7931AGBSS		40x28x34
7931CGBSS		40x28x34

Bucket 15 L without divider and without wheels for Spider bucket



REF.	NOTES
7932AGB	
7932CGB	

BUCKETS AND WRINGER TROLLEYS

Divider for Spider bucket



REF.	NOTES
60152A	
60152C	

Bucket support for Spider Max with pirouetting wheels ø 50 mm



REF.	NOTES
42100A	

Duo Pro System: double cleaning in half the time

Duo Pro System is a **professional wet mopping system** composed of a practical bucket with squeezing sieve, available with or without wheels according to the specific needs.

Designed for its use with the **Duo Face reversible mop holder** and **the range of double-faced mops**, it assures the highest efficiency and significant energy, time and cost savings.

- **It reduces strain:** designed to guarantee the highest ergonomics, comfort and simple use
- **It saves time:** thanks to the combined efficiency of mop holder, mop and wringer, the system ensures **double cleaning** with **half the wringing** when compared with traditional systems
- **It reduces waste:** the high level of washing autonomy of microfibre allows to use **significantly less detergent**, therefore also decreasing the impact on the environment

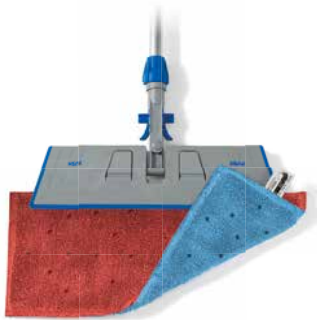

The reversible mop holder and the double-faced mops make cleaning easier: find out more in the Duo Face system section



Suitable also as washing system combined with the Alpha trolley line



How to use it



Soak the mop in the cleaning solution

Insert the mop into the wringer

Lower the lever

Start mopping the floor

Rinse the mop



- BUCKET/WRINGER COMBOS
- PLASTIC MOP TROLLEYS
- CHROMED AND RILSAN COATED TROLLEYS
- WRINGERS
- MULTI-PURPOSE BUCKETS
- TOP-DOWN® BUCKETS
- OTHER PLASTIC BUCKETS

Duo Pro System

DUO PRO SYSTEM - 25l mop bucket with red handle complete with Duo Pro lever-operated wringer



REF.	NOTES	PCK	VOLUME (m³)	GROSS WEIGHT (kg)	SIZE (cm) ↓ ↓ ↓
0020SE1725UB	with castors	1	0,102	5,08	30,5x56x70,5
0020SE0725UB	without castors	1	0,092	4,74	30,5x56x63,5
0000SE0725UB	Grey plastic bucket 25L with red handle				1 pc.
21040U	DUO PRO - lever plastic wringer				1 pc.
7949	Castor ø 50 mm				4 pcs

DUO PRO - plastic lever-operated wringer for DuoFace system



REF.	NOTES	PCK	VOLUME (m³)	GROSS WEIGHT (kg)	SIZE (cm) ↓ ↓ ↓
21040U		4	0,073	9,68	14,5x55x45

Plastic 25l mop bucket for Duo Pro wringer



REF.	NOTES	SIZE (cm) ↓ ↓ ↓
0000SE0725UB	without castors	30,5x56x26
0000SE1725UB	with castors	30,5x56x33



Cleaning becomes easy

Easy Wash is a **compact and handy semi-professional system** designed to make cleaning extremely easy, convenient and fast thanks to the innovative design studied in every detail.

Composed of a touch-free mop holder, microfiber mop and bucket with wringer, it is particularly suitable for washing **horizontal and vertical surfaces** in small areas.



Easy WASH



TOUCH FREE

PAT. PENDING



HIGH PERFORMANCE CLEANING MOP HOLDER AND MOP



- The exclusive **touch-free system** eliminates any hand contact with dirt, preventing the risk of cross-contamination
- The **mop fixing and release system** makes operations quicker and easier, avoiding repeated bending and consequent strain
- The special **micro flaps** are designed to keep the mop fixed to the mop holder, thus preventing accidental release during use
- The **Energy-Fur microfiber** is characterized by its high capillary absorbency, which ensures a great floor coverage and effectiveness in removing dirt

ERGONOMIC WRINGING BUCKET AND WRINGER

- The special **shape of the wringer** facilitates mop wringing
- Built-in **handle holder** allows you to conveniently attach the tool
- The practical **back handle** makes it easy to grip the bucket when emptying
- **Polypropylene** composition ensures high durability and long service life



Mop fixing



Mop releasing

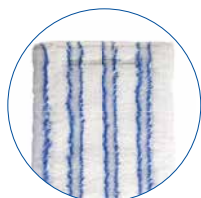

Energy-Fur



Wringer shape

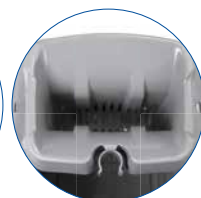

Handle holder

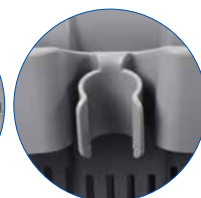

Back handle

Buckets and wringer trolleys



BUCKET/WRINGER
COMBOS

PLASTIC MOP
TROLLEYS

CHROMED AND RILSAN
COATED TROLLEYS

WRINGERS

MULTI-PURPOSE
BUCKETS

TOP-DOWN® BUCKETS

OTHER PLASTIC
BUCKETS

Easy Wash

Kit **EASY WASH** - bucket 15L complete with sieve, mop holder and mop

REF.	NOTES		PCK	VOLUME (m³)	GROSS WEIGHT (kg)	SIZE (cm) ↓ ↓ ↓
0000SE2815UA	blue bucket handle and blue components of the mop holder		1	0,036	1,69	37x30x37,5
0000SE2815UB	red bucket handle and red mop holder screw		1	0,036	1,69	37x30x37,5
0000SE2815UC	yellow bucket handle and yellow mop holder screw		1	0,036	1,69	37x30x37,5
0000SE2815UF	green bucket handle and green mop holder screw		1	0,036	1,69	37x30x37,5
0000SE0815UA	Platic bucket 15L for Easy Wash, grey with blue handle					1 pc.
0000TP0011UA	EASY WASH - plastic mop holder with flaps					1 pc.
00PN0311N00	ENERGY-FUR - white microfibre mop with blue stripes and abrasive, polyester backing, flaps and colour-coded tags, 35 cm					1 pc.
21020U	Easy Wash plastic sieve					1 pc.



Kit **EASY WASH** - bucket 15L complete with sieve, mop holder, mop and 4 pieces handle

REF.	NOTES	PCK	VOLUME (m³)	GROSS WEIGHT (kg)	SIZE (cm) ↓ ↓ ↓
0000SE3815UA		1	0,036	2,09	37x30x37,5
0000SE0815UA	Platic bucket 15L for Easy Wash, grey with blue handle				1 pc.
0000TP0511UA	EASY WASH MOP HOLDER - foldable plastic mop holder with flaps, joint with thread, 35x10 cm				1 pc.
00PN0311N00	ENERGY-FUR - white microfibre mop with blue stripes and abrasive, polyester backing, flaps and colour-coded tags, 35 cm				1 pc.
1065	Coated iron handle ø 24 mm 4 pieces with Italian thread, 140 cm				1 pc.
21020U	Easy Wash plastic sieve				1 pc.



EASY WASH - plastic bucket 15 L with handle and sieve

REF.	NOTES		PCK	VOLUME (m³)	GROSS WEIGHT (kg)	SIZE (cm) ↓ ↓ ↓
0000SE1815UA			1	0,036	1,36	37x30x37,5
0000SE1815UB			1	0,036	1,36	37x30x37,5
0000SE1815UC			1	0,036	1,36	37x30x37,5
0000SE1815UF			1	0,036	1,36	37x30x37,5



ENERGY-FUR white microfibre mop with blue stripes and abrasive, TNT backing, with flaps for Easy Wash system and colour-coded tags

REF.	NOTES	PCK	VOLUME (m³)	GROSS WEIGHT (kg)	SIZE (cm) ↓ ↓ ↓
00PN0311N00		10	0,01	1,04	35x15

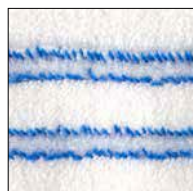

Ideal for all smooth flooring, medium degree of dirt

BUCKET/WRINGER COMBOS |
 PLASTIC MOP TROLLEYS |
 CHROMED AND RILSAN COATED TROLLEYS |
 WRINGERS |
 MULTI-PURPOSE BUCKETS |
 TOP-DOWN® BUCKETS |
 OTHER PLASTIC BUCKETS

EASY WASH MOP HOLDER - foldable plastic mop holder with flaps



REF.	NOTES	PCK	VOLUME (m³)	GROSS WEIGHT (kg)	SIZE (cm)
0000TP0011UA		5	0,01	1,81	35x10
0000TP0011UB		5	0,01	1,81	35x10
0000TP0011UC		5	0,01	1,81	35x10
0000TP0011UF		5	0,01	1,81	35x10

EASY WASH MOP HOLDER - foldable plastic mop holder with flaps, joint with thread



REF.	NOTES	PCK	VOLUME (m³)	GROSS WEIGHT (kg)	SIZE (cm)
0000TP0511U		5	0,01	1,68	35x10



2-piece anodized aluminium telescopic handle with ergonomic grip and coloured cap



REF.	NOTES	PCK	VOLUME (m³)	GROSS WEIGHT (kg)	SIZE (cm)
0000AM3070A	blue, with blue cap	10	0,02	4,38	184
0000AM3070UU	grey, with grey cap	10	0,02	4,38	184
0000AM3070UA	grey, with blue cap	10	0,02	4,38	184
0000AM3070UB	grey, with red cap	10	0,02	4,38	184
0000AM3070UC	grey, with yellow cap	10	0,02	4,38	184
0000AM3070UF	grey, with green cap	10	0,02	4,38	184
0000AM3090A	blue, with blue cap	10	0,012	2,98	93

Art. 0000AM3070 extendable from 102 to 184 cm - Art. 0000AM3090A extendable from 56 to 93 cm - External tube ø 26 mm, internal tube ø 23 mm

Coated iron handle ø 24 mm, 4 pieces, with Italian thread

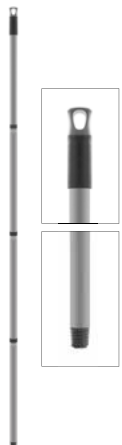

REF.	NOTES	PCK	VOLUME (m³)	GROSS WEIGHT (kg)	SIZE (cm)
1065		36	0,053	15,41	140

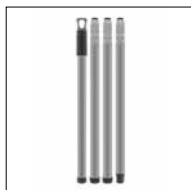

Buckets and wringer trolleys



BUCKET/WRINGER
COMBOS

PLASTIC MOP
TROLLEYS

CHROMED AND RILSAN
COATED TROLLEYS

WRINGERS

MULTI-PURPOSE
BUCKETS

TOP-DOWN® BUCKETS

OTHER PLASTIC
BUCKETS



OneFred is an **innovative and compact wet mopping system**:

- Modern design, conceived for maximum ergonomics.
- Designed to be light, compact and resistant at the same time
- It assures the maximum versatility: one frame for buckets 15L and 25L, simple and quick to assemble
- With innovative, handy and safe coupling system on Alpha trolleys

Commitment towards environmental sustainability

OneFred trolleys are partly made of plastic components certified **Plastic Second Life** according to the Green Public Procurements environmental policies.



BUCKETS AND
WRINGER TROLLEYS

OneFred trolleys

ONEFRED - 30 L plastic trolley with Rilsan coated push-bar



REF.	PCK	VOLUME (m³)	GROSS WEIGHT (kg)	SIZE (cm) ↓ ↓ ↓
000LF1030YU	1	0,176	7,76	80x41x84
0000SE0115UA			Grey plastic bucket 15 L with blue plastic handle for OneFred trolley	1 pc.
0000SE0115UB			Grey plastic bucket 15 L with red plastic handle for OneFred trolley	1 pc.
7004E			REGULAR - grey plastic down-press wringer with plastic gears	1 pc.
8730YSS			Plastic frame with ø 80 mm wheels for OneFred 30 L and 50 L	1 pc.
R8061/2			Rilsan coated push-bar ø 18 mm for OneFred	1 pc.

ONEFRED - plastic trolley 50 L with Rilsan coated push-bar



REF.	PCK	VOLUME (m³)	GROSS WEIGHT (kg)	SIZE (cm) ↓ ↓ ↓
000LF1050YU	1	0,176	8,7	82x41x84
0000SE0125UA			Grey plastic bucket 25 L with blue plastic handle for OneFred trolley	1 pc.
0000SE0125UB			Grey plastic bucket 25 L with red plastic handle for OneFred trolley	1 pc.
7004E			REGULAR - grey plastic down-press wringer with plastic gears	1 pc.
8730YSS			Plastic frame with ø 80 mm wheels for OneFred 30 L and 50 L	1 pc.
R8061/2			Rilsan coated push-bar ø 18 mm for OneFred	1 pc.



PRODUCT PARTIALLY MADE OF PLASTIC COMPONENTS CERTIFIED PSV - PLASTIC SECOND LIFE

BUCKET/WRINGER
COMBOS

**PLASTIC MOP
TROLLEYS**

CHROMED AND RILSAN
COATED TROLLEYS

WRINGERS

MULTI-PURPOSE
BUCKETS

TOP-DOWN® BUCKETS

OTHER PLASTIC
BUCKETS

ONEFRED - plastic trolley 30 L with plastic grip



REF.	PCK	VOLUME (m³)	GROSS WEIGHT (kg)	SIZE (cm) ↓ ↓ ↓
000LF0030YU	1	0,137	6,85	65x39x87
0100LF0030YU	2	0,217	12,7	65x39x87
0000SE0115UA	Grey plastic bucket 15 L with blue plastic handle for OneFred trolley			1 pc.
0000SE0115UB	Grey plastic bucket 15 L with red plastic handle for OneFred trolley			1 pc.
7004E	REGULAR - grey plastic down-press wringer with plastic gears			1 pc.
8730YSS	Plastic frame with ø 80 mm wheels for OneFred 30 L and 50 L			1 pc.
8731Y	Plastic grip for OneFred trolley			1 pc.

ONEFRED - plastic trolley 50 L with plastic grip



REF.	PCK	VOLUME (m³)	GROSS WEIGHT (kg)	SIZE (cm) ↓ ↓ ↓
000LF0050YU	1	0,151	7,17	73x40x87
0100LF0050YU	2	0,244	13,21	73x40x87
0000SE0125UA	Grey plastic bucket 25 L with blue plastic handle for OneFred trolley			1 pc.
0000SE0125UB	Grey plastic bucket 25 L with red plastic handle for OneFred trolley			1 pc.
7004E	REGULAR - grey plastic down-press wringer with plastic gears			1 pc.
8730YSS	Plastic frame with ø 80 mm wheels for OneFred 30 L and 50 L			1 pc.
8731Y	Plastic grip for OneFred trolley			1 pc.

ONEFRED - 30l plastic trolley with plastic handle, caddy and mop holder



REF.	PCK	VOLUME (m³)	GROSS WEIGHT (kg)	SIZE (cm) ↓ ↓ ↓
000LF0031YU	1	0,192	7,8	53x65x87
0000SE0115UA	Grey plastic bucket 15 L with blue plastic handle for OneFred trolley			1 pc.
0000SE0115UB	Grey plastic bucket 15 L with red plastic handle for OneFred trolley			1 pc.
0000SM00299	Mop holder kit for OneFred trolley			1 pc.
60406Y	Plastic carry basket for OneFred			1 pc.
7004E	REGULAR - grey plastic down-press wringer with plastic gears			1 pc.
8730YSS	Plastic frame with ø 80 mm wheels for OneFred 30 L and 50 L			1 pc.
8731Y	Plastic grip for OneFred trolley			1 pc.



ONEFRED - 50l plastic trolley with plastic handle, caddy and mop holder



REF.	PCK	VOLUME (m³)	GROSS WEIGHT (kg)	SIZE (cm) ↓ ↓ ↓
000LF0051YU	1	0,192	8	53x73x87
0000SE0125UA	Grey plastic bucket 25 L with blue plastic handle for OneFred trolley			1 pc.
0000SE0125UB	Grey plastic bucket 25 L with red plastic handle for OneFred trolley			1 pc.
0000SM00299	Mop holder kit for OneFred trolley			1 pc.
60406Y	Plastic carry basket for OneFred			1 pc.
7004E	REGULAR - grey plastic down-press wringer with plastic gears			1 pc.
8730YSS	Plastic frame with ø 80 mm wheels for OneFred 30 L and 50 L			1 pc.
8731Y	Plastic grip for OneFred trolley			1 pc.



PRODUCT PARTIALLY MADE OF PLASTIC COMPONENTS CERTIFIED PSV - PLASTIC SECOND LIFE



BUCKET/WRINGER
COMBOS

**PLASTIC MOP
TROLLEYS**

CHROMED AND RILSAN
COATED TROLLEYS

WRINGERS

MULTI-PURPOSE
BUCKETS

TOP-DOWN® BUCKETS

OTHER PLASTIC
BUCKETS

Fred trolleys

FRED - plastic trolley 30 L with painted push-bar



REF.	PCK	VOLUME (m³)	GROSS WEIGHT (kg)	SIZE (cm) ↓ ↓ ↓
7960A	1	0,148	8,24	87x41x90
7004A	REGULAR - blue plastic down-press wringer with plastic gears			1 pc.
8108A	Blue plastic bucket 15 L with plastic handle			1 pc.
8108B	Red plastic bucket 15 L with plastic handle			1 pc.
8331SS	Plastic frame with wheels ø 80 mm for Fred trolley 30 L			1 pc.
R8061/1	Rilsan coated push-bar ø 18 mm for Fred trolley			1 pc.

FRED - plastic trolley 50 L with painted push-bar



REF.	PCK	VOLUME (m³)	GROSS WEIGHT (kg)	SIZE (cm) ↓ ↓ ↓
7965A	1	0,177	9,42	87x42x90
7004A	REGULAR - blue plastic down-press wringer with plastic gears			1 pc.
8107A	Blue plastic bucket 25 L with plastic handle			1 pc.
8107B	Red plastic bucket 25 L with plastic handle			1 pc.
8332SS	Plastic frame with wheels ø 80 mm for Fred 50 L and Arka trolleys			1 pc.
R8061/1	Rilsan coated push-bar ø 18 mm for Fred trolley			1 pc.

FRED - plastic trolley 30 L with plastic grip



REF.	PCK	VOLUME (m³)	GROSS WEIGHT (kg)	SIZE (cm) ↓ ↓ ↓
7960A/P	1	0,129	7,68	65x41x88
7004A	REGULAR - blue plastic down-press wringer with plastic gears			1 pc.
7963A	Plastic grip for Orion and Fred trolleys			1 pc.
8108A	Blue plastic bucket 15 L with plastic handle			1 pc.
8108B	Red plastic bucket 15 L with plastic handle			1 pc.
8331SS	Plastic frame with wheels ø 80 mm for Fred trolley 30 L			1 pc.

FRED - plastic trolley 50 L with plastic grip



REF.	PCK	VOLUME (m³)	GROSS WEIGHT (kg)	SIZE (cm) ↓ ↓ ↓
7965A/P	1	0,177	8,93	69x42x93
7004A	REGULAR - blue plastic down-press wringer with plastic gears			1 pc.
7963A	Plastic grip for Orion and Fred trolleys			1 pc.
8107A	Blue plastic bucket 25 L with plastic handle			1 pc.
8107B	Red plastic bucket 25 L with plastic handle			1 pc.
8332SS	Plastic frame with wheels ø 80 mm for Fred 50 L and Arka trolleys			1 pc.



BUCKET/WRINGER
COMBOS

PLASTIC MOP
TROLLEYS

CHROMED AND RILSAN
COATED TROLLEYS

WRINGERS

MULTI-PURPOSE
BUCKETS

TOP-DOWN® BUCKETS

OTHER PLASTIC
BUCKETS

FRED - plastic trolley 30 L with plastic grip and basket



REF.	PCK	VOLUME (m³)	GROSS WEIGHT (kg)	SIZE (cm) ↓ ↓ ↓ ↓
03007960A/P	1	0,129	7,95	65x50x88
60402A	Plastic carry basket			1 pc.
7004A	REGULAR - blue plastic down-press wringer with plastic gears			1 pc.
7963A	Plastic grip for Orion and Fred trolleys			1 pc.
8108A	Blue plastic bucket 15 L with plastic handle			1 pc.
8108B	Red plastic bucket 15 L with plastic handle			1 pc.
8331SS	Plastic frame with wheels ø 80 mm for Fred trolley 30 L			1 pc.

FRED - plastic trolley 50 L with plastic grip and basket



REF.	PCK	VOLUME (m³)	GROSS WEIGHT (kg)	SIZE (cm) ↓ ↓ ↓ ↓
03007965A/P	1	0,177	9,2	69x51x93
60402A	Plastic carry basket			1 pc.
7004A	REGULAR - blue plastic down-press wringer with plastic gears			1 pc.
7963A	Plastic grip for Orion and Fred trolleys			1 pc.
8107A	Blue plastic bucket 25 L with plastic handle			1 pc.
8107B	Red plastic bucket 25 L with plastic handle			1 pc.
8332SS	Plastic frame with wheels ø 80 mm for Fred 50 L and Arka trolleys			1 pc.

FRED - plastic trolley 30 L with plastic grip and bag holder



REF.	PCK	VOLUME (m³)	GROSS WEIGHT (kg)	SIZE (cm) ↓ ↓ ↓ ↓
04007960A/P	1	0,129	7,91	65x50x88
7004A	REGULAR - blue plastic down-press wringer with plastic gears			1 pc.
7963A	Plastic grip for Orion and Fred trolleys			1 pc.
8108A	Blue plastic bucket 15 L with plastic handle			1 pc.
8108B	Red plastic bucket 15 L with plastic handle			1 pc.
8331SS	Plastic frame with wheels ø 80 mm for Fred trolley 30 L			1 pc.
P206003A	Plastic bag holder for Orion-Fred-Vega trolleys fitting push-bar art. 7963A and supports art. P290800A - P179002A			1 pc.

FRED - plastic trolley 50 L with plastic grip and bag holder



REF.	PCK	VOLUME (m³)	GROSS WEIGHT (kg)	SIZE (cm) ↓ ↓ ↓ ↓
04007965A/P	1	0,177	9,15	69x51x93
7004A	REGULAR - blue plastic down-press wringer with plastic gears			1 pc.
7963A	Plastic grip for Orion and Fred trolleys			1 pc.
8107A	Blue plastic bucket 25 L with plastic handle			1 pc.
8107B	Red plastic bucket 25 L with plastic handle			1 pc.
8332SS	Plastic frame with wheels ø 80 mm for Fred 50 L and Arka trolleys			1 pc.
P206003A	Plastic bag holder for Orion-Fred-Vega trolleys fitting push-bar art. 7963A and supports art. P290800A - P179002A			1 pc.



PRODUCT PARTIALLY MADE OF PLASTIC COMPONENTS CERTIFIED PSV - PLASTIC SECOND LIFE



BUCKET/WRINGER
COMBOS

PLASTIC MOP
TROLLEYS

CHROMED AND RILSAN
COATED TROLLEYS

WRINGERS

MULTI-PURPOSE
BUCKETS

TOP-DOWN® BUCKETS

OTHER PLASTIC
BUCKETS

Orion trolleys

ORION - plastic trolley 15 L



REF.	PCK	VOLUME (m³)	GROSS WEIGHT (kg)	SIZE (cm) ↓ ↓ ↓
7961A	1	0,138	7,04	53x42x90
60295A				Bucket reduction for Orion trolley 15 L 1 pc.
7004A				REGULAR - blue plastic down-press wringer with plastic gears 1 pc.
8108B				Red plastic bucket 15 L with plastic handle 1 pc.
8335SS				Plastic frame with wheels ø 80 mm for Orion and Vega trolleys 1 pc.

ORION - plastic trolley 25 L



REF.	PCK	VOLUME (m³)	GROSS WEIGHT (kg)	SIZE (cm) ↓ ↓ ↓
7962A	1	0,138	7,09	53x42x90
7004A				REGULAR - blue plastic down-press wringer with plastic gears 1 pc.
8107B				Red plastic bucket 25 L with plastic handle 1 pc.
8335SS				Plastic frame with wheels ø 80 mm for Orion and Vega trolleys 1 pc.

ORION - plastic trolley 15 L



REF.	PCK	VOLUME (m³)	GROSS WEIGHT (kg)	SIZE (cm) ↓ ↓ ↓
7961A/P	1	0,138	7,36	53x42x93
60295A				Bucket reduction for Orion trolley 15 L 1 pc.
7004A				REGULAR - blue plastic down-press wringer with plastic gears 1 pc.
7963A				Plastic grip for Orion and Fred trolleys 1 pc.
8108B				Red plastic bucket 15 L with plastic handle 1 pc.
8335SS				Plastic frame with wheels ø 80 mm for Orion and Vega trolleys 1 pc.

ORION - plastic trolley 25 L



REF.	PCK	VOLUME (m³)	GROSS WEIGHT (kg)	SIZE (cm) ↓ ↓ ↓
7962A/P	1	0,138	7,42	53x42x93
7004A				REGULAR - blue plastic down-press wringer with plastic gears 1 pc.
7963A				Plastic grip for Orion and Fred trolleys 1 pc.
8107B				Red plastic bucket 25 L with plastic handle 1 pc.
8335SS				Plastic frame with wheels ø 80 mm for Orion and Vega trolleys 1 pc.



BUCKET/WRINGER
COMBOS

PLASTIC MOP
TROLLEYS

CHROMED AND RILSAN
COATED TROLLEYS

WRINGERS

MULTI-PURPOSE
BUCKETS

TOP-DOWN® BUCKETS

OTHER PLASTIC
BUCKETS

ORION - plastic trolley 15 L



REF.	PCK	VOLUME (m³)	GROSS WEIGHT (kg)	SIZE (cm) ↓ ↓ ↓
7961A/I	1	0,138	7,63	62x42x90
60295A	Bucket reduction for Orion trolley 15 L			1 pc.
7004A	REGULAR - blue plastic down-press wringer with plastic gears			1 pc.
7966A	Reinforced push-bar for Orion and Vega trolleys			1 pc.
8108B	Red plastic bucket 15 L with plastic handle			1 pc.
8335SS	Plastic frame with wheels ø 80 mm for Orion and Vega trolleys			1 pc.

ORION - plastic trolley 25 L



REF.	PCK	VOLUME (m³)	GROSS WEIGHT (kg)	SIZE (cm) ↓ ↓ ↓
7962A/I	1	0,138	7,68	62x42x90
7004A	REGULAR - blue plastic down-press wringer with plastic gears			1 pc.
7966A	Reinforced push-bar for Orion and Vega trolleys			1 pc.
8107B	Red plastic bucket 25 L with plastic handle			1 pc.
8335SS	Plastic frame with wheels ø 80 mm for Orion and Vega trolleys			1 pc.

Vega trolleys

VEGA LP0302 - plastic trolley 28 L



REF.	PCK	VOLUME (m³)	GROSS WEIGHT (kg)	SIZE (cm) ↓ ↓ ↓
0000LP0302A	1	0,172	8,58	71x42x90
0000SE1128B	Red plastic bucket 28 L with 2 plastic handles and removable divider			1 pc.
0000SM00102U	Hook fitting plastic push-bar art. 7964A - 7966A			1 pc.
7002A	DEEP - plastic side press wringer without bottom			1 pc.
7966A	Reinforced push-bar for Orion and Vega trolleys			1 pc.
8335SS	Plastic frame with wheels ø 80 mm for Orion and Vega trolleys			1 pc.

VEGA LP0304 - plastic trolley 28 L



REF.	PCK	VOLUME (m³)	GROSS WEIGHT (kg)	SIZE (cm) ↓ ↓ ↓
0000LP0304A	1	0,172	8,91	80x42x90
0000SE1128B	Red plastic bucket 28 L with 2 plastic handles and removable divider			1 pc.
0000SM00102U	Hook fitting plastic push-bar art. 7964A - 7966A			1 pc.
7002A	DEEP - plastic side press wringer without bottom			1 pc.
7966A	Reinforced push-bar for Orion and Vega trolleys			1 pc.
8335SS	Plastic frame with wheels ø 80 mm for Orion and Vega trolleys			1 pc.
P206002A	Bagholder 50 L for Vega trolley fitting plastic push-bar art. 7966A			1 pc.



PRODUCT PARTIALLY MADE OF PLASTIC COMPONENTS CERTIFIED PSV - PLASTIC SECOND LIFE

Buckets and wringer trolleys



BUCKET/WRINGER
COMBOS

PLASTIC MOP
TROLLEYS

CHROMED AND RILSAN
COATED TROLLEYS

WRINGERS

MULTI-PURPOSE
BUCKETS

TOP-DOWN® BUCKETS

OTHER PLASTIC
BUCKETS

VEGA LP0308 - plastic trolley 25 L



REF.	PCK	VOLUME (m³)	GROSS WEIGHT (kg)	SIZE (cm) ↓ ↓ ↓
000LP0308A	1	0,131	8,05	71x42x90
0000SM00102U	Hook fitting plastic push-bar art. 7964A - 7966A			1 pc.
7004A	REGULAR - blue plastic down-press wringer with plastic gears			1 pc.
7966A	Reinforced push-bar for Orion and Vega trolleys			1 pc.
8107B	Red plastic bucket 25 L with plastic handle			1 pc.
8335SS	Plastic frame with wheels ø 80 mm for Orion and Vega trolleys			1 pc.
P206002A	Bagholder 50 L for Vega trolley fitting plastic push-bar art. 7966A			1 pc.

VEGA LP0305 - plastic trolley 28 L



REF.	PCK	VOLUME (m³)	GROSS WEIGHT (kg)	SIZE (cm) ↓ ↓ ↓
000LP0305A	1	0,172	9,9	71x42x112
0000SE0104A	Blue plastic bucket 4 L with plastic handle			1 pc.
0000SE0104A	Red plastic bucket 4 L with plastic handle			1 pc.
0000SE1128B	Red plastic bucket 28 L with 2 plastic handles and removable divider			1 pc.
0000SM00102U	Hook fitting plastic push-bar art. 7964A - 7966A			1 pc.
0000SM00110U	FLIP - handle holder suitable for basket art. 60402A and bucket holder art. P220001E			1 pc.
0000SM00215U	Hook fitting plastic basket art. 60402A and plastic bucket support art. P220001E			1 pc.
7002A	DEEP - plastic side press wringer without bottom			1 pc.
7966A	Reinforced push-bar for Orion and Vega trolleys			1 pc.
8335SS	Plastic frame with wheels ø 80 mm for Orion and Vega trolleys			1 pc.
P120004E	Big support for plastic bucket holder art. P220001E			1 pc.
P220001E	Plastic bucket holder complete with supports (small and medium) for Vega and Arka trolleys			1 pc.

VEGA LP0309 - plastic trolley 25 L



REF.	PCK	VOLUME (m³)	GROSS WEIGHT (kg)	SIZE (cm) ↓ ↓ ↓
000LP0309A	1	0,172	9,15	62x42x112
0000SE0104A	Blue plastic bucket 4 L with plastic handle			1 pc.
0000SE0104A	Red plastic bucket 4 L with plastic handle			1 pc.
0000SM00102U	Hook fitting plastic push-bar art. 7964A - 7966A			1 pc.
0000SM00110U	FLIP - handle holder suitable for basket art. 60402A and bucket holder art. P220001E			1 pc.
0000SM00215U	Hook fitting plastic basket art. 60402A and plastic bucket support art. P220001E			1 pc.
7004A	REGULAR - blue plastic down-press wringer with plastic gears			1 pc.
7966A	Reinforced push-bar for Orion and Vega trolleys			1 pc.
8107B	Red plastic bucket 25 L with plastic handle			1 pc.
8335SS	Plastic frame with wheels ø 80 mm for Orion and Vega trolleys			1 pc.
P120004E	Big support for plastic bucket holder art. P220001E			1 pc.
P220001E	Plastic bucket holder complete with supports (small and medium) for Vega and Arka trolleys			1 pc.

VEGA LP0307 - plastic trolley 25 L



REF.	PCK	VOLUME (m³)	GROSS WEIGHT (kg)	SIZE (cm) ↓ ↓ ↓
000LP0307A	1	0,172	9,48	71x42x112
0000SE0104A	Blue plastic bucket 4 L with plastic handle			1 pc.
0000SE0104A	Red plastic bucket 4 L with plastic handle			1 pc.
0000SM00102U	Hook fitting plastic push-bar art. 7964A - 7966A			1 pc.
0000SM00110U	FLIP - handle holder suitable for basket art. 60402A and bucket holder art. P220001E			1 pc.
0000SM00215U	Hook fitting plastic basket art. 60402A and plastic bucket support art. P220001E			1 pc.
7004A	REGULAR - blue plastic down-press wringer with plastic gears			1 pc.
7966A	Reinforced push-bar for Orion and Vega trolleys			1 pc.
8107B	Red plastic bucket 25 L with plastic handle			1 pc.
8335SS	Plastic frame with wheels ø 80 mm for Orion and Vega trolleys			1 pc.
P206002A	Bagholder 50 L for Vega trolley fitting plastic push-bar art. 7966A			1 pc.
P220001E	Plastic bucket holder complete with supports (small and medium) for Vega and Arka trolleys			1 pc.



PRODUCT PARTIALLY MADE OF PLASTIC COMPONENTS CERTIFIED PSV - PLASTIC SECOND LIFE

BUCKETS AND
WRINGER TROLLEYS

BUCKET/WRINGER
COMBOS

PLASTIC MOP
TROLLEYS

CHROMED AND RILSAN
COATED TROLLEYS

WRINGERS

MULTI-PURPOSE
BUCKETS

TOP-DOWN® BUCKETS

OTHER PLASTIC
BUCKETS

VEGA 22LP0303 - plastic trolley 28 L



REF.	PCK	VOLUME (m³)	GROSS WEIGHT (kg)	SIZE (cm) ↓ ↓ ↓
0022LP0303A	1	0,172	11,03	80x42x112
0000SE0104A	Blue plastic bucket 4 L with plastic handle			1 pc.
0000SE0104A	Red plastic bucket 4 L with plastic handle			1 pc.
0000SE1128B	Red plastic bucket 28 L with 2 plastic handles and removable divider			1 pc.
0000SM00102U	Hook fitting plastic push-bar art. 7964A - 7966A			1 pc.
0000SM00110U	FLIP - handle holder suitable for basket art. 60402A and bucket holder art. P220001E			1 pc.
0000SM00215U	Hook fitting plastic basket art. 60402A and plastic bucket support art. P220001E			1 pc.
14000A	PUNTO - plastic roll wringer central position, blue			1 pc.
7966A	Reinforced push-bar for Orion and Vega trolleys			1 pc.
8335SS	Plastic frame with wheels ø 80 mm for Orion and Vega trolleys			1 pc.
P206002A	Bagholder 50 L for Vega trolley fitting plastic push-bar art. 7966A			1 pc.
P220001E	Plastic bucket holder complete with supports (small and medium) for Vega and Arka trolleys			1 pc.

VEGA LP0303 - plastic trolley 28 L



REF.	PCK	VOLUME (m³)	GROSS WEIGHT (kg)	SIZE (cm) ↓ ↓ ↓
0000LP0303A	1	0,172	9,7	80x42x112
0000SE0104A	Blue plastic bucket 4 L with plastic handle			1 pc.
0000SE0104A	Red plastic bucket 4 L with plastic handle			1 pc.
0000SE1128B	Red plastic bucket 28 L with 2 plastic handles and removable divider			1 pc.
0000SM00102U	Hook fitting plastic push-bar art. 7964A - 7966A			1 pc.
0000SM00110U	FLIP - handle holder suitable for basket art. 60402A and bucket holder art. P220001E			1 pc.
0000SM00215U	Hook fitting plastic basket art. 60402A and plastic bucket support art. P220001E			1 pc.
7002A	DEEP - plastic side press wringer without bottom			1 pc.
7966A	Reinforced push-bar for Orion and Vega trolleys			1 pc.
8335SS	Plastic frame with wheels ø 80 mm for Orion and Vega trolleys			1 pc.
P206002A	Bagholder 50 L for Vega trolley fitting plastic push-bar art. 7966A			1 pc.
P220001E	Plastic bucket holder complete with supports (small and medium) for Vega and Arka trolleys			1 pc.



BUCKET/WRINGER
COMBOS

PLASTIC MOP
TROLLEYS

CHROMED AND RILSAN
COATED TROLLEYS

WRINGERS

MULTI-PURPOSE
BUCKETS

TOP-DOWN® BUCKETS

OTHER PLASTIC
BUCKETS

Arka trolleys

ARKA 10 - plastic trolley 28 L



REF.	PCK	VOLUME (m³)	GROSS WEIGHT (kg)	SIZE (cm) ↓ ↓ ↓
0006LP1280A	1	0,211	11,73	55x107x92
0000SE1128B	Red plastic bucket 28 L with 2 plastic handles and removable divider			1 pc.
7002A	DEEP - plastic side press wringer without bottom			1 pc.
7964A	Reinforced plastic push-bar for Arka trolley			1 pc.
8332SS	Plastic frame with wheels ø 80 mm for Fred 50 L and Arka trolleys			1 pc.
P114011A	Supporting plastic plate for Arka trolley			1 pc.
P281001E	Set of two grey pushing grips (right and left) with reinforcements (right and left) and fixing screws for Arka trolley			1 pc.
P306010A	Plastic bagholder 100 L with bag-stretchers and cover with chek-list holder for Arka trolley			1 pc.

ON REQUEST, WITH SURCHARGE

with 2 wheels 80 mm + 2 axial wheels 200 mm



TROLLEY REF.
0006LP2280A

ARKA 11 - plastic trolley 28 L



REF.	PCK	VOLUME (m³)	GROSS WEIGHT (kg)	SIZE (cm) ↓ ↓ ↓
0006LP1281A	1	0,211	13	55x107x111
0000SE0104A	Blue plastic bucket 4 L with plastic handle			1 pc.
0000SE0104A	Red plastic bucket 4 L with plastic handle			1 pc.
0000SE1128B	Red plastic bucket 28 L with 2 plastic handles and removable divider			1 pc.
0000SM00110U	FLIP - handle holder suitable for basket art. 60402A and bucket holder art. P220001E			1 pc.
0000SM00215U	Hook fitting plastic basket art. 60402A and plastic bucket support art. P220001E			1 pc.
7002A	DEEP - plastic side press wringer without bottom			1 pc.
7964A	Reinforced plastic push-bar for Arka trolley			1 pc.
8332SS	Plastic frame with wheels ø 80 mm for Fred 50 L and Arka trolleys			1 pc.
P114011A	Supporting plastic plate for Arka trolley			1 pc.
P120004E	Big support for plastic bucket holder art. P220001E			1 pc.
P220001E	Plastic bucket holder complete with supports (small and medium) for Vega and Arka trolleys			1 pc.
P281001E	Set of two grey pushing grips (right and left) with reinforcements (right and left) and fixing screws for Arka trolley			1 pc.
P306010A	Plastic bagholder 100 L with bag-stretchers and cover with chek-list holder for Arka trolley			1 pc.

ON REQUEST, WITH SURCHARGE

with 2 wheels 80 mm + 2 axial wheels 200 mm



TROLLEY REF.
0006LP2281A



ARKA 12 - plastic trolley 28 L



REF.	PCK	VOLUME (m³)	GROSS WEIGHT (kg)	SIZE (cm) ↓ ↓ ↓
0006LP1282A	1	0,211	13,55	60x107x111
0000SE0104A				Blue plastic bucket 4 L with plastic handle 1 pc.
0000SE0104A				Red plastic bucket 4 L with plastic handle 1 pc.
0000SE1128B				Red plastic bucket 28 L with 2 plastic handles and removable divider 1 pc.
0000SM00110U				FLIP - handle holder suitable for basket art. 60402A and bucket holder art. P220001E 1 pc.
0000SM00215U				Hook fitting plastic basket art. 60402A and plastic bucket support art. P220001E 1 pc.
7002A				DEEP - plastic side press wringer without bottom 1 pc.
7964A				Reinforced plastic push-bar for Arka trolley 1 pc.
8332SS				Plastic frame with wheels ø 80 mm for Fred 50 L and Arka trolleys 1 pc.
P114011A				Supporting plastic plate for Arka trolley 1 pc.
P120004E				Big support for plastic bucket holder art. P220001E 1 pc.
P220001E				Plastic bucket holder complete with supports (small and medium) for Vega and Arka trolleys 1 pc.
P224002E				Plastic basket or bucket holder complete with supports for Vega and Arka trolleys 1 pc.
P281001E				Set of two grey pushing grips (right and left) with reinforcements (right and left) and fixing screws for Arka trolley 1 pc.
P306010A				Plastic bagholder 100 L with bag-stretchers and cover with chek-list holder for Arka trolley 1 pc.

ON REQUEST, WITH SURCHARGE

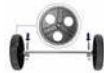

with 2 wheels 80 mm + 2 axial wheels 200 mm

TROLLEY REF.
0006LP2282A

ARKA 13 - plastic trolley 28 L



REF.	PCK	VOLUME (m³)	GROSS WEIGHT (kg)	SIZE (cm) ↓ ↓ ↓
0006LP1283A	1	0,211	13,97	65x107x111
0000SE0104A				Blue plastic bucket 4 L with plastic handle 1 pc.
0000SE0104A				Red plastic bucket 4 L with plastic handle 1 pc.
0000SE1128B				Red plastic bucket 28 L with 2 plastic handles and removable divider 1 pc.
0000SM00110U				FLIP - handle holder suitable for basket art. 60402A and bucket holder art. P220001E 1 pc.
0000SM00215U				Hook fitting plastic basket art. 60402A and plastic bucket support art. P220001E 1 pc.
7002A				DEEP - plastic side press wringer without bottom 1 pc.
7964A				Reinforced plastic push-bar for Arka trolley 1 pc.
8332SS				Plastic frame with wheels ø 80 mm for Fred 50 L and Arka trolleys 1 pc.
P114011A				Supporting plastic plate for Arka trolley 1 pc.
P120004E				Big support for plastic bucket holder art. P220001E 1 pc.
P220001E				Plastic bucket holder complete with supports (small and medium) for Vega and Arka trolleys 1 pc.
P224002E				Plastic basket or bucket holder complete with supports for Vega and Arka trolleys 1 pc.
P225004A				Set of plastic paper holder with cover complete with 3 hooks 1 pc.
P281001E				Set of two grey pushing grips (right and left) with reinforcements (right and left) and fixing screws for Arka trolley 1 pc.
P306010A				Plastic bagholder 100 L with bag-stretchers and cover with chek-list holder for Arka trolley 1 pc.

ON REQUEST, WITH SURCHARGE

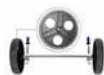

with 2 wheels 80 mm + 2 axial wheels 200 mm

TROLLEY REF.
0006LP2283A

Buckets and wringer trolleys



BUCKET/WRINGER
COMBOS

PLASTIC MOP
TROLLEYS

CHROMED AND RILSAN
COATED TROLLEYS

WRINGERS

MULTI-PURPOSE
BUCKETS

TOP-DOWN® BUCKETS

OTHER PLASTIC
BUCKETS

ARKA 14 - plastic trolley 28 L



REF.	PCK	VOLUME (m³)	GROSS WEIGHT (kg)	SIZE (cm) ↓ ↓ ↓
0006LP1284A	1	0,211	14,59	65x107x111
0000SE0104A	Blue plastic bucket 4 L with plastic handle			1 pc.
0000SE104A	Red plastic bucket 4 L with plastic handle			1 pc.
0000SE1128B	Red plastic bucket 28 L with 2 plastic handles and removable divider			1 pc.
0000SM00110U	FLIP - handle holder suitable for basket art. 60402A and bucket holder art. P220001E			1 pc.
0000SM00215U	Hook fitting plastic basket art. 60402A and plastic bucket support art. P220001E			1 pc.
7002A	DEEP - plastic side press wringer without bottom			1 pc.
7964A	Reinforced plastic push-bar for Arka trolley			1 pc.
8332SS	Plastic frame with wheels ø 80 mm for Fred 50 L and Arka trolleys			1 pc.
P114011A	Supporting plastic plate for Arka trolley			1 pc.
P120004E	Big support for plastic bucket holder art. P220001E			1 pc.
P120007A	Plastic quiver for polybags			1 pc.
P220001E	Plastic bucket holder complete with supports (small and medium) for Vega and Arka trolleys			1 pc.
P224002E	Plastic basket or bucket holder complete with supports for Vega and Arka trolleys			1 pc.
P225004A	Set of plastic paper holder with cover complete with 3 hooks			1 pc.
P281001E	Set of two grey pushing grips (right and left) with reinforcements (right and left) and fixing screws for Arka trolley			1 pc.
P306010A	Plastic bagholder 100 L with bag-stretchers and cover with chek-list holder for Arka trolley			1 pc.

ON REQUEST, WITH SURCHARGE



with 2 wheels 80 mm + 2 axial wheels 200 mm

TROLLEY REF.
0006LP2284A

ARKA 15 - plastic trolley 28 L



REF.	PCK	VOLUME (m³)	GROSS WEIGHT (kg)	SIZE (cm) ↓ ↓ ↓
0006LP1285A	1	0,211	14,82	65x107x111
0000SE0104A	Blue plastic bucket 4 L with plastic handle			1 pc.
0000SE104A	Red plastic bucket 4 L with plastic handle			1 pc.
0000SE1128B	Red plastic bucket 28 L with 2 plastic handles and removable divider			1 pc.
0000SM00110U	FLIP - handle holder suitable for basket art. 60402A and bucket holder art. P220001E			1 pc.
0000SM00215U	Hook fitting plastic basket art. 60402A and plastic bucket support art. P220001E			1 pc.
7002A	DEEP - plastic side press wringer without bottom			1 pc.
7964A	Reinforced plastic push-bar for Arka trolley			1 pc.
8332SS	Plastic frame with wheels ø 80 mm for Fred 50 L and Arka trolleys			1 pc.
P114011A	Supporting plastic plate for Arka trolley			1 pc.
P120004E	Big support for plastic bucket holder art. P220001E			1 pc.
P120007A	Plastic quiver for polybags			1 pc.
P120008A	Plastic quiver for window squeegees, washers, scrapers			1 pc.
P220001E	Plastic bucket holder complete with supports (small and medium) for Vega and Arka trolleys			1 pc.
P224002E	Plastic basket or bucket holder complete with supports for Vega and Arka trolleys			1 pc.
P225004A	Set of plastic paper holder with cover complete with 3 hooks			1 pc.
P281001E	Set of two grey pushing grips (right and left) with reinforcements (right and left) and fixing screws for Arka trolley			1 pc.
P306010A	Plastic bagholder 100 L with bag-stretchers and cover with chek-list holder for Arka trolley			1 pc.

ON REQUEST, WITH SURCHARGE



with 2 wheels 80 mm + 2 axial wheels 200 mm

TROLLEY REF.
0006LP2285A

BUCKETS AND
WRINGER TROLLEYS



PRODUCT PARTIALLY MADE OF PLASTIC COMPONENTS CERTIFIED PSV - PLASTIC SECOND LIFE

BUCKET/WRINGER
COMBOS

PLASTIC MOP
TROLLEYS

CHROMED AND RILSAN
COATED TROLLEYS

WRINGERS

MULTI-PURPOSE
BUCKETS

TOP-DOWN® BUCKETS

OTHER PLASTIC
BUCKETS

ARKA 20 - plastic trolley 28 L



REF.	PCK	VOLUME (m³)	GROSS WEIGHT (kg)	SIZE (cm) ↓ ↓ ↓
0022LP1280A	1	0,211	12,53	55x107x92
0000SE1128B	Red plastic bucket 28 L with 2 plastic handles and removable divider			1 pc.
14000A	PUNTO - plastic roll wringer central position, blue			1 pc.
7964A	Reinforced plastic push-bar for Arka trolley			1 pc.
8332SS	Plastic frame with wheels ø 80 mm for Fred 50 L and Arka trolleys			1 pc.
P114011A	Supporting plastic plate for Arka trolley			1 pc.
P281001E	Set of two grey pushing grips (right and left) with reinforcements (right and left) and fixing screws for Arka trolley			1 pc.
P306010A	Plastic bagholder 100 L with bag-stretchers and cover with chek-list holder for Arka trolley			1 pc.

ON REQUEST, WITH SURCHARGE

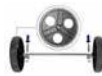

with 2 wheels 80 mm + 2 axial wheels 200 mm

TROLLEY REF.
0022LP2280A

ARKA 21 - plastic trolley 28 L



REF.	PCK	VOLUME (m³)	GROSS WEIGHT (kg)	SIZE (cm) ↓ ↓ ↓
0022LP1281A	1	0,211	13,8	56x107x111
0000SE0104A	Blue plastic bucket 4 L with plastic handle			1 pc.
0000SE0104A	Red plastic bucket 4 L with plastic handle			1 pc.
0000SE1128B	Red plastic bucket 28 L with 2 plastic handles and removable divider			1 pc.
0000SM00110U	FLIP - handle holder suitable for basket art. 60402A and bucket holder art. P220001E			1 pc.
0000SM00215U	Hook fitting plastic basket art. 60402A and plastic bucket support art. P220001E			1 pc.
14000A	PUNTO - plastic roll wringer central position, blue			1 pc.
7964A	Reinforced plastic push-bar for Arka trolley			1 pc.
8332SS	Plastic frame with wheels ø 80 mm for Fred 50 L and Arka trolleys			1 pc.
P114011A	Supporting plastic plate for Arka trolley			1 pc.
P120004E	Big support for plastic bucket holder art. P220001E			1 pc.
P220001E	Plastic bucket holder complete with supports (small and medium) for Vega and Arka trolleys			1 pc.
P281001E	Set of two grey pushing grips (right and left) with reinforcements (right and left) and fixing screws for Arka trolley			1 pc.
P306010A	Plastic bagholder 100 L with bag-stretchers and cover with chek-list holder for Arka trolley			1 pc.

ON REQUEST, WITH SURCHARGE



with 2 wheels 80 mm + 2 axial wheels 200 mm

TROLLEY REF.
0022LP2281A

Buckets and wringer trolleys



BUCKET/WRINGER
COMBOS

PLASTIC MOP
TROLLEYS

CHROMED AND RILSAN
COATED TROLLEYS

WRINGERS

MULTI-PURPOSE
BUCKETS

TOP-DOWN® BUCKETS

OTHER PLASTIC
BUCKETS

ARKA 22 - plastic trolley 28 L



REF.	PCK	VOLUME (m³)	GROSS WEIGHT (kg)	SIZE (cm) ↓ ↓ ↓
0022LP1282A	1	0,211	14,35	60x107x111
0000SE0104A	Blue plastic bucket 4 L with plastic handle			1 pc.
0000SE0104A	Red plastic bucket 4 L with plastic handle			1 pc.
0000SE1128B	Red plastic bucket 28 L with 2 plastic handles and removable divider			1 pc.
0000SM00110U	FLIP - handle holder suitable for basket art. 60402A and bucket holder art. P220001E			1 pc.
0000SM00215U	Hook fitting plastic basket art. 60402A and plastic bucket support art. P220001E			1 pc.
14000A	PUNTO - plastic roll wringer central position, blue			1 pc.
7964A	Reinforced plastic push-bar for Arka trolley			1 pc.
8332SS	Plastic frame with wheels ø 80 mm for Fred 50 L and Arka trolleys			1 pc.
P114011A	Supporting plastic plate for Arka trolley			1 pc.
P120004E	Big support for plastic bucket holder art. P220001E			1 pc.
P220001E	Plastic bucket holder complete with supports (small and medium) for Vega and Arka trolleys			1 pc.
P224002E	Plastic basket or bucket holder complete with supports for Vega and Arka trolleys			1 pc.
P281001E	Set of two grey pushing grips (right and left) with reinforcements (right and left) and fixing screws for Arka trolley			1 pc.
P306010A	Plastic bagholder 100 L with bag-stretchers and cover with chek-list holder for Arka trolley			1 pc.

ON REQUEST, WITH SURCHARGE

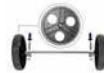

with 2 wheels 80 mm + 2 axial wheels 200 mm

TROLLEY REF.
0022LP2282A

ARKA 23 - plastic trolley 28 L



REF.	PCK	VOLUME (m³)	GROSS WEIGHT (kg)	SIZE (cm) ↓ ↓ ↓
0022LP1283A	1	0,211	14,77	65x107x111
0000SE0104A	Blue plastic bucket 4 L with plastic handle			1 pc.
0000SE0104A	Red plastic bucket 4 L with plastic handle			1 pc.
0000SE1128B	Red plastic bucket 28 L with 2 plastic handles and removable divider			1 pc.
0000SM00110U	FLIP - handle holder suitable for basket art. 60402A and bucket holder art. P220001E			1 pc.
0000SM00215U	Hook fitting plastic basket art. 60402A and plastic bucket support art. P220001E			1 pc.
14000A	PUNTO - plastic roll wringer central position, blue			1 pc.
7964A	Reinforced plastic push-bar for Arka trolley			1 pc.
8332SS	Plastic frame with wheels ø 80 mm for Fred 50 L and Arka trolleys			1 pc.
P114011A	Supporting plastic plate for Arka trolley			1 pc.
P120004E	Big support for plastic bucket holder art. P220001E			1 pc.
P220001E	Plastic bucket holder complete with supports (small and medium) for Vega and Arka trolleys			1 pc.
P224002E	Plastic basket or bucket holder complete with supports for Vega and Arka trolleys			1 pc.
P225004A	Set of plastic paper holder with cover complete with 3 hooks			1 pc.
P281001E	Set of two grey pushing grips (right and left) with reinforcements (right and left) and fixing screws for Arka trolley			1 pc.
P306010A	Plastic bagholder 100 L with bag-stretchers and cover with chek-list holder for Arka trolley			1 pc.

ON REQUEST, WITH SURCHARGE



with 2 wheels 80 mm + 2 axial wheels 200 mm

TROLLEY REF.
0022LP2283A

BUCKETS AND
WRINGER TROLLEYS



PRODUCT PARTIALLY MADE OF PLASTIC COMPONENTS CERTIFIED PSV - PLASTIC SECOND LIFE

ARKA 24 - plastic trolley 28 L

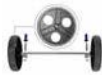

REF.	PCK	VOLUME (m³)	GROSS WEIGHT (kg)	SIZE (cm) ↓ ↓ ↓
0022LP1284A	1	0,211	14,73	65x107x111
0000SE0104A	Blue plastic bucket 4 L with plastic handle			1 pc.
0000SE104A	Red plastic bucket 4 L with plastic handle			1 pc.
0000SE1128B	Red plastic bucket 28 L with 2 plastic handles and removable divider			1 pc.
0000SM00110U	FLIP - handle holder suitable for basket art. 60402A and bucket holder art. P220001E			1 pc.
0000SM00215U	Hook fitting plastic basket art. 60402A and plastic bucket support art. P220001E			1 pc.
14000A	PUNTO - plastic roll wringer central position, blue			1 pc.
7964A	Reinforced plastic push-bar for Arka trolley			1 pc.
8332SS	Plastic frame with wheels ø 80 mm for Fred 50 L and Arka trolleys			1 pc.
P114011A	Supporting plastic plate for Arka trolley			1 pc.
P120004E	Big support for plastic bucket holder art. P220001E			1 pc.
P120007A	Plastic quiver for polybags			1 pc.
P220001E	Plastic bucket holder complete with supports (small and medium) for Vega and Arka trolleys			1 pc.
P224002E	Plastic basket or bucket holder complete with supports for Vega and Arka trolleys			1 pc.
P225004A	Set of plastic paper holder with cover complete with 3 hooks			1 pc.
P281001E	Set of two grey pushing grips (right and left) with reinforcements (right and left) and fixing screws for Arka trolley			1 pc.
P306010A	Plastic bagholder 100 L with bag-stretchers and cover with chek-list holder for Arka trolley			1 pc.

ON REQUEST, WITH SURCHARGE

with 2 wheels 80 mm + 2 axial wheels 200 mm

**TROLLEY REF.
0022LP2284A**
ARKA 25 - plastic trolley 28 L

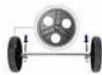
REF.	PCK	VOLUME (m³)	GROSS WEIGHT (kg)	SIZE (cm) ↓ ↓ ↓
0022LP1285A	1	0,211	14,96	65x107x111
0000SE0104A	Blue plastic bucket 4 L with plastic handle			1 pc.
0000SE104A	Red plastic bucket 4 L with plastic handle			1 pc.
0000SE1128B	Red plastic bucket 28 L with 2 plastic handles and removable divider			1 pc.
0000SM00110U	FLIP - handle holder suitable for basket art. 60402A and bucket holder art. P220001E			1 pc.
0000SM00215U	Hook fitting plastic basket art. 60402A and plastic bucket support art. P220001E			1 pc.
14000A	PUNTO - plastic roll wringer central position, blue			1 pc.
7964A	Reinforced plastic push-bar for Arka trolley			1 pc.
8332SS	Plastic frame with wheels ø 80 mm for Fred 50 L and Arka trolleys			1 pc.
P114011A	Supporting plastic plate for Arka trolley			1 pc.
P120004E	Big support for plastic bucket holder art. P220001E			1 pc.
P120007A	Plastic quiver for polybags			1 pc.
P120008A	Plastic quiver for window squeegees, washers, scrapers			1 pc.
P220001E	Plastic bucket holder complete with supports (small and medium) for Vega and Arka trolleys			1 pc.
P224002E	Plastic basket or bucket holder complete with supports for Vega and Arka trolleys			1 pc.
P225004A	Set of plastic paper holder with cover complete with 3 hooks			1 pc.
P281001E	Set of two grey pushing grips (right and left) with reinforcements (right and left) and fixing screws for Arka trolley			1 pc.
P306010A	Plastic bagholder 100 L with bag-stretchers and cover with chek-list holder for Arka trolley			1 pc.

ON REQUEST, WITH SURCHARGE

with 2 wheels 80 mm + 2 axial wheels 200 mm

**TROLLEY REF.
0022LP2285A**

Buckets and wringer trolleys



BUCKET/WRINGER
COMBOS

PLASTIC MOP
TROLLEYS

CHROMED AND RILSAN
COATED TROLLEYS

WRINGERS

MULTI-PURPOSE
BUCKETS

TOP-DOWN® BUCKETS

OTHER PLASTIC
BUCKETS

ARKA 30 - plastic trolley 28 L



REF.	PCK	VOLUME (m³)	GROSS WEIGHT (kg)	SIZE (cm) ↓ ↓ ↓
0005LP1250A	1	0,211	11,35	55x99x92
7004A	REGULAR - blue plastic down-press wringer with plastic gears			1 pc.
7964A	Reinforced plastic push-bar for Arka trolley			1 pc.
8107B	Red plastic bucket 25 L with plastic handle			1 pc.
8332SS	Plastic frame with wheels ø 80 mm for Fred 50 L and Arka trolleys			1 pc.
P114011A	Supporting plastic plate for Arka trolley			1 pc.
P281001E	Set of two grey pushing grips (right and left) with reinforcements (right and left) and fixing screws for Arka trolley			1 pc.
P306010A	Plastic bagholder 100 L with bag-stretchers and cover with chek-list holder for Arka trolley			1 pc.

ON REQUEST, WITH SURCHARGE



with 2 wheels 80 mm + 2 axial wheels 200 mm

TROLLEY REF.
0005LP2250A

ARKA 31 - plastic trolley 28 L



REF.	PCK	VOLUME (m³)	GROSS WEIGHT (kg)	SIZE (cm) ↓ ↓ ↓
0005LP1251A	1	0,211	12,62	56x99x111
0000SE0104A	Blue plastic bucket 4 L with plastic handle			1 pc.
0000SE0104A	Red plastic bucket 4 L with plastic handle			1 pc.
0000SM00110U	FLIP - handle holder suitable for basket art. 60402A and bucket holder art. P220001E			1 pc.
0000SM00215U	Hook fitting plastic basket art. 60402A and plastic bucket support art. P220001E			1 pc.
7004A	REGULAR - blue plastic down-press wringer with plastic gears			1 pc.
7964A	Reinforced plastic push-bar for Arka trolley			1 pc.
8107B	Red plastic bucket 25 L with plastic handle			1 pc.
8332SS	Plastic frame with wheels ø 80 mm for Fred 50 L and Arka trolleys			1 pc.
P114011A	Supporting plastic plate for Arka trolley			1 pc.
P120004E	Big support for plastic bucket holder art. P220001E			1 pc.
P220001E	Plastic bucket holder complete with supports (small and medium) for Vega and Arka trolleys			1 pc.
P281001E	Set of two grey pushing grips (right and left) with reinforcements (right and left) and fixing screws for Arka trolley			1 pc.
P306010A	Plastic bagholder 100 L with bag-stretchers and cover with chek-list holder for Arka trolley			1 pc.

ON REQUEST, WITH SURCHARGE



with 2 wheels 80 mm + 2 axial wheels 200 mm

TROLLEY REF.
0005LP2251A

BUCKETS AND
WRINGER TROLLEYS



PRODUCT PARTIALLY MADE OF PLASTIC COMPONENTS CERTIFIED PSV - PLASTIC SECOND LIFE

ARKA 32 - plastic trolley 28 L



REF.	PCK	VOLUME (m³)	GROSS WEIGHT (kg)	SIZE (cm) ↓ ↓ ↓
0005LP1252A	1	0,211	13,17	60x90x111
0000SE0104A	Blue plastic bucket 4 L with plastic handle			1 pc.
0000SE0104A	Red plastic bucket 4 L with plastic handle			1 pc.
0000SM00110U	FLIP - handle holder suitable for basket art. 60402A and bucket holder art. P220001E			1 pc.
0000SM00215U	Hook fitting plastic basket art. 60402A and plastic bucket support art. P220001E			1 pc.
7004A	REGULAR - blue plastic down-press wringer with plastic gears			1 pc.
7964A	Reinforced plastic push-bar for Arka trolley			1 pc.
8107B	Red plastic bucket 25 L with plastic handle			1 pc.
8332SS	Plastic frame with wheels ø 80 mm for Fred 50 L and Arka trolleys			1 pc.
P114011A	Supporting plastic plate for Arka trolley			1 pc.
P120004E	Big support for plastic bucket holder art. P220001E			1 pc.
P220001E	Plastic bucket holder complete with supports (small and medium) for Vega and Arka trolleys			1 pc.
P224002E	Plastic basket or bucket holder complete with supports for Vega and Arka trolleys			1 pc.
P281001E	Set of two grey pushing grips (right and left) with reinforcements (right and left) and fixing screws for Arka trolley			1 pc.
P306010A	Plastic bagholder 100 L with bag-stretchers and cover with chek-list holder for Arka trolley			1 pc.

ON REQUEST, WITH SURCHARGE

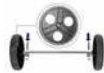

with 2 wheels 80 mm + 2 axial wheels 200 mm

TROLLEY REF.
0005LP2252A

ARKA 33 - plastic trolley 28 L



REF.	PCK	VOLUME (m³)	GROSS WEIGHT (kg)	SIZE (cm) ↓ ↓ ↓
0005LP1253A	1	0,211	13,59	65x99x111
0000SE0104A	Blue plastic bucket 4 L with plastic handle			1 pc.
0000SE0104A	Red plastic bucket 4 L with plastic handle			1 pc.
0000SM00110U	FLIP - handle holder suitable for basket art. 60402A and bucket holder art. P220001E			1 pc.
0000SM00215U	Hook fitting plastic basket art. 60402A and plastic bucket support art. P220001E			1 pc.
7004A	REGULAR - blue plastic down-press wringer with plastic gears			1 pc.
7964A	Reinforced plastic push-bar for Arka trolley			1 pc.
8107B	Red plastic bucket 25 L with plastic handle			1 pc.
8332SS	Plastic frame with wheels ø 80 mm for Fred 50 L and Arka trolleys			1 pc.
P114011A	Supporting plastic plate for Arka trolley			1 pc.
P120004E	Big support for plastic bucket holder art. P220001E			1 pc.
P220001E	Plastic bucket holder complete with supports (small and medium) for Vega and Arka trolleys			1 pc.
P224002E	Plastic basket or bucket holder complete with supports for Vega and Arka trolleys			1 pc.
P225004A	Set of plastic paper holder with cover complete with 3 hooks			1 pc.
P281001E	Set of two grey pushing grips (right and left) with reinforcements (right and left) and fixing screws for Arka trolley			1 pc.
P306010A	Plastic bagholder 100 L with bag-stretchers and cover with chek-list holder for Arka trolley			1 pc.

ON REQUEST, WITH SURCHARGE



with 2 wheels 80 mm + 2 axial wheels 200 mm

TROLLEY REF.
0005LP2253A

Buckets and wringer trolleys



BUCKET/WRINGER
COMBOS

PLASTIC MOP
TROLLEYS

CHROMED AND RILSAN
COATED TROLLEYS

WRINGERS

MULTI-PURPOSE
BUCKETS

TOP-DOWN® BUCKETS

OTHER PLASTIC
BUCKETS

ARKA 34 - plastic trolley 28 L



REF.	PCK	VOLUME (m³)	GROSS WEIGHT (kg)	SIZE (cm) ↓ ↓ ↓
0005LP1254A	1	0,211	13,88	65x99x111
0000SE0104A	Blue plastic bucket 4 L with plastic handle			1 pc.
0000SE0104A	Red plastic bucket 4 L with plastic handle			1 pc.
0000SM00110U	FLIP - handle holder suitable for basket art. 60402A and bucket holder art. P220001E			1 pc.
0000SM00215U	Hook fitting plastic basket art. 60402A and plastic bucket support art. P220001E			1 pc.
7004A	REGULAR - blue plastic down-press wringer with plastic gears			1 pc.
7964A	Reinforced plastic push-bar for Arka trolley			1 pc.
8107B	Red plastic bucket 25 L with plastic handle			1 pc.
8332SS	Plastic frame with wheels ø 80 mm for Fred 50 L and Arka trolleys			1 pc.
P114011A	Supporting plastic plate for Arka trolley			1 pc.
P120004E	Big support for plastic bucket holder art. P220001E			1 pc.
P120007A	Plastic quiver for polybags			1 pc.
P220001E	Plastic bucket holder complete with supports (small and medium) for Vega and Arka trolleys			1 pc.
P224002E	Plastic basket or bucket holder complete with supports for Vega and Arka trolleys			1 pc.
P225004A	Set of plastic paper holder with cover complete with 3 hooks			1 pc.
P281001E	Set of two grey pushing grips (right and left) with reinforcements (right and left) and fixing screws for Arka trolley			1 pc.
P306010A	Plastic bagholder 100 L with bag-stretchers and cover with chek-list holder for Arka trolley			1 pc.

ON REQUEST, WITH SURCHARGE



with 2 wheels 80 mm + 2 axial wheels 200 mm

TROLLEY REF.
0005LP2254A

ARKA 35 - plastic trolley 28 L



REF.	PCK	VOLUME (m³)	GROSS WEIGHT (kg)	SIZE (cm) ↓ ↓ ↓
0005LP1255A	1	0,211	14,11	65x99x111
0000SE0104A	Blue plastic bucket 4 L with plastic handle			1 pc.
0000SE0104A	Red plastic bucket 4 L with plastic handle			1 pc.
0000SM00110U	FLIP - handle holder suitable for basket art. 60402A and bucket holder art. P220001E			1 pc.
0000SM00215U	Hook fitting plastic basket art. 60402A and plastic bucket support art. P220001E			1 pc.
7004A	REGULAR - blue plastic down-press wringer with plastic gears			1 pc.
7964A	Reinforced plastic push-bar for Arka trolley			1 pc.
8107B	Red plastic bucket 25 L with plastic handle			1 pc.
8332SS	Plastic frame with wheels ø 80 mm for Fred 50 L and Arka trolleys			1 pc.
P114011A	Supporting plastic plate for Arka trolley			1 pc.
P120004E	Big support for plastic bucket holder art. P220001E			1 pc.
P120007A	Plastic quiver for polybags			1 pc.
P120008A	Plastic quiver for window squeegees, washers, scrapers			1 pc.
P220001E	Plastic bucket holder complete with supports (small and medium) for Vega and Arka trolleys			1 pc.
P224002E	Plastic basket or bucket holder complete with supports for Vega and Arka trolleys			1 pc.
P225004A	Set of plastic paper holder with cover complete with 3 hooks			1 pc.
P281001E	Set of two grey pushing grips (right and left) with reinforcements (right and left) and fixing screws for Arka trolley			1 pc.
P306010A	Plastic bagholder 100 L with bag-stretchers and cover with chek-list holder for Arka trolley			1 pc.

ON REQUEST, WITH SURCHARGE



with 2 wheels 80 mm + 2 axial wheels 200 mm

TROLLEY REF.
0005LP2255A

BUCKETS AND
WRINGER TROLLEYS



PRODUCT PARTIALLY MADE OF PLASTIC COMPONENTS CERTIFIED PSV - PLASTIC SECOND LIFE

Vega and Arka Top-Down® trolleys

VEGA TOP-DOWN® - plastic trolley



REF.	PCK	VOLUME (m³)	GROSS WEIGHT (kg)	SIZE (cm) ↓ ↓ ↓
000LP0321A2	1	0,261	12,19	88x59x112
0000SE0104A	Blue plastic bucket 4 L with plastic handle			1 pc.
0000SE0104A	Red plastic bucket 4 L with plastic handle			1 pc.
0000SE1322A	TOP-DOWN® - blue plastic bucket 20 L with plastic handle and hermetic cover			1 pc.
0000SE1322B	TOP-DOWN® - red plastic bucket 20 L with plastic handle and hermetic cover			1 pc.
0000SM00102U	Hook fitting plastic push-bar art. 7964A - 7966A			1 pc.
0000SM00110U	FLIP - handle holder suitable for basket art. 60402A and bucket holder art. P220001E			1 pc.
0000SM00215U	Hook fitting plastic basket art. 60402A and plastic bucket support art. P220001E			1 pc.
7966A	Reinforced push-bar for Orion and Vega trolleys			1 pc.
8335SS	Plastic frame with wheels ø 80 mm for Orion and Vega trolleys			1 pc.
P206002A	Bagholder 50 L for Vega trolley fitting plastic push-bar art. 7966A			1 pc.
P220001E	Plastic bucket holder complete with supports (small and medium) for Vega and Arka trolleys			1 pc.
R1050050	Rilsan coated broom/mop holder support for Orion and Vega trolleys			1 pc.
R1200103	Lower Rilsan coated bucket holder for buckets 20 L for Vega and Arka Top-Down trolleys			1 pc.
R1200104	Upper Rilsan coated bucket holder for buckets 20 L for Vega and Arka Top-Down trolleys			1 pc.

⚠ ACCESSORIES TO BE ORDERED SEPARATELY

0000AT0110B	Red plastified bag 50 L			1 pc.
-------------	-------------------------	--	--	-------

VEGA TOP-DOWN® - plastic trolley



REF.	PCK	VOLUME (m³)	GROSS WEIGHT (kg)	SIZE (cm) ↓ ↓ ↓
000LP0322A2	1	0,172	9,3	90x59x112
0000SE0104A	Blue plastic bucket 4 L with plastic handle			1 pc.
0000SE0104A	Red plastic bucket 4 L with plastic handle			1 pc.
0000SE1308A	TOP-DOWN - blue plastic bucket 8 L with plastic handle and hermetic cover			1 pc.
0000SE1308B	TOP-DOWN - red plastic bucket 8 L with plastic handle and hermetic cover			1 pc.
0000SE1308C	TOP-DOWN - yellow plastic bucket 8 L with plastic handle and hermetic cover			1 pc.
0000SM00102U	Hook fitting plastic push-bar art. 7964A - 7966A			1 pc.
0000SM00110U	FLIP - handle holder suitable for basket art. 60402A and bucket holder art. P220001E			1 pc.
0000SM00215U	Hook fitting plastic basket art. 60402A and plastic bucket support art. P220001E			1 pc.
7966A	Reinforced push-bar for Orion and Vega trolleys			1 pc.
8335SS	Plastic frame with wheels ø 80 mm for Orion and Vega trolleys			1 pc.
P206002A	Bagholder 50 L for Vega trolley fitting plastic push-bar art. 7966A			1 pc.
P220001E	Plastic bucket holder complete with supports (small and medium) for Vega and Arka trolleys			1 pc.
R1050050	Rilsan coated broom/mop holder support for Orion and Vega trolleys			1 pc.
R1200113	Lower Rilsan coated bucket holder for 2x 8 L buckets for Vega Top-Down trolley			1 pc.
R1200114	Upper Rilsan coated bucket holder for bucket 8 L for Vega Top-Down trolley			1 pc.

⚠ ACCESSORIES TO BE ORDERED SEPARATELY

0000AT0110B	Red plastified bag 50 L			1 pc.
-------------	-------------------------	--	--	-------

Buckets and wringer trolleys



BUCKET/WRINGER
COMBOS

PLASTIC MOP
TROLLEYS

CHROMED AND RILSAN
COATED TROLLEYS

WRINGERS

MULTI-PURPOSE
BUCKETS

TOP-DOWN® BUCKETS

OTHER PLASTIC
BUCKETS

ARKA TOP-DOWN® MIDI - plastic trolley



REF.	PCK	VOLUME (m³)	GROSS WEIGHT (kg)	SIZE (cm) ↓ ↓ ↓
000LP1211A2	1	0,291	14,32	99x59x111
0000SE0104A	Blue plastic bucket 4 L with plastic handle			1 pc.
0000SE0104A	Red plastic bucket 4 L with plastic handle			1 pc.
0000SE1322B	TOP-DOWN® - red plastic bucket 20 L with plastic handle and hermetic cover			1 pc.
0000SM00110U	FLIP - handle holder suitable for basket art. 60402A and bucket holder art. P220001E			1 pc.
0000SM00129U	Handle holder fitting plastic push-bar art. 7964A - 7966A			1 pc.
0000SM00215U	Hook fitting plastic basket art. 60402A and plastic bucket support art. P220001E			1 pc.
7964A	Reinforced plastic push-bar for Arka trolley			1 pc.
8332SS	Plastic frame with wheels ø 80 mm for Fred 50 L and Arka trolleys			1 pc.
P114011A	Supporting plastic plate for Arka trolley			1 pc.
P220001E	Plastic bucket holder complete with supports (small and medium) for Vega and Arka trolleys			1 pc.
P281001E	Set of two grey pushing grips (right and left) with reinforcements (right and left) and fixing screws for Arka trolley			1 pc.
P606010A	Plastic bagholder 2x50 L with bag-stretchers and cover with chek-list holder for Arka trolley			1 pc.
R1050040	Rilsan coated broom/mop holder support for Arka trolley			1 pc.
R1200104	Upper Rilsan coated bucket holder for buckets 20 L for Vega and Arka Top-Down trolleys			1 pc.

⚠ ACCESSORIES TO BE ORDERED SEPARATELY

0000AT0170A	Plastified bag 48x97 cm, capacity 60 L, blu			1 pc.
0000AT0170B	Plastified bag 48x97 cm, capacity 60 L, red			1 pc.

ARKA TOP-DOWN® MAXI - plastic trolley



REF.	PCK	VOLUME (m³)	GROSS WEIGHT (kg)	SIZE (cm) ↓ ↓ ↓
000LP1221A2	1	0,291	16,62	120x59x111
0000SE0104A	Blue plastic bucket 4 L with plastic handle			1 pc.
0000SE0104A	Red plastic bucket 4 L with plastic handle			1 pc.
0000SE1322A	TOP-DOWN® - blue plastic bucket 20 L with plastic handle and hermetic cover			1 pc.
0000SE1322B	TOP-DOWN® - red plastic bucket 20 L with plastic handle and hermetic cover			1 pc.
0000SM00110U	FLIP - handle holder suitable for basket art. 60402A and bucket holder art. P220001E			1 pc.
0000SM00129U	Handle holder fitting plastic push-bar art. 7964A - 7966A			1 pc.
0000SM00215U	Hook fitting plastic basket art. 60402A and plastic bucket support art. P220001E			1 pc.
7964A	Reinforced plastic push-bar for Arka trolley			1 pc.
8332SS	Plastic frame with wheels ø 80 mm for Fred 50 L and Arka trolleys			1 pc.
P114011A	Supporting plastic plate for Arka trolley			1 pc.
P220001E	Plastic bucket holder complete with supports (small and medium) for Vega and Arka trolleys			1 pc.
P281001E	Set of two grey pushing grips (right and left) with reinforcements (right and left) and fixing screws for Arka trolley			1 pc.
P606010A	Plastic bagholder 2x50 L with bag-stretchers and cover with chek-list holder for Arka trolley			1 pc.
R1050040	Rilsan coated broom/mop holder support for Arka trolley			1 pc.
R1200103	Lower Rilsan coated bucket holder for buckets 20 L for Vega and Arka Top-Down trolleys			1 pc.
R1200104	Upper Rilsan coated bucket holder for buckets 20 L for Vega and Arka Top-Down trolleys			1 pc.

⚠ ACCESSORIES TO BE ORDERED SEPARATELY

0000AT0170A	Plastified bag 48x97 cm, capacity 60 L, blu			1 pc.
0000AT0170B	Plastified bag 48x97 cm, capacity 60 L, red			1 pc.

BUCKETS AND
WRINGER TROLLEYS



PRODUCT PARTIALLY MADE OF PLASTIC COMPONENTS CERTIFIED PSV - PLASTIC SECOND LIFE

Components for plastic mop trolleys

Plastic frame with ø 80 mm wheels for OneFred 30 L and 50 L



REF.	NOTES
8730YSS	

Plastic frame with wheels ø 80 mm for Fred trolley 30 L



REF.	NOTES
8331SS	

Plastic frame with wheels ø 80 mm for Fred 50 L and Arka trolleys



REF.	NOTES
8332SS	

Plastic frame with wheels ø 80 mm for Orion and Vega trolleys



REF.	NOTES
8335SS	

Plastic frame with two wheels ø 80 mm and two wheels ø 200 mm for Arka trolley



REF.	NOTES
8337SS	

Plastic frame with two wheels ø 80 mm and two wheels ø 200 mm for Vega trolley



REF.	NOTES
8338SS	

Buckets and wringer trolleys



BUCKET/WRINGER
COMBOS

**PLASTIC MOP
TROLLEYS**

CHROMED AND RILSAN
COATED TROLLEYS

WRINGERS

MULTI-PURPOSE
BUCKETS

TOP-DOWN® BUCKETS

OTHER PLASTIC
BUCKETS

Rilsan coated push-bar ø 18 mm for OneFred



REF.	NOTES
R8061/2	

Painted push-bar ø 18 mm for Fred trolley



REF.	NOTES
R8061/1	

Plastic grip for OneFred trolley



REF.	NOTES
8731Y	

Plastic grip for Orion and Fred trolleys



REF.	NOTES
7963A	

Reinforced push-bar for Orion and Vega trolleys



REF.	NOTES
7966A	

Bag holder 50 L for Vega trolley fitting plastic push-bar art. 7966A



REF.	NOTES
P206002A	

BUCKET/WRINGER
COMBOS

**PLASTIC MOP
TROLLEYS**

CHROMED AND RILSAN
COATED TROLLEYS

WRINGERS

MULTI-PURPOSE
BUCKETS

TOP-DOWN® BUCKETS

OTHER PLASTIC
BUCKETS

Plastic bag holder for Orion-Fred-Vega trolleys fitting push-bar art. 7963A and supports art. P290800A - P179002A



REF.	NOTES
P206003A	

Bucket reduction for Orion trolley 15 L



REF.	NOTES
60295A	

Reinforced plastic push-bar for Arka trolley



REF.	NOTES
7964A	

Set of two grey pushing grips (right and left) with reinforcements (right and left) and fixing screws for Arka trolley



REF.	NOTES
P281001E	

Supporting plastic plate for Arka trolley



REF.	NOTES
P114011A	

Plastic bag holder complete with bag-stretchers and cover with chek-list holder for Arka trolley



REF.	NOTES
P306010A	100 L
P606010A	2x50 L

Plastic divider 2x50 L for bag holder art. P606010A for Arka trolley



REF.	NOTES
P206010E	

Buckets and wringer trolleys



BUCKET/WRINGER
COMBOS

**PLASTIC MOP
TROLLEYS**

CHROMED AND RILSAN
COATED TROLLEYS

WRINGERS

MULTI-PURPOSE
BUCKETS

TOP-DOWN® BUCKETS

OTHER PLASTIC
BUCKETS

Plastic bucket holder complete with supports (small and medium) for Vega and Arka trolleys



REF.	NOTES
P220001E	

Big support for plastic bucket holder art. P220001E



REF.	NOTES
P120004E	

Plastic basket or bucket holder complete with supports for Vega and Arka trolleys



REF.	NOTES
P224002E	

Lower Rilsan coated bucket holder for buckets 20 L for Vega and Arka Top-Down® trolleys



REF.	NOTES
R1200103	

Upper Rilsan coated bucket holder for buckets 20 L for Vega and Arka Top-Down® trolleys

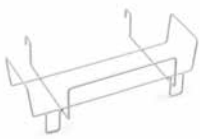

REF.	NOTES
R1200104	

Lower Rilsan coated bucket holder for 2x 8 L buckets for Vega Top-Down® trolley



REF.	NOTES
R1200113	

Upper Rilsan coated bucket holder for bucket 8 L for Vega Top-Down® trolley

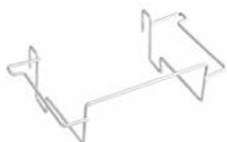

REF.	NOTES
R1200114	

BUCKET/WRINGER
COMBOS

**PLASTIC MOP
TROLLEYS**

CHROMED AND RILSAN
COATED TROLLEYS

WRINGERS

MULTI-PURPOSE
BUCKETS

TOP-DOWN® BUCKETS

OTHER PLASTIC
BUCKETS

Accessories for plastic mop trolleys

Rilsan coated basket fitting the push-bar art. 8061/1 and R8061/2 for Fred and OneFred trolley



REF.	NOTES	SIZE (cm) ↓ ↓ ↓
R8218		18x35x14

Plastic carry basket for OneFred



REF.	NOTES
60406Y	

Plastic support for plastic basket art. 60402A, paper holder art. P225004A and quivers

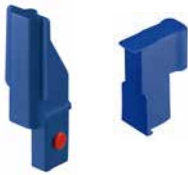

REF.	NOTES
P290800A	1. for Orion-Fred trolleys frame
P179002A	2. for bag holder art. P206002A of Vega trolley

Plastic carry basket



REF.	NOTES	SIZE (cm) ↓ ↓ ↓
60402A		32x13x14

Set of plastic paper holder with cover complete with 3 hooks



REF.	NOTES
P225004A	

Plastic quiver for polybags



REF.	NOTES
P120007A	

Buckets and wringer trolleys



BUCKET/WRINGER
COMBOS

**PLASTIC MOP
TROLLEYS**

CHROMED AND RILSAN
COATED TROLLEYS

WRINGERS

MULTI-PURPOSE
BUCKETS

TOP-DOWN® BUCKETS

OTHER PLASTIC
BUCKETS

Plastic quiver for window squeegees, washers, scrapers



REF.	NOTES
P120008A	

Rilsan coated broom/mop holder support for Orion and Vega trolleys

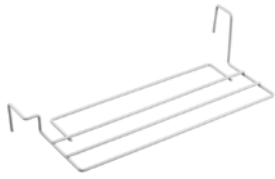

REF.	NOTES
R1050050	

Rilsan coated broom/mop holder support for Arka trolley

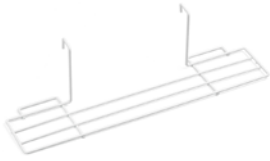

REF.	NOTES
R1050040	

Mop holder kit for OneFred trolleys



REF.	NOTES
0000SM00299	

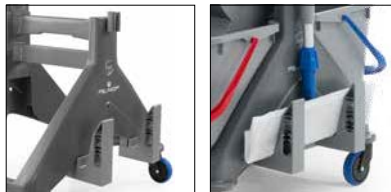

Can be applied on models with plastic handle

OneFred trolley sign hook



REF.	NOTES
0000SM00248U	



Trolleys 25 L

MINI JACK - chromed trolley 25 L



REF.	PCK	VOLUME (m³)	GROSS WEIGHT (kg)	SIZE (cm) ↓ ↓ ↓
8010	1	0,123	7,11	51x40x87
7004A	REGULAR - blue plastic down-press wringer with plastic gears			1 pc.
8008	Chromed frame with wheels ø 80 mm and bumpers			1 pc.
8107B	Red plastic bucket 25 L with plastic handle			1 pc.

FILMOP - chromed trolley 25 L



REF.	PCK	VOLUME (m³)	GROSS WEIGHT (kg)	SIZE (cm) ↓ ↓ ↓
8016	1	0,133	8,59	56x40x98
7004A	REGULAR - blue plastic down-press wringer with plastic gears			1 pc.
8107B	Red plastic bucket 25 L with plastic handle			1 pc.
8205/1	Chromed basket for Mini Jack and Filmop trolleys			1 pc.
8316	Chromed frame with push-bar, wheels ø 80 mm and bumpers			1 pc.

Trolleys 30 L

JACK - chromed trolley 30 L



REF.	PCK	VOLUME (m³)	GROSS WEIGHT (kg)	SIZE (cm) ↓ ↓ ↓
8024	1	0,137	9,09	67x39x88
7004A	REGULAR - blue plastic down-press wringer with plastic gears			1 pc.
8062	Chromed push-bar for trolleys art. 8036, 8024 and 8010			1 pc.
8108A	Blue plastic bucket 15 L with plastic handle			1 pc.
8108B	Red plastic bucket 15 L with plastic handle			1 pc.
8300	Chromed frame with wheels ø 80 mm and bumpers			1 pc.

JACK - Rilsan coated trolley 30 L



REF.	PCK	VOLUME (m³)	GROSS WEIGHT (kg)	SIZE (cm) ↓ ↓ ↓
R8024	1	0,137	9,09	67x39x88
7004A	REGULAR - blue plastic down-press wringer with plastic gears			1 pc.
8108A	Blue plastic bucket 15 L with plastic handle			1 pc.
8108B	Red plastic bucket 15 L with plastic handle			1 pc.
R8062	Rilsan coated push-bar for trolleys art. R8024 and R8036			1 pc.
R8300	Rilsan coated frame with wheels ø 80 mm and bumpers			1 pc.

Buckets and wringer trolleys



BUCKET/WRINGER
COMBOS

PLASTIC MOP
TROLLEYS

**CHROMED AND RILSAN
COATED TROLLEYS**

WRINGERS

MULTI-PURPOSE
BUCKETS

TOP-DOWN® BUCKETS

OTHER PLASTIC
BUCKETS

FILMOP - chromed trolley 30 L



REF.	PCK	VOLUME (m³)	GROSS WEIGHT (kg)	SIZE (cm) ↓ ↓ ↓
8017	1	0,192	11,59	67x39x84
7004A	REGULAR - blue plastic down-press wringer with plastic gears			1 pc.
8108A	Blue plastic bucket 15 L with plastic handle			1 pc.
8108B	Red plastic bucket 15 L with plastic handle			1 pc.
8317	Chromed frame with push-bar, basket, bag holder, wheels ø 80 mm and bumpers			1 pc.

FILMOP - Rilsan coated trolley 30 L



REF.	PCK	VOLUME (m³)	GROSS WEIGHT (kg)	SIZE (cm) ↓ ↓ ↓
R8017	1	0,192	11,59	67x39x84
7004A	REGULAR - blue plastic down-press wringer with plastic gears			1 pc.
8108A	Blue plastic bucket 15 L with plastic handle			1 pc.
8108B	Red plastic bucket 15 L with plastic handle			1 pc.
R8317	Rilsan coated frame with push-bar, basket, bagholder, wheels ø 80 mm and bumpers			1 pc.

SCALA - chromed trolley 30 L



REF.	PCK	VOLUME (m³)	GROSS WEIGHT (kg)	SIZE (cm) ↓ ↓ ↓
8020	1	0,333	11,54	74x45x111
7004A	REGULAR - blue plastic down-press wringer with plastic gears			1 pc.
8108A	Blue plastic bucket 15 L with plastic handle			1 pc.
8108B	Red plastic bucket 15 L with plastic handle			1 pc.
8801	Chromed frame with two wheels ø 80 mm with bumper and two wheels ø 175 mm			1 pc.

Trolleys 50 L

JACK - chromed trolley 50 L with revolving wringer



REF.	PCK	VOLUME (m³)	GROSS WEIGHT (kg)	SIZE (cm) ↓ ↓ ↓
8032	1	0,192	10,81	78x40x83
7004A	REGULAR - blue plastic down-press wringer with plastic gears			1 pc.
8062/1	Chromed push-bar for trolley art. 8032			1 pc.
8107A	Blue plastic bucket 25 L with plastic handle			1 pc.
8107B	Red plastic bucket 25 L with plastic handle			1 pc.
8314	Chromed frame with wheels ø 80 mm and bumpers			1 pc.



BUCKET/WRINGER
COMBOS

PLASTIC MOP
TROLLEYS

**CHROMED AND RILSAN
COATED TROLLEYS**

WRINGERS

MULTI-PURPOSE
BUCKETS

TOP-DOWN® BUCKETS

OTHER PLASTIC
BUCKETS

JACK - chromed trolley 50 L



REF.	PCK	VOLUME (m³)	GROSS WEIGHT (kg)	SIZE (cm) ↓ ↓ ↓
8036	1	0,178	9,59	73x40x93
7004A	REGULAR - blue plastic down-press wringer with plastic gears			1 pc.
8062	Chromed push-bar for trolleys art. 8036, 8024 and 8010			1 pc.
8107A	Blue plastic bucket 25 L with plastic handle			1 pc.
8107B	Red plastic bucket 25 L with plastic handle			1 pc.
8301	Chromed frame with wheels ø 80 mm and bumpers			1 pc.

FILMOP - chromed trolley 50 L



REF.	PCK	VOLUME (m³)	GROSS WEIGHT (kg)	SIZE (cm) ↓ ↓ ↓
8018	1	0,192	11,31	99x41x88
7004A	REGULAR - blue plastic down-press wringer with plastic gears			1 pc.
8028	Chromed frame with push-bar, basket, wheels ø 80 mm and bumpers			1 pc.
8107A	Blue plastic bucket 25 L with plastic handle			1 pc.
8107B	Red plastic bucket 25 L with plastic handle			1 pc.

BUCKETS AND
WRINGER TROLLEYS

Accessories for chromed and Rilsan coated trolleys

Chromed basket for Mini Jack and Filmop trolleys



REF.	NOTES	SIZE (cm) ↓ ↓ ↓
8205/1		30,5x17,5x13,5

Chromed basket fitting push-bar for trolleys art. 8036, 8024 and 8010



REF.	NOTES	SIZE (cm) ↓ ↓ ↓
8215		33x19,5x14,5

Chromed basket for Filmop trolley art. 8018



REF.	NOTES	SIZE (cm) ↓ ↓ ↓
C30152		40x20x15,5



BUCKET/WRINGER COMBOS

PLASTIC MOP TROLLEYS

CHROMED AND RILSAN COATED TROLLEYS

WRINGERS

MULTI-PURPOSE BUCKETS

TOP-DOWN® BUCKETS

OTHER PLASTIC BUCKETS

NEW Optimal, efficient and ergonomic wringing

Boost optimises wringing, reducing drastically the efforts: the unique flat wringer **wrings 20% more with half the effort** compared to traditional wringers, minimizing cleaning time and costs while protecting the health and well-being of the operator.

+20%
WRINGING

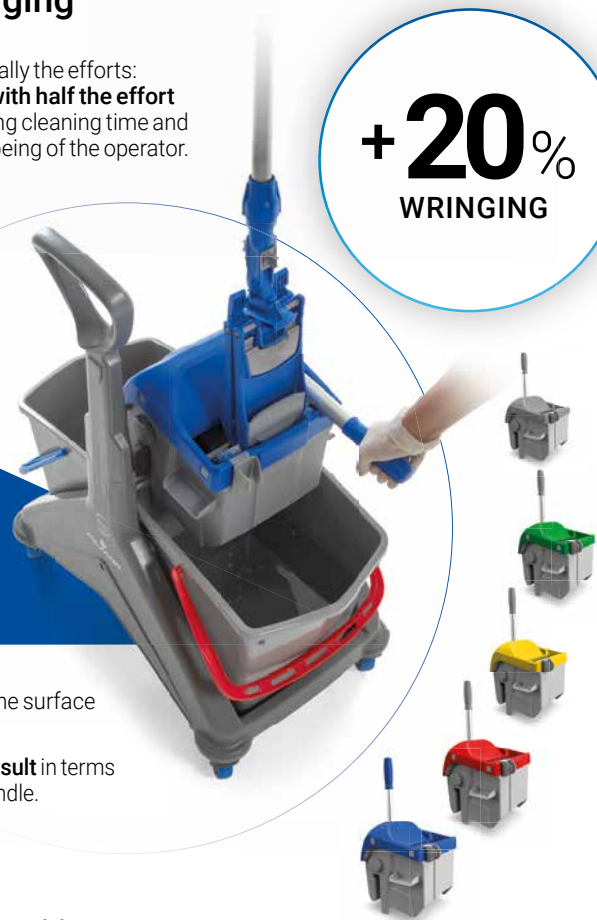
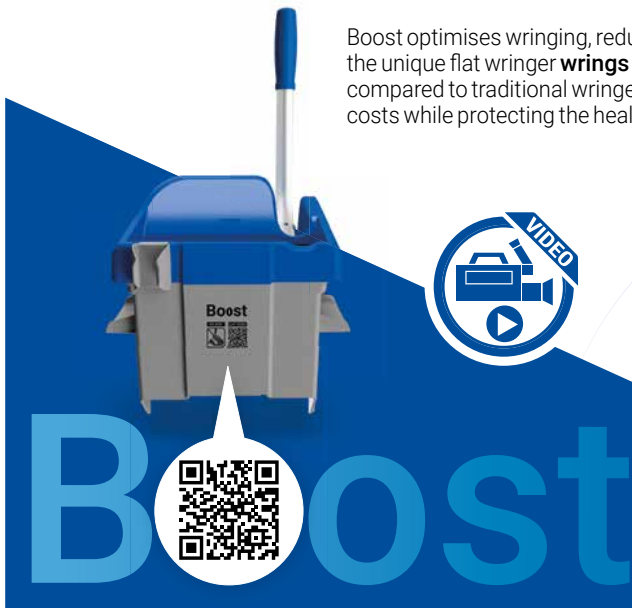

The deep and uniform pressure applied by the plate on the flat mop ensures **a complete wringing** and a **uniform distribution of the cleaning solution** on the surface to clean, ensuring the best result in terms of cleaning and hygiene.

Performance is steady over time: Boost allows you to **always get the desired result** in terms of wringing and soaking of the flat mop, whatever the pressure applied to the handle.

HALF
EFFORT

Boost **prevents the onset of occupational diseases over time**: the wringer makes the effort and the operator simply has to push the handle to the end of the stroke.

Unlike traditional wringers that force the operator to repeat the operation several times to achieve the desired result with Boost **it is sufficient to lower the handle just 1 time to obtain the ideal wringing.**

100%
VERSATILE

Boost meets different wringing needs: it is characterized by an innovative **adjustment system that allows to optimize the level of wringing** according to the degree of humidity you want to obtain and the type of flat mop in use.



TWICE







Specially designed to be used with **flat mopping systems**, it can be matched to any **Filmop trolley** line and to the special range of **wringer buckets**.

Boost wringer





BOOST - plastic flat wringer

NEW

REF.	NOTES	PCK	VOLUME (m³)	GROSS WEIGHT (kg)
7003UA	grey with blue top and handgrip 	1	0,021	2,11
7003UB	grey with red top 	1	0,021	2,11
7003UC	grey with yellow top 	1	0,021	2,11
7003UF	grey with green top 	1	0,021	2,11
7003U	completely grey 	1	0,021	2,11

Plastic top for Boost wringer



REF.	NOTES
SLP036000001A	
SLP036000001B	
SLP036000001C	
SLP036000001F	
SLP036000001U	



Wringing plastic plate for Boost wringer



REF.	NOTES
SLP036000003U	

Aluminum handle for Boost wringer



REF.	NOTES
8638A	with blue handgrup 
8638U	with gray handgrip 

Spring for Boost wringer



REF.	NOTES
U100017	

Handle holder for wringer



REF.	NOTES
P1780011U	

Fixing clip



REF.	NOTES
60005/2U	



BUCKET/WRINGER
COMBOS

PLASTIC MOP
TROLLEYS

CHROMED AND RILSAN
COATED TROLLEYS

WRINGERS

MULTI-PURPOSE
BUCKETS

TOP-DOWN® BUCKETS

OTHER PLASTIC
BUCKETS

Regular wringer

REGULAR - plastic down-press wringer with plastic gears



REF.	NOTES	PCK	VOLUME (m³)	GROSS WEIGHT (kg)
7004A		135	2,9	264,87
7004E		135	2,9	264,87



Components for Regular

Plastic jaw for Regular wringer



REF.	NOTES
8640	

Rotating handle holder for wringers art. 7004, 8000 and 8004



REF.	NOTES
8599	

Plastic vertical gear for Regular wringer



REF.	NOTES
60500	right vertical gear
60501	left vertical gear

Plastic round gear for Regular wringer



REF.	NOTES
60502	Right gear
60503	Left gear

Aluminium pin for Regular wringer



REF.	NOTES
V8643	

Chromed metal handle with plastic grip for Regular wringer



REF.	NOTES
A8644A	

BUCKET/WRINGER
COMBOS

PLASTIC MOP
TROLLEYS

CHROMED AND RILSAN
COATED TROLLEYS

WRINGERS

MULTI-PURPOSE
BUCKETS

TOP-DOWN® BUCKETS

OTHER PLASTIC
BUCKETS

Inside spring for Regular wringer



REF.	NOTES
8645	

Fixing clip



REF.	NOTES
60005A	

Punto wringer

PUNTO - plastic wringer with adjustable roll



REF.	NOTES	PCK	VOLUME (m³)	GROSS WEIGHT (kg)
10000A	roll with position "+" (for a stronger wringing performance)	1	0,028	3,42
12000A	roll with position "-" (for a lighter wringing performance)	1	0,028	3,42
14000A	roll with central position (for a standard wringing performance)	1	0,028	3,42



Components for Punto

Universal rubber roll ø 48 mm for Punto wringer



REF.	NOTES
P1780029U	

Roll support with covering for Punto wringer



REF.	NOTES
P2780060	

Stainless steel pin for roll of Punto wringer



REF.	NOTES
V1010801	

Buckets and wringer trolleys



BUCKET/WRINGER
COMBOS

PLASTIC MOP
TROLLEYS

CHROMED AND RILSAN
COATED TROLLEYS

WRINGERS

MULTI-PURPOSE
BUCKETS

TOP-DOWN® BUCKETS

OTHER PLASTIC
BUCKETS

Inside spring for Punto wringer



REF.	NOTES
U100007	

Set of gears for Punto wringer



REF.	NOTES
P2780030	left set
P2780040	right set

Painted metal handle for Punto wringer



REF.	NOTES
P278006A	

Aluminium pin for handle for Punto wringer



REF.	NOTES
A1110810	

Fixing clip



REF.	NOTES
60005A	

Handle holder for Punto wringer



REF.	NOTES
P1780010	

Deep wringer

DEEP - plastic side press wringer without bottom



REF.	NOTES	PCK	VOLUME (m³)	GROSS WEIGHT (kg)
7002A		1	0,028	2,56



BUCKET/WRINGER
COMBOS

PLASTIC MOP
TROLLEYS

CHROMED AND RILSAN
COATED TROLLEYS

WRINGERS

MULTI-PURPOSE
BUCKETS

TOP-DOWN® BUCKETS

OTHER PLASTIC
BUCKETS

Components for Deep

Painted metal handle for Deep wringer



REF.

NOTES

8633A

Painted pin for Deep wringer



REF.

NOTES

V8632

Covering for Deep wringer



REF.

NOTES

60356A

Plastic connecting rod for Deep wringer



REF.

NOTES

60307A

right connecting rod

60308A

left connecting rod

Rotating handle holder for Deep wringer



REF.

NOTES

60311H

Spring for Deep wringer



REF.

NOTES

8154

Fixing clip



REF.

NOTES

60005A



BUCKET/WRINGER
COMBOS

PLASTIC MOP
TROLLEYS

CHROMED AND RILSAN
COATED TROLLEYS

WRINGERS

MULTI-PURPOSE
BUCKETS

TOP-DOWN® BUCKETS

OTHER PLASTIC
BUCKETS

Side-press wringers

Plastic side-press wringer with plastic covering



REF.	NOTES	PCK	VOLUME (m³)	GROSS WEIGHT (kg)
8002/1A		10	0,178	19,66

Plastic side-press wringer



REF.	NOTES	PCK	VOLUME (m³)	GROSS WEIGHT (kg)
8002A		105	2,064	182,7

Components for wringers art. 8002 - 8002-1

Chromed metal handle with plastic grip for wringers art. 8002 and 8002/1



REF.	NOTES
8617A	

Painted pin for wringers art. 8002 and 8002/1



REF.	NOTES
V8618	

Reducer for wringer art. 8002



REF.	NOTES
8623E	

Covering for wringers art. 8002 and 8002/1



REF.	NOTES
60156A	

BUCKET/WRINGER
COMBOS

PLASTIC MOP
TROLLEYS

CHROMED AND RILSAN
COATED TROLLEYS

WRINGERS

MULTI-PURPOSE
BUCKETS

TOP-DOWN® BUCKETS

OTHER PLASTIC
BUCKETS

Plastic connecting rod for wringers art. 8002 and 8002/1



REF.	NOTES
60107A	right connecting rod
60108A	left connecting rod

Spring 81 mm for wringers art. 8002 and 8002/1



REF.	NOTES
8151	

Fixing clip



REF.	NOTES
60005A	

Wringers with jaws

Plastic down-press wringer with galvanized metal gears



REF.	NOTES	PCK	VOLUME (m³)	GROSS WEIGHT (kg)
8000A		12	0,275	47,68

For mops more than 400 gr

Plastic down-press wringer with plastic gears



REF.	NOTES	PCK	VOLUME (m³)	GROSS WEIGHT (kg)
8004A		12	0,275	36,88

For mops more than 400 gr



BUCKET/WRINGER
COMBOS

PLASTIC MOP
TROLLEYS

CHROMED AND RILSAN
COATED TROLLEYS

WRINGERS

MULTI-PURPOSE
BUCKETS

TOP-DOWN® BUCKETS

OTHER PLASTIC
BUCKETS

Components for wringers art. 8000 - 8004

Jaw for wringers art. 8000 and 8004



REF.	NOTES
8066	

Rotating handle holder for wringers art. 7004, 8000 and 8004



REF.	NOTES
8599	

Aluminium pin for plastic round gear for wringer art. 8004



REF.	NOTES
0000SLA30401	long
0000SLA30402	short

Galvanized metal handle for wringers art. 8000 and 8004



REF.	NOTES
8608/1	

Handle fixing flanges with screws for wringers art. 8000 and 8004



REF.	NOTES
8613	

Plastic round gear for wringer art. 8000



REF.	NOTES
60059	Right gear
60060	Left gear

Plastic vertical gear for wringer art. 8004



REF.	NOTES
60057	right vertical gear
60058	left vertical gear

Inside spring 184 mm for wringers art. 8000 and 8004



REF.	NOTES
8068	

BUCKET/WRINGER
COMBOS

PLASTIC MOP
TROLLEYS

CHROMED AND RILSAN
COATED TROLLEYS

WRINGERS

MULTI-PURPOSE
BUCKETS

TOP-DOWN® BUCKETS

OTHER PLASTIC
BUCKETS

Round galvanized metal gear with pin for wringer art. 8000



REF.	NOTES
Z30132	with short pin
Z30133	with long pin

Vertical galvanized metal gear for wringer art. 8000



REF.	NOTES
Z30130	right vertical gear
Z30131	left vertical gear

Reducer for wringers art. 8000 and 8004



REF.	NOTES
8601	

Buckets and wringer trolleys



BUCKET/WRINGER
COMBOS

PLASTIC MOP
TROLLEYS

CHROMED AND RILSAN
COATED TROLLEYS

WRINGERS

**MULTI-PURPOSE
BUCKETS**

TOP-DOWN® BUCKETS

OTHER PLASTIC
BUCKETS

PRISMA - plastic bucket 28 L with double handle



REF.	NOTES	PCK	VOLUME (m³)	GROSS WEIGHT (kg)	SIZE (cm) ↓ ↓ ↓
0000SE0628U		10	0,225	15,92	38x57,5x27

PRISMA - plastic bucket 28 L with double handle and wheels



REF.	NOTES	PCK	VOLUME (m³)	GROSS WEIGHT (kg)	SIZE (cm) ↓ ↓ ↓
0000SE1628U		1	0,092	2,92	38x57,5x34

PRISMA - plastic bucket 28 L with double handle and 2 rectangular plastic baskets 6 L



REF.	NOTES	PCK	VOLUME (m³)	GROSS WEIGHT (kg)	SIZE (cm) ↓ ↓ ↓
0010SE0628U		1	0,092	3,38	38x57,5x28,5

PRISMA - plastic bucket 28 L with double handle, 2 rectangular plastic baskets 6 L and sieve



REF.	NOTES	PCK	VOLUME (m³)	GROSS WEIGHT (kg)	SIZE (cm) ↓ ↓ ↓
0020SE0628U		1	0,092	3,52	38x57,5x35

BUCKETS AND
WRINGER TROLLEYS

Components and accessories for Prisma bucket

Plastic cover for bucket 28 L



REF.	NOTES	SIZE (cm) ↓ ↓ ↓
0000CP1128U		33x53x2,8

Rectangular plastic basket 6 L with coloured slots



REF.	NOTES	PCK	VOLUME (m³)	GROSS WEIGHT (kg)	SIZE (cm) ↓ ↓ ↓
P0190047UA		10	0,041	5,32	33x13x26,5
P0190047UB		10	0,041	5,32	33x13x26,5

Plastic sieve for rectangular basket 6 L



REF.	NOTES
21005U	



Plastic cover for rectangular basket 6 L



REF.	NOTES	SIZE (cm) ↓ ↓ ↓
P0190049U		13,5x29,8



Stainless steel sieve for rectangular basket 6 L



REF.	NOTES	SIZE (cm) ↓ ↓ ↓
I2190039		24,5x9,5



Buckets and wringer trolleys



BUCKET/WRINGER
COMBOS

PLASTIC MOP
TROLLEYS

CHROMED AND RILSAN
COATED TROLLEYS

WRINGERS

**MULTI-PURPOSE
BUCKETS**

TOP-DOWN® BUCKETS

OTHER PLASTIC
BUCKETS

Plastic basket with 3 compartments complete with cover and handle



REF.	NOTES	PCK	VOLUME (m³)	GROSS WEIGHT (kg)	SIZE (cm) ↓ ↓ ↓
P1190048UB		5	0,055	3,89	33x13,5x20,5

Toilet brush



REF.	NOTES	PCK	VOLUME (m³)	GROSS WEIGHT (kg)	SIZE (cm) ↓ ↓ ↓
9148		20	0,024	3,94	61

Rectangular tool with strips 2,5 cm for strap tape system, with Lock System



REF.	NOTES	PCK	VOLUME (m³)	GROSS WEIGHT (kg)	SIZE (cm) ↓ ↓ ↓
5390U		10	0,011	2,23	20x8

MICRO-ACTIVA - ultra-microfiber mop with backing for strap tape system



REF.	NOTES	PCK	VOLUME (m³)	GROSS WEIGHT (kg)	SIZE (cm) ↓ ↓ ↓
000EPN01010		25	0,011	0,97	25x10

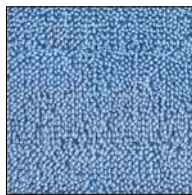

TOP-CLEAN - plastic mop holder with grip and strips 2,5 cm for strap tape system



REF.	NOTES	PCK	VOLUME (m³)	GROSS WEIGHT (kg)	SIZE (cm) ↓ ↓ ↓
5233U		10	0,016	2,28	30
5234U		10	0,019	2,9	40



BUCKETS AND
WRINGER TROLLEYS

BUCKET/WRINGER
COMBOS

PLASTIC MOP
TROLLEYS

CHROMED AND RILSAN
COATED TROLLEYS

WRINGERS

**MULTI-PURPOSE
BUCKETS**

TOP-DOWN® BUCKETS

OTHER PLASTIC
BUCKETS

Ultra-microfiber mop head with backing for strap tape system



REF.	NOTES	PCK	VOLUME (m³)	GROSS WEIGHT (kg)	SIZE (cm) ↓ ↓ ↓
0000PN02016		25	0,007	0,99	30x11
0000PN03016		25	0,011	1,49	40x11



Ideal for stainless steel surfaces, mirrors and windows

Wheel ø 50 mm



REF.	NOTES
7949	For King, Spider, Ro-cket Wheels, Duo Pro System, Prisma, Twin, Top-Down®, Pick-Up, Trend and code 0000SE1428

Wheel ø 35 mm



REF.	NOTES
2793	for Prisma, Twin, Top-Down®, Pick-Up, Trend and art. 0000SE1428

Twin bucket

TWIN - plastic bucket 2x10 L with two plastic handles



REF.	NOTES	PCK	VOLUME (m³)	GROSS WEIGHT (kg)	SIZE (cm) ↓ ↓ ↓
7914A		5	0,132	8,79	36x45x26



Fitting window washer 35 cm

Plastic sieve for Twin bucket



REF.	NOTES
21021A	

Fitting window washer 35 cm

Buckets and wringer trolleys



BUCKET/WRINGER
COMBOS

PLASTIC MOP
TROLLEYS

CHROMED AND RILSAN
COATED TROLLEYS

WRINGERS

**MULTI-PURPOSE
BUCKETS**

TOP-DOWN® BUCKETS

OTHER PLASTIC
BUCKETS

Plastic sieve for Twin bucket



REF.	NOTES
21002	

Available while stocks last

Plastic lid for Twin bucket



REF.	NOTES
60294U	

Set of holders for plastic cover for Twin bucket



REF.	NOTES
7915A	

Wheel ø 35 mm



REF.	NOTES
2793	for Prisma, Twin, Top-Down®, Pick-Up, Trend and art. 0000SE1428

Wheel ø 50 mm



REF.	NOTES
7949	For King, Spider, Ro-cket Wheels, Duo Pro System, Prisma, Twin, Top-Down®, Pick-Up, Trend and code 0000SE1428

BUCKETS AND
WRINGER TROLLEYS

Top-Down® buckets complete

TOP-DOWN® - plastic bucket with plastic handle and hermetic cover



REF.	NOTES	CAPACITY (L)	PCK	VOLUME (m³)	GROSS WEIGHT (kg)	SIZE (cm) ↓ ↓ ↓
0000SE1308A		8	5	0,043	3,46	17x36x23
0000SE1308B		8	5	0,043	3,46	17x36x23
0000SE1308C		8	5	0,043	3,46	17x36x23
0000SE1310A		10	5	0,094	7,45	24x55x19
0000SE1310B		10	5	0,094	7,45	24x55x19
0000SE1314A		14	4	0,086	6,63	20x77x18
0000SE1314FT		14	4	0,086	6,63	20x77x18
0000SE1322A		20	4	0,094	6,93	24x55x27
0000SE1322B		20	4	0,094	6,93	24x55x27
0000SE1322U		20	4	0,094	6,93	24x55x27

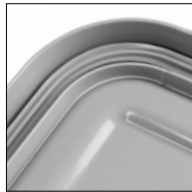

They are the ideal solution for cloth soaking procedures

Components and accessories for Top-Down®

Plastic bucket 8 L with plastic handle



REF.	NOTES	PCK	VOLUME (m³)	GROSS WEIGHT (kg)	SIZE (cm) ↓ ↓ ↓
0000SE1208A		9	0,048	4,66	17x36x23
0000SE1208B		9	0,048	4,66	17x36x23
0000SE1208C		9	0,048	4,66	17x36x23



Plastic bucket 10 L with plastic handle



REF.	NOTES	PCK	VOLUME (m³)	GROSS WEIGHT (kg)	SIZE (cm) ↓ ↓ ↓
0000SE1210A		12	0,169	11,88	24x55x19
0000SE1210B		12	0,169	11,88	24x55x19



Buckets and wringer trolleys



BUCKET/WRINGER
COMBOS

WRINGERS

PLASTIC MOP
TROLLEYS

CHROMED AND RILSAN
COATED TROLLEYS

MULTI-PURPOSE
BUCKETS

TOP-DOWN® BUCKETS

OTHER PLASTIC
BUCKETS

Plastic bucket 14 L with plastic handle



REF.	NOTES	PCK	VOLUME (m³)	GROSS WEIGHT (kg)	SIZE (cm) ↓ ↓ ↓
0000SE1214A		10	0,148	11,57	20x77x18
0000SE1214FT		10	0,148	11,57	20x77x18

Plastic bucket 20 L with plastic handle



REF.	NOTES	PCK	VOLUME (m³)	GROSS WEIGHT (kg)	SIZE (cm) ↓ ↓ ↓
0000SE1222A		10	0,169	12,6	24x55x27
0000SE1222B		10	0,169	12,6	24x55x27
0000SE1222U		10	0,169	12,6	24x55x27

Hermetic plastic cover for Top-Down® bucket



REF.	NOTES	SIZE (cm) ↓ ↓ ↓
0000CP1108U	for bucket 8 L	-
0000CP1114U	for bucket 14 L	-
0000CP1122U	for bucket 10 and 20 L	24,5x54,5x3,5

Plastic divider for Top-Down® bucket 20 L



REF.	NOTES	PCK	VOLUME (m³)	GROSS WEIGHT (kg)
P190350E		5	0,024	2,67

The specific plastic reducer is ideal to keep the mop compact inside the bucket and to make it easier to pick up them from the bucket directly with the mop holder

Pierced plastic sieve for Top-Down® bucket



REF.	NOTES	PCK	VOLUME (m³)	GROSS WEIGHT (kg)	SIZE (cm) ↓ ↓ ↓
P1190041U	for Top-Down® 8 L	9	-	1,52	33,3x14,2x2,2
P1190042U	for Top-Down® 10 and 20 L	10	0,031	4,24	54x20x3

Ideal for a uniform distribution of the cleaning solution - For a quick pre-soaking (max 15 minutes)



BUCKET/WRINGER
COMBOS

PLASTIC MOP
TROLLEYS

CHROMED AND RILSAN
COATED TROLLEYS

WRINGERS

MULTI-PURPOSE
BUCKETS

TOP-DOWN® BUCKETS

OTHER PLASTIC
BUCKETS

Stainless steel sieve for Top-Down® bucket 20 L

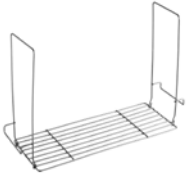

REF.	NOTES
I2190044	

Plastic sieve for Top-Down® bucket 10 and 20 L



REF.	NOTES
21004	



Wheel ø 35 mm



REF.	NOTES
2793	for Prisma, Twin, Top-Down®, Pick-Up, Trend and art. 0000SE1428

Wheel ø 50 mm



REF.	NOTES
7949	For King, Spider, Rocket Wheels, Duo Pro System, Prisma, Twin, Top-Down®, Pick-Up, Trend and code 0000SE1428

Buckets and wringer trolleys



BUCKET/WRINGER
COMBOS

PLASTIC MOP
TROLLEYS

CHROMED AND RILSAN
COATED TROLLEYS

WRINGERS

MULTI-PURPOSE
BUCKETS

TOP-DOWN® BUCKETS

**OTHER PLASTIC
BUCKETS**

Other buckets

Plastic bucket 25 L with plastic handle



REF.	NOTES	SIZE (cm) ↓ ↓ ↓
8107A		36,2x32,4x31,7
8107B		36,2x32,4x31,7



Grey plastic 25l mop bucket with coloured plastic handle for OneFred



REF.	NOTES	SIZE (cm) ↓ ↓ ↓
0000SE0125UA		36,8x40,5x32,3
0000SE0125UB		36,8x40,5x32,3



Plastic bucket 15 L with plastic handle



REF.	NOTES	SIZE (cm) ↓ ↓ ↓
8108A		34x33,5x28,3
8108B		34x33,5x28,3
8108C		34x33,5x28,3



Grey plastic 15l mop bucket with coloured plastic handle for OneFred



REF.	NOTES	SIZE (cm) ↓ ↓ ↓
0000SE0115UA		32,5x32,7x32
0000SE0115UB		32,5x32,7x32



Plastic bucket 12 L with plastic handle



REF.	NOTES	SIZE (cm) ↓ ↓ ↓
8211/1A		27,7x32,5x26
8211/1B		27,7x32,5x26



BUCKET/WRINGER
COMBOS

PLASTIC MOP
TROLLEYS

CHROMED AND RILSAN
COATED TROLLEYS

WRINGERS

MULTI-PURPOSE
BUCKETS

TOP-DOWN® BUCKETS

**OTHER PLASTIC
BUCKETS**

Plastic bucket 8 L with plastic handle on the edge



REF.	NOTES	SIZE (cm) ↓ ↓ ↓
0000SE0108A		16x33x23,5
0000SE0108B		16x33x23,5
0000SE0108C		16x33x23,5



Plastic bucket 6 L with plastic handle



REF.	NOTES	SIZE (cm) ↓ ↓ ↓
8218A		20,8x26x21,5
8218B		20,8x26x21,5
8218C		20,8x26x21,5
8218F		20,8x26x21,5



Grey plastic bucket 6 L with coloured short plastic handle



REF.	NOTES	SIZE (cm) ↓ ↓ ↓
0000SE0106U		21x26x23,5
0000SE0106UA		21x26x23,5
0000SE0106UB		21x26x23,5
0000SE0106UC		21x26x23,5
0000SE0106UF		21x26x23,5



Plastic bucket 4 L with plastic handle



REF.	NOTES	SIZE (cm) ↓ ↓ ↓
0000SE0104A		17x25,5x19,5
0000SE0104A		17x25,5x19,5
0000SE0104C		17x25,5x19,5
0000SE0104F		17x25,5x19,5



Buckets and wringer trolleys



BUCKET/WRINGER
COMBOS

PLASTIC MOP
TROLLEYS

CHROMED AND RILSAN
COATED TROLLEYS

WRINGERS

MULTI-PURPOSE
BUCKETS

TOP-DOWN® BUCKETS

OTHER PLASTIC
BUCKETS

Grey plastic bucket 4 L with coloured plastic handle on the edge



REF.	NOTES	SIZE (cm) ↓ ↓ ↓
0000SE0204U		16,5x21x22,5
0000SE0204UA		16,5x21x22,5
0000SE0204UB		16,5x21x22,5
0000SE0204UC		16,5x21x22,5
0000SE0204UF		16,5x21x22,5



Plastic bucket 28 L with 2 plastic handles and removable divider



REF.	NOTES	SIZE (cm) ↓ ↓ ↓
0000SE1128B		32,5x44,5x31,5



Plastic bucket 28 L with plastic handle



REF.	NOTES	SIZE (cm) ↓ ↓ ↓
0000SE1428A		32x52x27
0000SE1428B		32x52x27



BUCKET/WRINGER
COMBOS

PLASTIC MOP
TROLLEYS

CHROMED AND RILSAN
COATED TROLLEYS

WRINGERS

MULTI-PURPOSE
BUCKETS

TOP-DOWN® BUCKETS

OTHER PLASTIC
BUCKETS

Accessories for other buckets

Set of 3 stickers for buckets

REF.	NOTES
3048	

Wringer with roll for microfiber cloths fitting buckets 6 L and 4 L

REF.	NOTES	PCK	VOLUME (m³)	GROSS WEIGHT (kg)	SIZE (cm) ↓ ↓ ↓
16000A		10	0,097	14,58	35x12,5x22



Pierced plastic sieve for buckets

REF.	NOTES
P1190044U	for bucket 6 L
P1190050U	for bucket 4 L art. 0000SE0104



Plastic sieve for buckets 25 L

REF.	NOTES
21003	



Buckets and wringer trolleys



BUCKET/WRINGER
COMBOS

PLASTIC MOP
TROLLEYS

CHROMED AND RILSAN
COATED TROLLEYS

WRINGERS

MULTI-PURPOSE
BUCKETS

TOP-DOWN® BUCKETS

OTHER PLASTIC
BUCKETS

Transparent plastic cover

REF.	NOTES
60222	for bucket 4 L art. 0000SE0104
60232	for bucket 6 L
60230	for bucket 12 L



Transparent plastic cover with hinges

REF.	NOTES
0000CP1204T	for bucket 4 L art. 0000SE0104
0000CP1205T	for 4l bucket item no. 0000SE0204
0000CP1206T	for bucket 6 L



Hermetic transparent plastic cover for buckets 4 L art. 0000SE0104

REF.	NOTES
0000CP1104T	



Ideal for soaked cloths on a roll

Plastic divider for basket art. P1199900U - bucket support art. P220001E - buckets 4 L art. 0000SE0104

REF.	NOTES
P1909932U	





BUCKET/WRINGER
COMBOS

PLASTIC MOP
TROLLEYS

CHROMED AND RILSAN
COATED TROLLEYS

WRINGERS

MULTI-PURPOSE
BUCKETS

TOP-DOWN® BUCKETS

**OTHER PLASTIC
BUCKETS**

Plastic cover for bucket 28 L



REF.	NOTES	SIZE (cm) ↓ ↓ ↓
0000CP1128U		33x53x2,8

Wheel ø 35 mm



REF.	NOTES
2793	for Prisma, Twin, Top-Down®, Pick-Up, Trend and art. 0000SE1428

Wheel ø 50 mm



REF.	NOTES
7949	For King, Spider, Ro-cket Wheels, Duo Pro System, Prisma, Twin, Top-Down®, Pick-Up, Trend and code 0000SE1428

Multipurpose trolleys

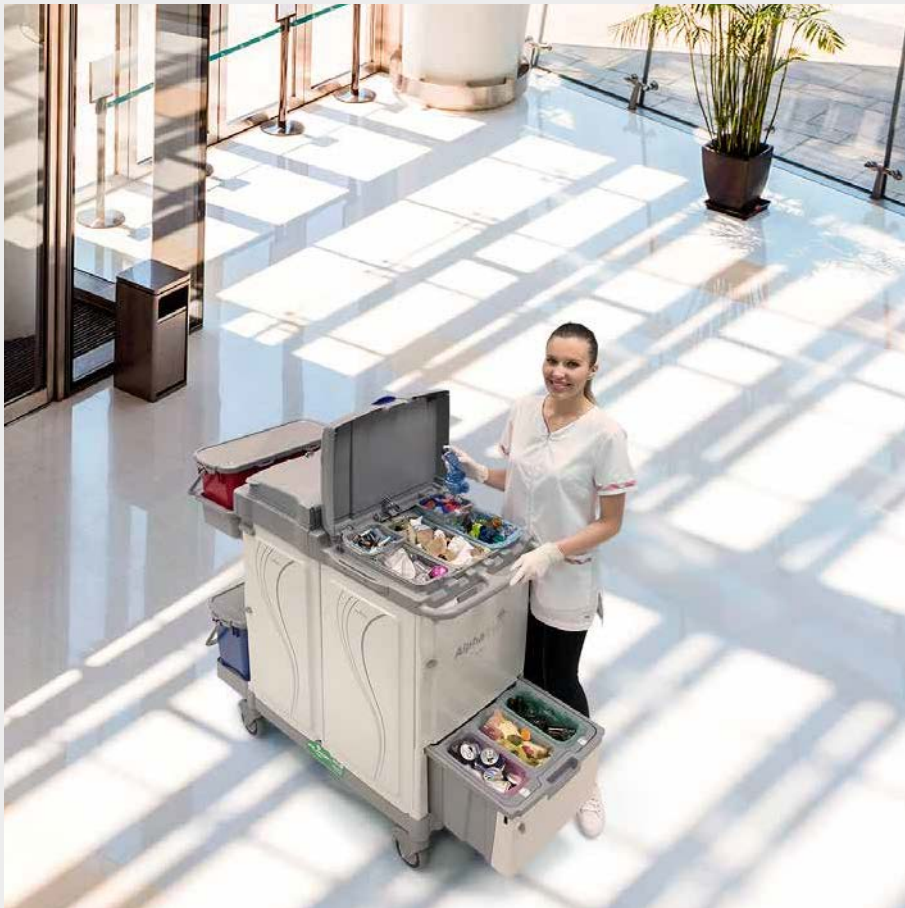

Alpha

Morgan

Chromed and Rilsan coated trolleys

MULTIPURPOSE
TROLLEYS





ALPHA

MORGAN

CHROMED AND RILSAN COATED TROLLEYS



MULTIPURPOSE
TROLLEYS



Alpha

COLLECTION AND STORAGE 226

WASHING 234

SOAKING 249

METAL FREE 266

DRIVE 267

Alpha is a complete range of **tailor-made multipurpose trolleys**, designed to **satisfy any cleaning need** thanks to the modularity of their components that can be combined with many accessories.

The available configurations are endless, from the most compact to the most complete version to satisfy any request in the best possible way.

Each trolley can be freely customized, having everything you need for a complete cleaning always at your fingertips.

Alpha trolleys are partly made of **plastic components certified "Plastic Second Life"**: an important choice that confirms the engagement to look for eco friendly solutions meant to **reduce the environmental impact** of the products, without giving up the **high quality standards**.



MULTIPURPOSE TROLLEYS



ALPHA

MORGAN

CHROMED AND RILSAN COATED TROLLEYS

A CUSTOMISED TROLLEY

The modularity characterizing the complete range and the wide assortment of accessories allow to **customize each part of the trolley** according to the specific needs and requirements.

The Alpha trolley line is characterized by an **extraordinary attention to details**, not only from the design point of view, but also from the aesthetic point of view.

Visually pleasing working tools can make the difference: thanks to their well-finished design and modern style Alpha trolleys are an **elegant solution to improve the offered standard service**.

Elegant trolleys thanks to their smooth lines and rounded edges **fitting any environment with their sobriety and simplicity**.



There is a **huge variety of customization possibilities**; discover all components and accessories at your disposal from page 269 onwards.



WASHING AREA

- Available with the **traditional wet mopping system with wringer**
- Top-Down buckets for **pre-soaking**
- Equodose for **soaking on demand**



ALPHA

MORGAN

CHROMED AND RILSAN COATED TROLLEYS

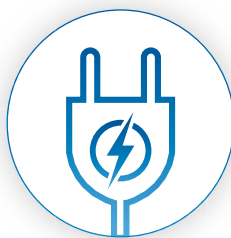

MOTOR-DRIVEN LINE

- Zero effort to protect the **health of the operator**
- **Manoeuvrability** on different surfaces as outdoor pavements and carpet
- Loading capacity up to **150 kg**
- Freedom of movement with **slopes up to 8%**



CUSTOMIZABLE GRAPHICS

- On request, doors and walls can be customized **with pictures, drawings, pictures and logo**
- Element perfectly **integrated in the surrounding area**
- Rolling **advertisement**
- Means of **communication**



180°



WASTE COLLECTION COMPARTMENT

- **Fixed or foldable** bagholder
- **Front or side** door
- **Standard or adjustable** push-grip



STORAGE COMPARTMENT

- Composed of **one or more units**
- **Open version or completely closed**
- Customizable with **buckets, drawers, shelves**, etc.



ALPHA

MORGAN

CHROMED AND RILSAN COATED TROLLEYS

Collection and storage

ALPHA 0101003 - plastic trolley



REF.	PCK	VOLUME (m³)	GROSS WEIGHT (kg)	SIZE (cm) ↓ ↓ ↓
MA0101003U000	1	0,177	13,66	75x58x102

0000SM00163	Set of T-shaped dark grey closing plugs for vertical frames (6 pcs)	1 pc.
0000SM00639	Uni-Move 2 handle holder kit	1 pc.
P059011U	Short base with wheels ø 100 mm	1 pc.
P1191100U	Side plastic basket	4 pcs
P1901112U	Plastic rising support for basket art. P1191100U	2 pcs
P2031102U	Vertical frame with reinforcement, 2 sides with T-plugs, complete with screws	1 pc.
P2909960U	Closing profile for vertical frame complete with screws and plugs	1 pc.

ON REQUEST, WITH SURCHARGE

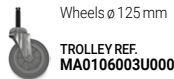

ALPHA 1100 - plastic trolley



REF.	PCK	VOLUME (m³)	GROSS WEIGHT (kg)	SIZE (cm) ↓ ↓ ↓
0000MA1100U00	1	0,177	13,01	75x58x102

0000SM00163	Set of T-shaped dark grey closing plugs for vertical frames (6 pcs)	1 pc.
P059011U	Short base with wheels ø 100 mm	1 pc.
P1191100U	Side plastic basket	2 pcs
P1909967U	Closing profile for bag holder 120 L	1 pc.
P2031103U	Vertical frame with reinforcement, 1 smooth side + 1 side for T-plugs, complete with screws	1 pc.
P8161111U	120L waste bag holder, male fitting, with dustpan hook and handle clip	1 pc.

ACCESSORIES TO BE ORDERED SEPARATELY

3650A	Blue plastic-coated bag 73x97 cm, maximum capacity 120 L	1 pc.
P291918A	Blue cover for bag holder 120 L	1 pc.

ON REQUEST, WITH SURCHARGE



Multipurpose trolleys



ALPHA

MORGAN

CHROMED AND RILSAN COATED TROLLEYS

ALPHA 1101 - plastic trolley



ALPHA 2101 - plastic trolley



REF.	PCK	VOLUME (m³)	GROSS WEIGHT (kg)	SIZE (cm) ↓ ↓ ↓
0000MA1101U00	1	0,177	13,11	75x58x111

0000SE0104A	Blue plastic bucket 4 L with plastic handle	1 pc.
0000SE0104A	Red plastic bucket 4 L with plastic handle	1 pc.
0000SM00163	Set of T-shaped dark grey closing plugs for vertical frames (6 pcs)	1 pc.
P059011U	Short base with wheels ø 100 mm	1 pc.
P1191100U	Side plastic basket	1 pc.
P2031103U	Vertical frame with reinforcement, 1 smooth side + 1 side for T-plugs, complete with screws	1 pc.
P8161112U	120l waste bag holder with tray, hooks, screws and plugs	1 pc.

⚠ ACCESSORIES TO BE ORDERED SEPARATELY

3650A	Blue plastic-coated bag 73x97 cm, maximum capacity 120 L	1 pc.
P291918A	Blue cover for bag holder 120 L	1 pc.

ON REQUEST, WITH SURCHARGE

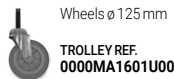

REF.	PCK	VOLUME (m³)	GROSS WEIGHT (kg)	SIZE (cm) ↓ ↓ ↓
0000MA2101U00	1	0,261	20,25	126x58x102

0000SM00165	Set of T-shaped light grey closing plugs for vertical frames (6 pcs)	2 pcs
P059011U	Short base with wheels ø 100 mm	1 pc.
P1229906U	Grey plastic drawer 22 L without key	1 pc.
P165000U	Base extension for Alpha trolleys and for the bag supporting plastic plate of the Morgan Hotel Elegance trolleys	1 pc.
P175000U	Supporting plastic plate for Alpha trolleys	1 pc.
P2039903E	Vertical frame, 1 side with slides + 1 side for T-plugs, complete with screws and plugs	2 pcs
P2199906U	Central plastic basket (female-female version) with plugs	1 pc.
P8161111U	120l waste bag holder, male fitting, with dustpan hook and handle clip	2 pcs

⚠ ACCESSORIES TO BE ORDERED SEPARATELY

3650A	Blue plastic-coated bag 73x97 cm, maximum capacity 120 L	1 pc.
3650B	Red plastified bag 73x97,5 cm, capacity 120 L	1 pc.
P291918A	Blue cover for bag holder 120 L	1 pc.
P291918B	Red cover for bag holder 120 L	1 pc.

ON REQUEST, WITH SURCHARGE



MULTIPURPOSE TROLLEYS



PRODUCT PARTIALLY MADE OF PLASTIC COMPONENTS CERTIFIED PSV - PLASTIC SECOND LIFE



ALPHA

MORGAN

CHROMED AND RILSAN COATED TROLLEYS

ALPHA 0001003 - plastic trolley



ALPHA 2103-14 - plastic trolley



REF.	PCK	VOLUME (m³)	GROSS WEIGHT (kg)	SIZE (cm) ↓ ↓ ↓
MA0001003U000	1	0,27	20,47	55x55x101

0000SM00165	Set of T-shaped light grey closing plugs for vertical frames (6 pcs)	2 pcs
0000SM00639	Uni-Move 2 handle holder kit	1 pc.
P025011U	Compact base with wheels ø 100 mm	1 pc.
P2039903E	Vertical frame, 1 side with slides + 1 side for T-plugs, complete with screws and plugs	2 pcs
P2199906U	Central plastic basket (female-female version) with plugs	1 pc.
P2229906U	Plastic drawer 22 L with lock	2 pcs
P2229907U	Plastic sliding drawer 40 L with locking key	1 pc.
P2909920U	Closing profile for central basket and central bag holder, with screws and plugs	1 pc.
P2909921U	Closing profile with push-grip for central basket and central bag holder complete with screws and plugs	1 pc.

ON REQUEST, WITH SURCHARGE

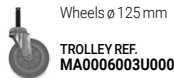

REF.	PCK	VOLUME (m³)	GROSS WEIGHT (kg)	SIZE (cm) ↓ ↓ ↓
0000MA2103U14	1	0,31	19,89	81x55x101

0000SM00165	Set of T-shaped light grey closing plugs for vertical frames (6 pcs)	2 pcs
0000SM00639	Uni-Move 2 handle holder kit	1 pc.
P059011U	Short base with wheels ø 100 mm	1 pc.
P1191100U	Side plastic basket	2 pcs
P1199900U	Upper basket	1 pc.
P2039903E	Vertical frame, 1 side with slides + 1 side for T-plugs, complete with screws and plugs	2 pcs
P2199907U	Central plastic basket (male-female version) with screws and plugs	1 pc.
P2229906U	Plastic drawer 22 L with lock	2 pcs
P2229907U	Plastic sliding drawer 40 L with locking key	1 pc.
P2909921U	Closing profile with push-grip for central basket and central bag holder complete with screws and plugs	1 pc.

ON REQUEST, WITH SURCHARGE

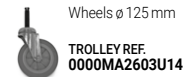

Multipurpose trolleys



ALPHA

MORGAN

CHROMED AND RILSAN COATED TROLLEYS

ALPHA 4101 - plastic trolley



ALPHA 5101 - plastic trolley



REF.	PCK	VOLUME (m³)	GROSS WEIGHT (kg)	SIZE (cm) ↓ ↓ ↓
0000MA4101U00	1	0,177	14,91	92x58x111

0000SE0104A	Blue plastic bucket 4 L with plastic handle	1 pc.
0000SE0104A	Red plastic bucket 4 L with plastic handle	1 pc.
0000SM00163	Set of T-shaped dark grey closing plugs for vertical frames (6 pcs)	1 pc.
P066011U	Long base with wheels ø 100 mm	1 pc.
P1191100U	Side plastic basket	1 pc.
P2031103U	Vertical frame with reinforcement, 1 smooth side + 1 side for T-plugs, complete with screws	1 pc.
P8161112U	120L waste bag holder with tray, hooks, screws and plugs	1 pc.

⚠ ACCESSORIES TO BE ORDERED SEPARATELY

3650A	Blue plastic-coated bag 73x97 cm, maximum capacity 120 L	1 pc.
P291918A	Blue cover for bag holder 120 L	1 pc.

ON REQUEST, WITH SURCHARGE

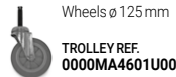

REF.	PCK	VOLUME (m³)	GROSS WEIGHT (kg)	SIZE (cm) ↓ ↓ ↓
0000MA5101U00	1	0,261	18,05	92x58x114

0000SE0104A	Blue plastic bucket 4 L with plastic handle	1 pc.
0000SE0104A	Red plastic bucket 4 L with plastic handle	1 pc.
0000SE0104C	Yellow plastic bucket 4 L with plastic handle	1 pc.
0000SE0104F	Green plastic bucket 4 L with plastic handle	1 pc.
0000SM00165	Set of T-shaped light grey closing plugs for vertical frames (6 pcs)	2 pcs
3048	Set of 3 stickers for buckets	1 pc.
P066011U	Long base with wheels ø 100 mm	1 pc.
P1229906U	Grey plastic drawer 22 L without key	1 pc.
P2039903E	Vertical frame, 1 side with slides + 1 side for T-plugs, complete with screws and plugs	2 pcs
P2199906U	Central plastic basket (female-female version) with plugs	1 pc.
P2909920U	Closing profile for central basket and central bag holder, with screws and plugs	1 pc.
P8161111U	120L waste bag holder, male fitting, with dustpan hook and handle clip	1 pc.

⚠ ACCESSORIES TO BE ORDERED SEPARATELY

3650A	Blue plastic-coated bag 73x97 cm, maximum capacity 120 L	1 pc.
P291918A	Blue cover for bag holder 120 L	1 pc.

ON REQUEST, WITH SURCHARGE





ALPHA

MORGAN

CHROMED AND RILSAN COATED TROLLEYS

ALPHA 5113-01 - plastic trolley



ALPHA 6105 - plastic trolley



REF.	PCK	VOLUME (m³)	GROSS WEIGHT (kg)	SIZE (cm) ↓ ↓ ↓
0000MA5113U01	1	0,261	21,45	104x55x101

0000SM00165	Set of T-shaped light grey closing plugs for vertical frames (6 pcs)	2 pcs
0000SM00639	Uni-Move 2 handle holder kit	1 pc.
P066011U	Long base with wheels ø 100 mm	1 pc.
P1229906U	Grey plastic drawer 22 L without key	2 pcs
P2039903E	Vertical frame, 1 side with slides + 1 side for T-plugs, complete with screws and plugs	2 pcs
P2039904E	Vertical frame, 2 sides with slides, complete with screws and plugs	1 pc.
P2199906U	Central plastic basket (female-female version) with plugs	1 pc.
P2199907U	Central plastic basket (male-female version) with screws and plugs	1 pc.
P2909921U	Closing profile with push-grip for central basket and central bag holder complete with screws and plugs	2 pcs

ON REQUEST, WITH SURCHARGE

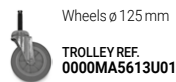

REF.	PCK	VOLUME (m³)	GROSS WEIGHT (kg)	SIZE (cm) ↓ ↓ ↓
0000MA6105U00	1	0,261	22,05	133x58x102

0000SM00165	Set of T-shaped light grey closing plugs for vertical frames (6 pcs)	2 pcs
P066011U	Long base with wheels ø 100 mm	1 pc.
P1229906U	Grey plastic drawer 22 L without key	1 pc.
P175000U	Supporting plastic plate for Alpha trolleys	1 pc.
P2039903E	Vertical frame, 1 side with slides + 1 side for T-plugs, complete with screws and plugs	2 pcs
P2199906U	Central plastic basket (female-female version) with plugs	1 pc.
P3059953E	Fixed side wall with fixing pins	1 pc.
P3059954E	Right door with fixing pins	1 pc.
P8161111U	120L waste bag holder, male fitting, with dustpan hook and handle clip	2 pcs

ACCESSORIES TO BE ORDERED SEPARATELY

3650A	Blue plastic-coated bag 73x97 cm, maximum capacity 120 L	1 pc.
3650B	Red plastified bag 73x97,5 cm, capacity 120 L	1 pc.
P291918A	Blue cover for bag holder 120 L	1 pc.
P291918B	Red cover for bag holder 120 L	1 pc.

ON REQUEST, WITH SURCHARGE

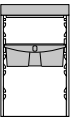
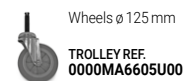



ALPHA

MORGAN

CHROMED AND RILSAN COATED TROLLEYS

ALPHA 0001101 - plastic trolley with Split system



REF.	PCK	VOLUME (m³)	GROSS WEIGHT (kg)	SIZE (cm)
MA0001101U000	1	0,291	23,62	56x54x104

0000SE0204UA	Grey plastic bucket 4 L with blue upper plastic handle	1 pc.
0000SE0204UB	Grey plastic bucket 4 L with red upper plastic handle	1 pc.
0000SM00165	Set of T-shaped light grey closing plugs for vertical frames (6 pcs)	1 pc.
I1050072	Stainless steel holder for 4 lt buckets to be applied to 150 lt bag holder	1 pc.
P025011U	Compact base with wheels ø 100 mm	1 pc.
P1909968U	Covering for bag holder 150L, foldable bag holder 120L and closing profiles	1 pc.
P2039906E	Vertical Frame, 1 smooth side + 1 side for T-plugs, complete with screws and plugs	1 pc.
P2059963E	Door for Alpha bag holder with Split system	1 pc.
P2229913U	33L plastic drawer with lock for Alpha with Split system	1 pc.
P2229914U	Removable plastic shelf for Alpha with Split system	1 pc.
P2909912U	Divider for bag holder 150 L	1 pc.
P2909946A	Blue cover for bag holder 150 L with check list holder	1 pc.
P3059967E	Set walls, right and left, for Alpha with Split system	1 pc.
P8169905U	150-liter bag holder for Alpha standard and 90-liter for Alpha with Split system, male version, with hooks, pistons, screws and plugs	1 pc.

⚠ ACCESSORIES TO BE ORDERED SEPARATELY

0000AT0310A	Blue plastified bag 45 L, 32x23x63 cm	1 pc.
P2909915U	Pedal kit for Alpha trolleys with large, mini or supporting plate, 150 lt bag holder and ø 100 mm wheels	1 pc.

ON REQUEST, WITH SURCHARGE

Rubber wheels ø 125 mm TROLLEY REF. MA0003101U000	Wheels ø 125 mm TROLLEY REF. MA0006101U000	Bag holder with adjustable push-grip TROLLEY REF. MA0001151U000
--	---	--

ALPHA 3301000 - plastic trolley

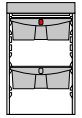
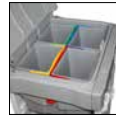

REF.	PCK	VOLUME (m³)	GROSS WEIGHT (kg)	SIZE (cm)
MA3301000U000	1	0,27	25,47	97x58x110

Trolley dimensions with closed foldable bag holder 66x58x145 cm

0000SE0204UA	Grey plastic bucket 4 L with blue upper plastic handle	1 pc.
0000SE0204UB	Grey plastic bucket 4 L with red upper plastic handle	1 pc.
0000SE0204UC	Grey plastic bucket 4 L with yellow upper plastic handle	1 pc.
0000SE0204UF	Grey plastic bucket 4 L with green upper plastic handle	1 pc.
0000SM00165	Set of T-shaped light grey closing plugs for vertical frames (6 pcs)	2 pcs
3048	Set of 3 stickers for buckets	1 pc.
P059011U	Short base with wheels ø 100 mm	1 pc.
P1229906U	Grey plastic drawer 22 L without key	1 pc.
P165000U	Base extension for Alpha trolleys and for the bag supporting plastic plate of the Morgan Hotel Elegance trolleys	1 pc.
P1909937U	Plastic lift for buckets, with holes for bottles, fitting drawers 22 and 40 L	1 pc.
P2039903E	Vertical frame, 1 side with slides + 1 side for T-plugs, complete with screws and plugs	2 pcs
P2229906U	Plastic drawer 22 L with lock	1 pc.
P2909920U	Closing profile for central basket and central bag holder, with screws and plugs	1 pc.
P3059953E	Fixed side wall with fixing pins	1 pc.
P3059954E	Right door with fixing pins	1 pc.
P3199903U	Central ring for 4 l buckets complete with lockable grey lid and 2 pistons	1 pc.
P8161115U	Folding 120l waste bag holder with deep fitting, with bag retaining hooks, dustpan hook, handle clip, screws and plugs	1 pc.

⚠ ACCESSORIES TO BE ORDERED SEPARATELY

3650A	Blue plastic-coated bag 73x97 cm, maximum capacity 120 L	1 pc.
P291918A	Blue cover for bag holder 120 L	1 pc.

ON REQUEST, WITH SURCHARGE

Rubber wheels ø 125 mm TROLLEY REF. MA3303000U000	Wheels ø 125 mm TROLLEY REF. MA3306000U000
--	---





ALPHA

MORGAN

CHROMED AND RILSAN COATED TROLLEYS

ALPHA 0301002 - plastic trolley



REF.	PCK	VOLUME (m³)	GROSS WEIGHT (kg)	SIZE (cm) ↓ ↓ ↓
MA0301002U000	1	0,224	19,31	58x81x102

0000SM00165	Set of T-shaped light grey closing plugs for vertical frames (6 pcs)	1 pc.
P059011U	Short base with wheels ø 100 mm	1 pc.
P1191100U	Side plastic basket	1 pc.
P1199900U	Upper basket	1 pc.
P2039903E	Vertical frame, 1 side with slides + 1 side for T-plugs, complete with screws and plugs	1 pc.
P2909912U	Divider for bag holder 150 L	1 pc.
P2909946A	Blue cover for bag holder 150 L with check list holder	1 pc.
P3059953E	Fixed side wall with fixing pins	2 pcs
P3909952E	Door with fixing pins for bag holder	1 pc.
P8169905U	150-liter bag holder for Alpha standard and 90-liter for Alpha with Split system, male version, with hooks, pistons, screws and plugs	1 pc.

⚠ ACCESSORIES TO BE ORDERED SEPARATELY

0000AT0160A	Plastified bag 56x92 cm, capacity 80 L, blu	1 pc.
0000AT0160B	Plastified bag 56x92 cm, capacity 80 L, red	1 pc.
P3909915U	Pedal set for Alpha trolleys with short base, bag holder 150 L and wheels ø 100 mm	1 pc.

ON REQUEST, WITH SURCHARGE

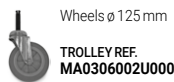

ALPHA 8100 - plastic trolley



REF.	PCK	VOLUME (m³)	GROSS WEIGHT (kg)	SIZE (cm) ↓ ↓ ↓
2000MA8100U00	1	0,31	25,38	98x58x102

0000SM00165	Set of T-shaped light grey closing plugs for vertical frames (6 pcs)	2 pcs
P066011U	Long base with wheels ø 100 mm	1 pc.
P1229906U	Grey plastic drawer 22 L without key	1 pc.
P2039903E	Vertical frame, 1 side with slides + 1 side for T-plugs, complete with screws and plugs	2 pcs
P2199906U	Central plastic basket (female-female version) with plugs	1 pc.
P2909912U	Divider for bag holder 150 L	1 pc.
P2909920U	Closing profile for central basket and central bag holder, with screws and plugs	1 pc.
P2909946A	Blue cover for bag holder 150 L with check list holder	1 pc.
P3059953E	Fixed side wall with fixing pins	3 pcs
P3059954E	Right door with fixing pins	1 pc.
P3909952E	Door with fixing pins for bag holder	1 pc.
P8169905U	150-liter bag holder for Alpha standard and 90-liter for Alpha with Split system, male version, with hooks, pistons, screws and plugs	1 pc.

⚠ ACCESSORIES TO BE ORDERED SEPARATELY

0000AT0160A	Plastified bag 56x92 cm, capacity 80 L, blu	1 pc.
0000AT0160B	Plastified bag 56x92 cm, capacity 80 L, red	1 pc.
P2909915U	Pedal kit for Alpha trolleys with large, mini or supporting plate, 150 lt bag holder and ø 100 mm wheels	1 pc.

ON REQUEST, WITH SURCHARGE





ALPHA

MORGAN

CHROMED AND RILSAN COATED TROLLEYS

ALPHA 3801000- plastic trolley

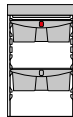
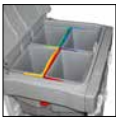



REF.	PCK	VOLUME (m³)	GROSS WEIGHT (kg)	SIZE (cm)
MA3801000U001	1	0,372	29,47	124x58x110

0000SE0204UA	Grey plastic bucket 4 L with blue upper plastic handle	1 pc.
0000SE0204UB	Grey plastic bucket 4 L with red upper plastic handle	1 pc.
0000SE0204UC	Grey plastic bucket 4 L with yellow upper plastic handle	1 pc.
0000SE0204UF	Grey plastic bucket 4 L with green upper plastic handle	1 pc.
0000SM00165	Set of T-shaped light grey closing plugs for vertical frames (6 pcs)	2 pcs
3048	Set of 3 stickers for buckets	1 pc.
P066011U	Long base with wheels ø 100 mm	1 pc.
P1191100U	Side plastic basket	2 pcs
P1229906U	Grey plastic drawer 22 L without key	1 pc.
P1909937U	Plastic lift for buckets, with holes for bottles, fitting drawers 22 and 40 L	1 pc.
P2039903E	Vertical frame, 1 side with slides + 1 side for T-plugs, complete with screws and plugs	2 pcs
P2229906U	Plastic drawer 22 L with lock	1 pc.
P2909912U	Divider for bag holder 150 L	1 pc.
P2909920U	Closing profile for central basket and central bag holder, with screws and plugs	1 pc.
P2909946A	Blue cover for bag holder 150 L with check list holder	1 pc.
P3059953E	Fixed side wall with fixing pins	3 pcs
P3059954E	Right door with fixing pins	1 pc.
P3199903U	Central ring for 4 l buckets complete with lockable grey lid and 2 pistons	1 pc.
P3909952E	Door with fixing pins for bag holder	1 pc.
P8169905U	150-liter bag holder for Alpha standard and 90-liter for Alpha with Split system, male version, with hooks, pistons, screws and plugs	1 pc.

ACCESSORIES TO BE ORDERED SEPARATELY

0000AT0160A	Plastified bag 56x92 cm, capacity 80 L, blu	1 pc.
0000AT0160B	Plastified bag 56x92 cm, capacity 80 L, red	1 pc.
P2909915U	Pedal kit for Alpha trolleys with large, mini or supporting plate, 150 lt bag holder and ø 100 mm wheels	1 pc.

ON REQUEST, WITH SURCHARGE

	Rubber wheels ø 125 mm TROLLEY REF. MA3803000U001		Wheels ø 125 mm TROLLEY REF. MA3806000U001		Bag holder with adjustable push-grip TROLLEY REF. MA3801050U001
--	--	---	---	---	--

ALPHA 0601019 - plastic trolley

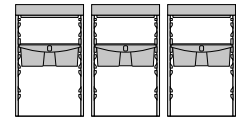

REF.	PCK	VOLUME (m³)	GROSS WEIGHT (kg)	SIZE (cm)
MA0601019U000	1	0,488	35,24	146x58x101

0000SM00165	Set of T-shaped light grey closing plugs for vertical frames (6 pcs)	2 pcs
0000SM00639	Uni-Move 2 handle holder kit	1 pc.
P066011U	Long base with wheels ø 100 mm	1 pc.
P1229906U	Grey plastic drawer 22 L without key	3 pcs
P2039903E	Vertical frame, 1 side with slides + 1 side for T-plugs, complete with screws and plugs	2 pcs
P2039904E	Vertical frame, 2 sides with slides, complete with screws and plugs	2 pcs
P2199906U	Central plastic basket (female-female version) with plugs	1 pc.
P2199907U	Central plastic basket (male-female version) with screws and plugs	2 pcs
P2909921U	Closing profile with push-grip for central basket and central bag holder complete with screws and plugs	2 pcs
P3059953E	Fixed side wall with fixing pins	3 pcs
P3059954E	Right door with fixing pins	2 pcs
P3059974E	Left door with fixing pins	1 pc.
P515010U	Supporting plate with 2 wheels ø 100 mm and 2 blocking pins	1 pc.

ON REQUEST, WITH SURCHARGE

	Rubber wheels ø 125 mm TROLLEY REF. MA0603019U000		Wheels ø 125 mm TROLLEY REF. MA0606019U000
---	--	---	---





ALPHA

MORGAN

CHROMED AND RILSAN COATED TROLLEYS

Washing

ALPHA 1104 - plastic trolley



ALPHA 1105 - plastic trolley



REF.	PCK	VOLUME (m³)	GROSS WEIGHT (kg)	SIZE (cm) ↓ ↓ ↓
0000MA1104U00	1	0,261	19,04	97x68x111

0000SE0104A	Blue plastic bucket 4 L with plastic handle	1 pc.
0000SE0104A	Red plastic bucket 4 L with plastic handle	1 pc.
0000SM00163	Set of T-shaped dark grey closing plugs for vertical frames (6 pcs)	1 pc.
7004A	REGULAR - blue plastic down-press wringer with plastic gears	1 pc.
8108A	Blue plastic bucket 15 L with plastic handle	1 pc.
8108B	Red plastic bucket 15 L with plastic handle	1 pc.
P059011U	Short base with wheels ø 100 mm	1 pc.
P165000U	Base extension for Alpha trolleys and for the bag supporting plastic plate of the Morgan Hotel Elegance trolleys	1 pc.
P2031103U	Vertical frame with reinforcement, 1 smooth side + 1 side for T-plugs, complete with screws	1 pc.
P8161112U	120l waste bag holder with tray, hooks, screws and plugs	1 pc.
R1040010	Rilsan coated wringer support complete with screws	1 pc.

ACCESSORIES TO BE ORDERED SEPARATELY

3650A	Blue plastic-coated bag 73x97 cm, maximum capacity 120 L	1 pc.
P291918A	Blue cover for bag holder 120 L	1 pc.

ON REQUEST, WITH SURCHARGE

	Rubber wheels ø 125 mm TROLLEY REF. 0000MA1304U00		Wheels ø 125 mm TROLLEY REF. 0000MA1604U00		Foldable bag holder 120 L TROLLEY REF. 0300MA1104U00
--	--	---	---	---	---



REF.	PCK	VOLUME (m³)	GROSS WEIGHT (kg)	SIZE (cm) ↓ ↓ ↓
0000MA1105U00	1	0,322	22,02	97x58x111

0000SE0104A	Blue plastic bucket 4 L with plastic handle	1 pc.
0000SE0104A	Red plastic bucket 4 L with plastic handle	1 pc.
0000SL2700C	JUMPY - single shockproof plastic bucket 30 L	1 pc.
0000SM00163	Set of T-shaped dark grey closing plugs for vertical frames (6 pcs)	1 pc.
P059011U	Short base with wheels ø 100 mm	1 pc.
P165000U	Base extension for Alpha trolleys and for the bag supporting plastic plate of the Morgan Hotel Elegance trolleys	1 pc.
P2031103U	Vertical frame with reinforcement, 1 smooth side + 1 side for T-plugs, complete with screws	1 pc.
P8161112U	120l waste bag holder with tray, hooks, screws and plugs	1 pc.

ACCESSORIES TO BE ORDERED SEPARATELY

3650A	Blue plastic-coated bag 73x97 cm, maximum capacity 120 L	1 pc.
P291918A	Blue cover for bag holder 120 L	1 pc.

ON REQUEST, WITH SURCHARGE

	Rubber wheels ø 125 mm TROLLEY REF. 0000MA1305U00		Wheels ø 125 mm TROLLEY REF. 0000MA1605U00		Foldable bag holder 120 L TROLLEY REF. 0300MA1105U00
---	--	---	---	---	---





ALPHA

MORGAN

CHROMED AND RILSAN COATED TROLLEYS

ALPHA 0101406 - plastic trolley



ALPHA 0001000 - plastic trolley



REF.	PCK	VOLUME (m³)	GROSS WEIGHT (kg)	SIZE (cm) ↓ ↓ ↓
MA0101406U000	1	0,293	18,9	83x56x111

0000SE0104A	Blue plastic bucket 4 L with plastic handle	1 pc.
0000SE0104A	Red plastic bucket 4 L with plastic handle	1 pc.
0000SM00100U	Handle holder fitting basket cod. 60402A and bucket holder cod. P220001E	1 pc.
0000SM00163	Set of T-shaped dark grey closing plugs for vertical frames (6 pcs)	1 pc.
0020SE2742U	Kit Duo Pro - 25l mop bucket, 17l mop bucket, Duo Pro lever-operated wringer, extension for base and bucket holder	1 pc.
P059011U	Short base with wheels ø 100 mm	1 pc.
P1199900U	Upper basket	1 pc.
P2031102U	Vertical frame with reinforcement, 2 sides with T-plugs, complete with screws	1 pc.
P2909921U	Closing profile with push-grip for central basket and central bag holder complete with screws and plugs	1 pc.
R2060031	Rilsan 70l waste bag holder	1 pc.

⚠ ACCESSORIES TO BE ORDERED SEPARATELY

0000AT0160A	Plastified bag 56x92 cm, capacity 80 L, blu	1 pc.
P190916A	Plastic lid for 70l waste bag holder	1 pc.

ON REQUEST, WITH SURCHARGE

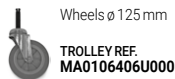

REF.	PCK	VOLUME (m³)	GROSS WEIGHT (kg)	SIZE (cm) ↓ ↓ ↓
MA0001000U000	1	0,177	12,91	55x55x102

Complete trolley sizes with OneFred 122x65x102 cm

0000SM00163	Set of T-shaped dark grey closing plugs for vertical frames (6 pcs)	1 pc.
P025011U	Compact base with wheels ø 100 mm	1 pc.
P1909967U	Closing profile for bag holder 120 L	1 pc.
P2031103U	Vertical frame with reinforcement, 1 smooth side + 1 side for T-plugs, complete with screws	1 pc.
P8161111U	120l waste bag holder, male fitting, with dustpan hook and handle clip	1 pc.

⚠ ACCESSORIES TO BE ORDERED SEPARATELY

0000LF0031YU	ONEFRED - 30l plastic trolley with plastic handle, tray and broom holder	1 pc.
0000SM00301	PEG KIT - OneFred attachment kit for Alpha trolleys	1 pc.
3650A	Blue plastic-coated bag 73x97 cm, maximum capacity 120 L	1 pc.
P291918A	Blue cover for bag holder 120 L	1 pc.

ON REQUEST, WITH SURCHARGE





ALPHA

MORGAN

CHROMED AND RILSAN COATED TROLLEYS

ALPHA 4103 - plastic trolley



ALPHA 0401405 - plastic trolley



REF.	PCK	VOLUME (m³)	GROSS WEIGHT (kg)	SIZE (cm) ↓ ↓ ↓
0000MA4103U00	1	0,261	18,64	92x68x111

0000SE0104A	Blue plastic bucket 4 L with plastic handle	1 pc.
0000SE0104A	Red plastic bucket 4 L with plastic handle	1 pc.
0000SM00163	Set of T-shaped dark grey closing plugs for vertical frames (6 pcs)	1 pc.
7004A	REGULAR - blue plastic down-press wringer with plastic gears	1 pc.
8108A	Blue plastic bucket 15 L with plastic handle	1 pc.
8108B	Red plastic bucket 15 L with plastic handle	1 pc.
P066011U	Long base with wheels ø 100 mm	1 pc.
P2031103U	Vertical frame with reinforcement, 1 smooth side + 1 side for T-plugs, complete with screws	1 pc.
P8161112U	120l waste bag holder with tray, hooks, screws and plugs	1 pc.
R1040010	Rilsan coated wringer support complete with screws	1 pc.

⚠ ACCESSORIES TO BE ORDERED SEPARATELY

3650A	Blue plastic-coated bag 73x97 cm, maximum capacity 120 L	1 pc.
P291918A	Blue cover for bag holder 120 L	1 pc.

ON REQUEST, WITH SURCHARGE

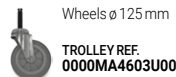

REF.	PCK	VOLUME (m³)	GROSS WEIGHT (kg)	SIZE (cm) ↓ ↓ ↓
MA0401405U000	1	0,293	20,9	95x56x111

0000SE0104A	Blue plastic bucket 4 L with plastic handle	1 pc.
0000SE0104A	Red plastic bucket 4 L with plastic handle	1 pc.
0000SM00122U	Handle holder fitting baskets cod. P1191100U and Morgan trolleys	1 pc.
0000SM00163	Set of T-shaped dark grey closing plugs for vertical frames (6 pcs)	1 pc.
0020SE2742U	Kit Duo Pro - 25l mop bucket, 17l mop bucket, Duo Pro lever-operated wringer, extension for base and bucket holder	1 pc.
P066011U	Long base with wheels ø 100 mm	1 pc.
P2031103U	Vertical frame with reinforcement, 1 smooth side + 1 side for T-plugs, complete with screws	1 pc.
P8161112U	120l waste bag holder with tray, hooks, screws and plugs	1 pc.

⚠ ACCESSORIES TO BE ORDERED SEPARATELY

3650A	Blue plastic-coated bag 73x97 cm, maximum capacity 120 L	1 pc.
P291918A	Blue cover for bag holder 120 L	1 pc.

ON REQUEST, WITH SURCHARGE



Multipurpose trolleys



ALPHA

MORGAN

CHROMED AND RILSAN COATED TROLLEYS

ALPHA 0401402 - plastic trolley



ALPHA 5107 - plastic trolley



REF.	PCK	VOLUME (m³)	GROSS WEIGHT (kg)	SIZE (cm) ↓ ↓ ↓
MA0401402U000	1	0,372	23,45	102x68x111

0000SE0104A	Blue plastic bucket 4 L with plastic handle	1 pc.
0000SE0104A	Red plastic bucket 4 L with plastic handle	1 pc.
0000SM00163	Set of T-shaped dark grey closing plugs for vertical frames (6 pcs)	2 pcs
0000SM00610	Assembling kit to fix Handy bin to Alpha vertical frame	1 pc.
0000SM00639	Uni-Move 2 handle holder kit	1 pc.
7004A	REGULAR - blue plastic down-press wringer with plastic gears	1 pc.
8108A	Blue plastic bucket 15 L with plastic handle	1 pc.
8108B	Red plastic bucket 15 L with plastic handle	1 pc.
P066011U	Long base with wheels ø 100 mm	1 pc.
P1199900U	Upper basket	1 pc.
P2031102U	Vertical frame with reinforcement, 2 sides with T-plugs, complete with screws	1 pc.
P2909920U	Closing profile for central basket and central bag holder, with screws and plugs	1 pc.
P391070E	HANDY - bin 70 L with drain plug, wheels, bag stretcher and grip	1 pc.
R1040010	Rilsan coated wringer support complete with screws	1 pc.

ON REQUEST, WITH SURCHARGE

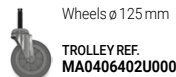

REF.	PCK	VOLUME (m³)	GROSS WEIGHT (kg)	SIZE (cm) ↓ ↓ ↓
0000MA5107U00	1	0,372	25,46	133x68x120

0000SM00165	Set of T-shaped light grey closing plugs for vertical frames (6 pcs)	2 pcs
7004A	REGULAR - blue plastic down-press wringer with plastic gears	1 pc.
8108A	Blue plastic bucket 15 L with plastic handle	1 pc.
8108B	Red plastic bucket 15 L with plastic handle	1 pc.
8211/1A	Blue plastic bucket 12 L with plastic handle	1 pc.
8211/1B	Red plastic bucket 12 L with plastic handle	1 pc.
P066011U	Long base with wheels ø 100 mm	1 pc.
P1229906U	Grey plastic drawer 22 L without key	1 pc.
P175000U	Supporting plastic plate for Alpha trolleys	1 pc.
P2039903E	Vertical frame, 1 side with slides + 1 side for T-plugs, complete with screws and plugs	2 pcs
P2199906U	Central plastic basket (female-female version) with plugs	1 pc.
P2909920U	Closing profile for central basket and central bag holder, with screws and plugs	1 pc.
P8161111U	120l waste bag holder, male fitting, with dustpan hook and handle clip	1 pc.
R1040010	Rilsan coated wringer support complete with screws	1 pc.

⚠ ACCESSORIES TO BE ORDERED SEPARATELY

3650A	Blue plastic-coated bag 73x97 cm, maximum capacity 120 L	1 pc.
P291918A	Blue cover for bag holder 120 L	1 pc.

ON REQUEST, WITH SURCHARGE





ALPHA

MORGAN

CHROMED AND RILSAN COATED TROLLEYS

ALPHA 5108-18 - plastic trolley



ALPHA 0501415 - plastic trolley



REF.	PCK	VOLUME (m³)	GROSS WEIGHT (kg)	SIZE (cm) ↓ ↓ ↓
0000MA5108U18	1	0,372	27,46	133x68x114

0000SE0104A	Blue plastic bucket 4 L with plastic handle	1 pc.
0000SE0104A	Red plastic bucket 4 L with plastic handle	1 pc.
0000SE0104C	Yellow plastic bucket 4 L with plastic handle	1 pc.
0000SE0104F	Green plastic bucket 4 L with plastic handle	1 pc.
0000SM00165	Set of T-shaped light grey closing plugs for vertical frames (6 pcs)	2 pcs
3048	Set of 3 stickers for buckets	1 pc.
7004A	REGULAR - blue plastic down-press wringer with plastic gears	1 pc.
8108A	Blue plastic bucket 15 L with plastic handle	1 pc.
8108B	Red plastic bucket 15 L with plastic handle	1 pc.
P066011U	Long base with wheels ø 100 mm	1 pc.
P1229906U	Grey plastic drawer 22 L without key	1 pc.
P175000U	Supporting plastic plate for Alpha trolleys	1 pc.
P2039903E	Vertical frame, 1 side with slides + 1 side for T-plugs, complete with screws and plugs	2 pcs
P2199906U	Central plastic basket (female-female version) with plugs	1 pc.
P2229907U	Plastic sliding drawer 40 L with locking key	1 pc.
P2909920U	Closing profile for central basket and central bag holder, with screws and plugs	1 pc.
P8161111U	120l waste bag holder, male fitting, with dustpan hook and handle clip	1 pc.
R1040010	Rilsan coated wringer support complete with screws	1 pc.

⚠ ACCESSORIES TO BE ORDERED SEPARATELY

3650A	Blue plastic-coated bag 73x97 cm, maximum capacity 120 L	1 pc.
P291918A	Blue cover for bag holder 120 L	1 pc.

ON REQUEST, WITH SURCHARGE

	Rubber wheels ø 125 mm TROLLEY REF. 0000MA5308U18		Wheels ø 125 mm TROLLEY REF. 0000MA5608U18		Foldable bag holder 120 L TROLLEY REF. 0300MA5108U18
--	---	--	--	--	--

REF.	PCK	VOLUME (m³)	GROSS WEIGHT (kg)	SIZE (cm) ↓ ↓ ↓
MA0501415U000	1	0,488	28,27	139x56x114

0000SE0104A	Blue plastic bucket 4 L with plastic handle	1 pc.
0000SE0104A	Red plastic bucket 4 L with plastic handle	1 pc.
0000SE0104C	Yellow plastic bucket 4 L with plastic handle	1 pc.
0000SE0104F	Green plastic bucket 4 L with plastic handle	1 pc.
0000SM00165	Set of T-shaped light grey closing plugs for vertical frames (6 pcs)	2 pcs
0020SE2742U	Kit Duo Pro - 25l mop bucket, 17l mop bucket, Duo Pro lever-operated wringer, extension for base and bucket holder	1 pc.
3048	Set of 3 stickers for buckets	1 pc.
P066011U	Long base with wheels ø 100 mm	1 pc.
P1229906U	Grey plastic drawer 22 L without key	1 pc.
P175000U	Supporting plastic plate for Alpha trolleys	1 pc.
P2039903E	Vertical frame, 1 side with slides + 1 side for T-plugs, complete with screws and plugs	2 pcs
P2199906U	Central plastic basket (female-female version) with plugs	1 pc.
P2229907U	Plastic sliding drawer 40 L with locking key	1 pc.
P2909920U	Closing profile for central basket and central bag holder, with screws and plugs	1 pc.
P8161111U	120l waste bag holder, male fitting, with dustpan hook and handle clip	1 pc.

⚠ ACCESSORIES TO BE ORDERED SEPARATELY

3650A	Blue plastic-coated bag 73x97 cm, maximum capacity 120 L	1 pc.
P291918A	Blue cover for bag holder 120 L	1 pc.

ON REQUEST, WITH SURCHARGE

	Rubber wheels ø 125 mm TROLLEY REF. MA0503415U000		Wheels ø 125 mm TROLLEY REF. MA0506415U000		Foldable bag holder 120 L TROLLEY REF. MA0501415U001
--	---	--	--	--	--



Multipurpose trolleys



ALPHA

MORGAN

CHROMED AND RILSAN COATED TROLLEYS

ALPHA 0201000 - plastic trolley



OneFred
NOT INCLUDED



ALPHA 5110 - plastic trolley



REF.	PCK	VOLUME (m³)	GROSS WEIGHT (kg)	SIZE (cm) ↓ ↓ ↓
MA0201000U000	1	0,261	18,81	97x58x114

REF.	PCK	VOLUME (m³)	GROSS WEIGHT (kg)	SIZE (cm) ↓ ↓ ↓
0000MA5110U00	1	0,4	28,62	133x69x114

Trolley dimensions with closed foldable bag holder 66x58x145 cm - Complete trolley sizes with OneFred 160x65x114 cm

0000SE0104A	Blue plastic bucket 4 L with plastic handle	1 pc.
0000SE0104A	Red plastic bucket 4 L with plastic handle	1 pc.
0000SE0104C	Yellow plastic bucket 4 L with plastic handle	1 pc.
0000SE0104F	Green plastic bucket 4 L with plastic handle	1 pc.
0000SM00165	Set of T-shaped light grey closing plugs for vertical frames (6 pcs)	2 pcs
3048	Set of 3 stickers for buckets	1 pc.
P059011U	Short base with wheels ø 100 mm	1 pc.
P1229906U	Grey plastic drawer 22 L without key	1 pc.
P165000U	Base extension for Alpha trolleys and for the bag supporting plastic plate of the Morgan Hotel Elegance trolleys	1 pc.
P2039903E	Vertical frame, 1 side with slides + 1 side for T-plugs, complete with screws and plugs	2 pcs
P2199906U	Central plastic basket (female-female version) with plugs	1 pc.
P2909920U	Closing profile for central basket and central bag holder, with screws and plugs	1 pc.
P8161113U	Folding 120l waste bag holder, with bag retaining hooks, dustpan hook, handle clip, screws and plugs	1 pc.

0000SE0104A	Blue plastic bucket 4 L with plastic handle	1 pc.
0000SE0104A	Red plastic bucket 4 L with plastic handle	1 pc.
0000SE0104C	Yellow plastic bucket 4 L with plastic handle	1 pc.
0000SE0104F	Green plastic bucket 4 L with plastic handle	1 pc.
0000SM00165	Set of T-shaped light grey closing plugs for vertical frames (6 pcs)	2 pcs
0000SM00606	Rilsan coated fixing set for Fred trolley	1 pc.
3048	Set of 3 stickers for buckets	1 pc.
7960A/P	FRED - plastic trolley 30 L with plastic grip	1 pc.
P066011U	Long base with wheels ø 100 mm	1 pc.
P1229906U	Grey plastic drawer 22 L without key	1 pc.
P175000U	Supporting plastic plate for Alpha trolleys	1 pc.
P2039903E	Vertical frame, 1 side with slides + 1 side for T-plugs, complete with screws and plugs	2 pcs
P2199906U	Central plastic basket (female-female version) with plugs	1 pc.
P2909920U	Closing profile for central basket and central bag holder, with screws and plugs	1 pc.
P8161111U	120l waste bag holder, male fitting, with dustpan hook and handle clip	1 pc.

⚠ ACCESSORIES TO BE ORDERED SEPARATELY

0000LF0031YU	ONEFRED - 30 l plastic trolley with plastic handle, tray and broom holder	1 pc.
0000SM00301	PEG KIT - OneFred attachment kit for Alpha trolleys	1 pc.
3650A	Blue plastic-coated bag 73x97 cm, maximum capacity 120 L	1 pc.
P291918A	Blue cover for bag holder 120 L	1 pc.

⚠ ACCESSORIES TO BE ORDERED SEPARATELY

3650A	Blue plastic-coated bag 73x97 cm, maximum capacity 120 L	1 pc.
P291918A	Blue cover for bag holder 120 L	1 pc.

ON REQUEST, WITH SURCHARGE

	Rubber wheels ø 125 mm TROLLEY REF. MA0203000U000		Wheels ø 125 mm TROLLEY REF. MA0206000U000
--	--	--	---

ON REQUEST, WITH SURCHARGE

	Rubber wheels ø 125 mm TROLLEY REF. 0000MA5310U00		Wheels ø 125 mm TROLLEY REF. 0000MA5610U00		Foldable bag holder 120 L TROLLEY REF. 0300MA5110U00
--	--	--	---	--	---

MULTIPURPOSE TROLLEYS



PRODUCT PARTIALLY MADE OF PLASTIC COMPONENTS CERTIFIED PSV - PLASTIC SECOND LIFE



ALPHA

MORGAN

CHROMED AND RILSAN COATED TROLLEYS

ALPHA 5601416 - plastic trolley

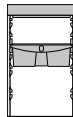

REF.	PCK	VOLUME (m³)	GROSS WEIGHT (kg)	SIZE (cm)
MA5601416U000	1	0,372	27,47	133x68x114

0000SE0104A	Blue plastic bucket 4 L with plastic handle	1 pc.
0000SE0104A	Red plastic bucket 4 L with plastic handle	1 pc.
0000SM00165	Set of T-shaped light grey closing plugs for vertical frames (6 pcs)	2 pcs
7004A	REGULAR - blue plastic down-press wringer with plastic gears	1 pc.
8108A	Blue plastic bucket 15 L with plastic handle	1 pc.
8108B	Red plastic bucket 15 L with plastic handle	1 pc.
P066011U	Long base with wheels ø 100 mm	1 pc.
P1229906U	Grey plastic drawer 22 L without key	1 pc.
P175000U	Supporting plastic plate for Alpha trolleys	1 pc.
P2039903E	Vertical frame, 1 side with slides + 1 side for T-plugs, complete with screws and plugs	2 pcs
P2199927UT	Central basket (male-female version) with divider, transparent cover, screws and plugs	1 pc.
P2909920U	Closing profile for central basket and central bag holder, with screws and plugs	1 pc.
P3059953E	Fixed side wall with fixing pins	1 pc.
P3059954E	Right door with fixing pins	1 pc.
P8161111U	120l waste bag holder, male fitting, with dustpan hook and handle clip	1 pc.
R1040010	Rilsan coated wringer support complete with screws	1 pc.

⚠ ACCESSORIES TO BE ORDERED SEPARATELY

3650A	Blue plastic-coated bag 73x97 cm, maximum capacity 120 L	1 pc.
P291918A	Blue cover for bag holder 120 L	1 pc.

ON REQUEST, WITH SURCHARGE

Rubber wheels ø 125 mm TROLLEY REF. MA5603416U000	Wheels ø 125 mm TROLLEY REF. MA5606416U000	Foldable bag holder 120 L TROLLEY REF. MA5601416U001
--	---	---

ALPHA 6103 - plastic trolley

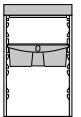

REF.	PCK	VOLUME (m³)	GROSS WEIGHT (kg)	SIZE (cm)
0000MA6103U00	1	0,372	28,06	133x68x114

0000SE0104A	Blue plastic bucket 4 L with plastic handle	1 pc.
0000SE0104A	Red plastic bucket 4 L with plastic handle	1 pc.
0000SE0104C	Yellow plastic bucket 4 L with plastic handle	1 pc.
0000SE0104F	Green plastic bucket 4 L with plastic handle	1 pc.
0000SM00165	Set of T-shaped light grey closing plugs for vertical frames (6 pcs)	2 pcs
3048	Set of 3 stickers for buckets	1 pc.
7004A	REGULAR - blue plastic down-press wringer with plastic gears	1 pc.
8108A	Blue plastic bucket 15 L with plastic handle	1 pc.
8108B	Red plastic bucket 15 L with plastic handle	1 pc.
P066011U	Long base with wheels ø 100 mm	1 pc.
P1199900U	Upper basket	1 pc.
P1229906U	Grey plastic drawer 22 L without key	1 pc.
P175000U	Supporting plastic plate for Alpha trolleys	1 pc.
P2039903E	Vertical frame, 1 side with slides + 1 side for T-plugs, complete with screws and plugs	2 pcs
P2199907U	Central plastic basket (male-female version) with screws and plugs	1 pc.
P3059953E	Fixed side wall with fixing pins	1 pc.
P3059954E	Right door with fixing pins	1 pc.
P8161111U	120l waste bag holder, male fitting, with dustpan hook and handle clip	1 pc.
R1040010	Rilsan coated wringer support complete with screws	1 pc.

⚠ ACCESSORIES TO BE ORDERED SEPARATELY

3650A	Blue plastic-coated bag 73x97 cm, maximum capacity 120 L	1 pc.
P291918A	Blue cover for bag holder 120 L	1 pc.

ON REQUEST, WITH SURCHARGE

Rubber wheels ø 125 mm TROLLEY REF. 0000MA6303U00	Wheels ø 125 mm TROLLEY REF. 0000MA6603U00	Foldable bag holder 120 L TROLLEY REF. 0300MA6103U00
--	---	---



Multipurpose trolleys



ALPHA

MORGAN

CHROMED AND RILSAN COATED TROLLEYS

ALPHA 3601400 - plastic trolley

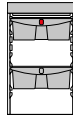
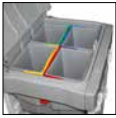

REF.	PCK	VOLUME (m³)	GROSS WEIGHT (kg)	SIZE (cm)
MA3601400U000	1	0,372	30,37	133x68x110

Trolley dimensions with closed foldable bag holder 100x68x145 cm

0000SE0204UA	Grey plastic bucket 4 L with blue upper plastic handle	1 pc.
0000SE0204UB	Grey plastic bucket 4 L with red upper plastic handle	1 pc.
0000SE0204UC	Grey plastic bucket 4 L with yellow upper plastic handle	1 pc.
0000SE0204UF	Grey plastic bucket 4 L with green upper plastic handle	1 pc.
0000SM00165	Set of T-shaped light grey closing plugs for vertical frames (6 pcs)	2 pcs
3048	Set of 3 stickers for buckets	1 pc.
7004A	REGULAR - blue plastic down-press wringer with plastic gears	1 pc.
8108A	Blue plastic bucket 15 L with plastic handle	1 pc.
8108B	Red plastic bucket 15 L with plastic handle	1 pc.
P066011U	Long base with wheels ø 100 mm	1 pc.
P1229906U	Grey plastic drawer 22 L without key	1 pc.
P175000U	Supporting plastic plate for Alpha trolleys	1 pc.
P1909937U	Plastic lift for buckets, with holes for bottles, fitting drawers 22 and 40 L	1 pc.
P2039903E	Vertical frame, 1 side with slides + 1 side for T-plugs, complete with screws and plugs	2 pcs
P2229906U	Plastic drawer 22 L with lock	1 pc.
P2909920U	Closing profile for central basket and central bag holder, with screws and plugs	1 pc.
P3059953E	Fixed side wall with fixing pins	1 pc.
P3059954E	Right door with fixing pins	1 pc.
P3199903U	Central ring for 4 l buckets complete with lockable grey lid and 2 pistons	1 pc.
P8161115U	Folding 120l waste bag holder with deep fitting, with bag retaining hooks, dustpan hook, handle clip, screws and plugs	1 pc.
R1040010	Rilsan coated wringer support complete with screws	1 pc.

⚠ ACCESSORIES TO BE ORDERED SEPARATELY

3650A	Blue plastic-coated bag 73x97 cm, maximum capacity 120 L	1 pc.
P291918A	Blue cover for bag holder 120 L	1 pc.

ON REQUEST, WITH SURCHARGE

	Rubber wheels ø 125 mm TROLLEY REF. MA3603400U000		Wheels ø 125 mm TROLLEY REF. MA3606400U000
--	--	---	---

ALPHA 4601400 - plastic trolley

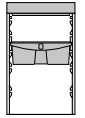

REF.	PCK	VOLUME (m³)	GROSS WEIGHT (kg)	SIZE (cm)
MA4601400U000	1	0,372	28,24	133x68x110

Trolley dimensions with closed foldable bag holder 100x68x145 cm

0000SE0108A	Blue plastic bucket 8 L with plastic handle	1 pc.
0000SE0108B	Red plastic bucket 8 L with plastic handle	1 pc.
0000SE0108C	Yellow plastic bucket 8 L with plastic handle	1 pc.
0000SM00165	Set of T-shaped light grey closing plugs for vertical frames (6 pcs)	2 pcs
7004A	REGULAR - blue plastic down-press wringer with plastic gears	1 pc.
8108A	Blue plastic bucket 15 L with plastic handle	1 pc.
8108B	Red plastic bucket 15 L with plastic handle	1 pc.
P066011U	Long base with wheels ø 100 mm	1 pc.
P1229906U	Grey plastic drawer 22 L without key	1 pc.
P175000U	Supporting plastic plate for Alpha trolleys	1 pc.
P2039903E	Vertical frame, 1 side with slides + 1 side for T-plugs, complete with screws and plugs	2 pcs
P2909920U	Closing profile for central basket and central bag holder, with screws and plugs	1 pc.
P3059953E	Fixed side wall with fixing pins	1 pc.
P3059954E	Right door with fixing pins	1 pc.
P3199905U	Central plastic frame with grey cover with locking key and 2 shock absorbing pistons for versions with 3 hanging buckets 8 L	1 pc.
P8161115U	Folding 120l waste bag holder with deep fitting, with bag retaining hooks, dustpan hook, handle clip, screws and plugs	1 pc.
R1040010	Rilsan coated wringer support complete with screws	1 pc.

⚠ ACCESSORIES TO BE ORDERED SEPARATELY

3650A	Blue plastic-coated bag 73x97 cm, maximum capacity 120 L	1 pc.
P291918A	Blue cover for bag holder 120 L	1 pc.

ON REQUEST, WITH SURCHARGE

	Rubber wheels ø 125 mm TROLLEY REF. MA4603400U000		Wheels ø 125 mm TROLLEY REF. MA4606400U000
---	--	---	---





ALPHA

MORGAN

CHROMED AND RILSAN COATED TROLLEYS

ALPHA MR0601400 - plastic trolley with Link-Up system

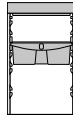

REF.	PCK	VOLUME (m³)	GROSS WEIGHT (kg)	SIZE (cm) ↓ ↓ ↓
MR0601400U17	1	0,487	40,36	153x68x114

0000SE0104A	Blue plastic bucket 4 L with plastic handle	1 pc.
0000SE0104A	Red plastic bucket 4 L with plastic handle	1 pc.
0000SE0104C	Yellow plastic bucket 4 L with plastic handle	1 pc.
0000SE0104F	Green plastic bucket 4 L with plastic handle	1 pc.
0000SM00165	Set of T-shaped light grey closing plugs for vertical frames (6 pcs)	2 pcs
0000SM00617	Quick connection kit Link-Up (4 pcs)	1 pc.
3048	Set of 3 stickers for buckets	1 pc.
7004A	REGULAR - blue plastic down-press wringer with plastic gears	1 pc.
8108A	Blue plastic bucket 15 L with plastic handle	1 pc.
8108B	Red plastic bucket 15 L with plastic handle	1 pc.
P025011U	Compact base with wheels ø 100 mm	1 pc.
P066011U	Long base with wheels ø 100 mm	1 pc.
P1229906U	Grey plastic drawer 22 L without key	1 pc.
P1909967U	Closing profile for bag holder 120 L	1 pc.
P2031103U	Vertical frame with reinforcement, 1 smooth side + 1 side for T-plugs, complete with screws	1 pc.
P2039903E	Vertical frame, 1 side with slides + 1 side for T-plugs, complete with screws and plugs	2 pcs
P2199906U	Central plastic basket (female-female version) with plugs	1 pc.
P2909920U	Closing profile for central basket and central bag holder, with screws and plugs	1 pc.
P2909921U	Closing profile with push-grip for central basket and central bag holder complete with screws and plugs	1 pc.
P3059953E	Fixed side wall with fixing pins	1 pc.
P3059954E	Right door with fixing pins	1 pc.
P8161111U	120l waste bag holder, male fitting, with dustpan hook and handle clip	1 pc.
R1040010	Rilsan coated wringer support complete with screws	1 pc.

ACCESSORIES TO BE ORDERED SEPARATELY

3650A	Blue plastic-coated bag 73x97 cm, maximum capacity 120 L	1 pc.
P291918A	Blue cover for bag holder 120 L	1 pc.

ON REQUEST, WITH SURCHARGE

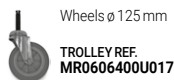

ALPHA 7101 - plastic trolley



REF.	PCK	VOLUME (m³)	GROSS WEIGHT (kg)	SIZE (cm) ↓ ↓ ↓
2000MA7101U00	1	0,31	22,08	98x68x111

0000SE0104A	Blue plastic bucket 4 L with plastic handle	1 pc.
0000SE0104A	Red plastic bucket 4 L with plastic handle	1 pc.
0000SM00165	Set of T-shaped light grey closing plugs for vertical frames (6 pcs)	1 pc.
7004A	REGULAR - blue plastic down-press wringer with plastic gears	1 pc.
8108A	Blue plastic bucket 15 L with plastic handle	1 pc.
8108B	Red plastic bucket 15 L with plastic handle	1 pc.
P066011U	Long base with wheels ø 100 mm	1 pc.
P1199900U	Upper basket	1 pc.
P2039903E	Vertical frame, 1 side with slides + 1 side for T-plugs, complete with screws and plugs	1 pc.
P2909912U	Divider for bag holder 150 L	1 pc.
P2909946A	Blue cover for bag holder 150 L with check list holder	1 pc.
P3059953E	Fixed side wall with fixing pins	2 pcs
P3909952E	Door with fixing pins for bag holder	1 pc.
P8169905U	150-liter bag holder for Alpha standard and 90-liter for Alpha with Split system, male version, with hooks, pistons, screws and plugs	1 pc.
R1040010	Rilsan coated wringer support complete with screws	1 pc.

ACCESSORIES TO BE ORDERED SEPARATELY

0000AT0160A	Plastified bag 56x92 cm, capacity 80 L, blu	1 pc.
0000AT0160B	Plastified bag 56x92 cm, capacity 80 L, red	1 pc.
P2909915U	Pedal kit for Alpha trolleys with large, mini or supporting plate, 150 l bag holder and ø 100 mm wheels	1 pc.

ON REQUEST, WITH SURCHARGE



Multipurpose trolleys



ALPHA

MORGAN

CHROMED AND RILSAN COATED TROLLEYS

ALPHA 0701500 - plastic trolley with Split system



REF.	PCK	VOLUME (m³)	GROSS WEIGHT (kg)	SIZE (cm) ↓ ↓ ↓
MA0701500U000	1	0,372	29,37	98x68x111

0000SE0104A	Blue plastic bucket 4 L with plastic handle	1 pc.
0000SE0104A	Red plastic bucket 4 L with plastic handle	1 pc.
0000SM00165	Set of T-shaped light grey closing plugs for vertical frames (6 pcs)	1 pc.
7004A	REGULAR - blue plastic down-press wringer with plastic gears	1 pc.
8108A	Blue plastic bucket 15 L with plastic handle	1 pc.
8108B	Red plastic bucket 15 L with plastic handle	1 pc.
P066011U	Long base with wheels ø 100 mm	1 pc.
P1199900U	Upper basket	1 pc.
P2039906E	Vertical Frame, 1 smooth side + 1 side for T-plugs, complete with screws and plugs	1 pc.
P2059963E	Door for Alpha bag holder with Split system	1 pc.
P2229913U	33L plastic drawer with lock for Alpha with Split system	1 pc.
P2229914U	Removable plastic shelf for Alpha with Split system	1 pc.
P2909912U	Divider for bag holder 150 L	1 pc.
P2909946A	Blue cover for bag holder 150 L with check list holder	1 pc.
P3059967E	Set walls, right and left, for Alpha with Split system	1 pc.
P8169905U	150-liter bag holder for Alpha standard and 90-liter for Alpha with Split system, male version, with hooks, pistons, screws and plugs	1 pc.
R1040010	Rilsan coated wringer support complete with screws	1 pc.

ACCESSORIES TO BE ORDERED SEPARATELY

0000AT0310A	Blue plastified bag 45 L, 32x23x63 cm	1 pc.
0000AT0310B	Red plastified bag 45 L, 32x23x63 cm	1 pc.
P2909915U	Pedal kit for Alpha trolleys with large, mini or supporting plate, 150 lt bag holder and ø 100 mm wheels	1 pc.

ON REQUEST, WITH SURCHARGE

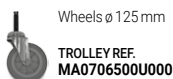

ALPHA 0701450 - carrello in plastica



REF.	PCK	VOLUME (m³)	GROSS WEIGHT (kg)	SIZE (cm) ↓ ↓ ↓
MA0701450U000	1	0,372	22,94	108x68x111

0000SE0104A	Blue plastic bucket 4 L with plastic handle	1 pc.
0000SE0104A	Red plastic bucket 4 L with plastic handle	1 pc.
0000SM00165	Set of T-shaped light grey closing plugs for vertical frames (6 pcs)	1 pc.
7004A	REGULAR - blue plastic down-press wringer with plastic gears	1 pc.
8108A	Blue plastic bucket 15 L with plastic handle	1 pc.
8108B	Red plastic bucket 15 L with plastic handle	1 pc.
P066011U	Long base with wheels ø 100 mm	1 pc.
P1199900U	Upper basket	1 pc.
P2039903E	Vertical frame, 1 side with slides + 1 side for T-plugs, complete with screws and plugs	1 pc.
P2909912U	Divider for bag holder 150 L	1 pc.
P2909946A	Blue cover for bag holder 150 L with check list holder	1 pc.
P3059953E	Fixed side wall with fixing pins	2 pcs
P3909952E	Door with fixing pins for bag holder	1 pc.
P8269907U	150l waste bag holder for Alpha standard and 90l for Alpha with Split system, with adjustable push handle, male fitting, with hooks, pistons, screws and plugs	1 pc.
R1040010	Rilsan coated wringer support complete with screws	1 pc.

ACCESSORIES TO BE ORDERED SEPARATELY

0000AT0160A	Plastified bag 56x92 cm, capacity 80 L, blu	1 pc.
0000AT0160B	Plastified bag 56x92 cm, capacity 80 L, red	1 pc.
P2909915U	Pedal kit for Alpha trolleys with large, mini or supporting plate, 150 lt bag holder and ø 100 mm wheels	1 pc.

ON REQUEST, WITH SURCHARGE



MULTIPURPOSE TROLLEYS



PRODUCT PARTIALLY MADE OF PLASTIC COMPONENTS CERTIFIED PSV - PLASTIC SECOND LIFE



ALPHA

MORGAN

CHROMED AND RILSAN COATED TROLLEYS

ALPHA 0701404 - plastic trolley



ALPHA 8104 - plastic trolley



REF.	PCK	VOLUME (m³)	GROSS WEIGHT (kg)	SIZE (cm) ↓ ↓ ↓
MA0701404U000	1	0,34	25,95	106x56x111

0000SE0104A	Blue plastic bucket 4 L with plastic handle	1 pc.
0000SE0104A	Red plastic bucket 4 L with plastic handle	1 pc.
0000SM00100U	Handle holder fitting basket cod. 60402A and bucket holder cod. P220001E	1 pc.
0000SM00165	Set of T-shaped light grey closing plugs for vertical frames (6 pcs)	1 pc.
0020SE2742U	Kit Duo Pro - 25l mop bucket, 17l mop bucket, Duo Pro lever-operated wringer, extension for base and bucket holder	1 pc.
P066011U	Long base with wheels ø 100 mm	1 pc.
P1199900U	Upper basket	1 pc.
P2039903E	Vertical frame, 1 side with slides + 1 side for T-plugs, complete with screws and plugs	1 pc.
P2909912U	Divider for bag holder 150 L	1 pc.
P2909946A	Blue cover for bag holder 150 L with check list holder	1 pc.
P3059953E	Fixed side wall with fixing pins	2 pcs
P3909952E	Door with fixing pins for bag holder	1 pc.
P8169905U	150-liter bag holder for Alpha standard and 90-liter for Alpha with Split system, male version, with hooks, pistons, screws and plugs	1 pc.

⚠ ACCESSORIES TO BE ORDERED SEPARATELY

0000AT0160A	Plastified bag 56x92 cm, capacity 80 L, blu	1 pc.
0000AT0160B	Plastified bag 56x92 cm, capacity 80 L, red	1 pc.
P2909915U	Pedal kit for Alpha trolleys with large, mini or supporting plate, 150 lt bag holder and ø 100 mm wheels	1 pc.

ON REQUEST, WITH SURCHARGE

	Rubber wheels ø 125 mm TROLLEY REF. MA0703404U000		Wheels ø 125 mm TROLLEY REF. MA0706404U000		Bag holder with adjustable push-grip TROLLEY REF. MA0701454U000
--	---	--	--	--	---

REF.	PCK	VOLUME (m³)	GROSS WEIGHT (kg)	SIZE (cm) ↓ ↓ ↓
1000MA8104U00	1	0,406	34,64	139x68x114

0000SE0104A	Blue plastic bucket 4 L with plastic handle	1 pc.
0000SE0104A	Red plastic bucket 4 L with plastic handle	1 pc.
0000SE0104C	Yellow plastic bucket 4 L with plastic handle	1 pc.
0000SE0104F	Green plastic bucket 4 L with plastic handle	1 pc.
0000SM00165	Set of T-shaped light grey closing plugs for vertical frames (6 pcs)	2 pcs
3048	Set of 3 stickers for buckets	1 pc.
7004A	REGULAR - blue plastic down-press wringer with plastic gears	1 pc.
8108A	Blue plastic bucket 15 L with plastic handle	1 pc.
8108B	Red plastic bucket 15 L with plastic handle	1 pc.
P066011U	Long base with wheels ø 100 mm	1 pc.
P1229906U	Grey plastic drawer 22 L without key	1 pc.
P2039903E	Vertical frame, 1 side with slides + 1 side for T-plugs, complete with screws and plugs	2 pcs
P2199906U	Central plastic basket (female-female version) with plugs	1 pc.
P2909912U	Divider for bag holder 150 L	1 pc.
P2909920U	Closing profile for central basket and central bag holder, with screws and plugs	1 pc.
P2909946A	Blue cover for bag holder 150 L with check list holder	1 pc.
P3059953E	Fixed side wall with fixing pins	3 pcs
P3059954E	Right door with fixing pins	1 pc.
P3909952E	Door with fixing pins for bag holder	1 pc.
P515010U	Supporting plate with 2 wheels ø 100 mm and 2 blocking pins	1 pc.
P8169905U	150-liter bag holder for Alpha standard and 90-liter for Alpha with Split system, male version, with hooks, pistons, screws and plugs	1 pc.
R1040010	Rilsan coated wringer support complete with screws	1 pc.

⚠ ACCESSORIES TO BE ORDERED SEPARATELY

0000AT0160A	Plastified bag 56x92 cm, capacity 80 L, blu	1 pc.
0000AT0160B	Plastified bag 56x92 cm, capacity 80 L, red	1 pc.
P2909915U	Pedal kit for Alpha trolleys with large, mini or supporting plate, 150 lt bag holder and ø 100 mm wheels	1 pc.

ON REQUEST, WITH SURCHARGE

	Rubber wheels ø 125 mm TROLLEY REF. 1000MA8304U00		Wheels ø 125 mm TROLLEY REF. 1000MA8604U00		Bag holder with adjustable push-grip TROLLEY REF. MA0801450U000
--	---	--	--	--	---



Multipurpose trolleys



ALPHA

MORGAN

CHROMED AND RILSAN COATED TROLLEYS

ALPHA MR3801400 - plastic trolley with Link-Up system

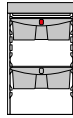
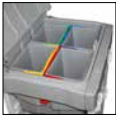

REF.	PCK	VOLUME (m³)	GROSS WEIGHT (kg)	SIZE (cm)
MR3801400U000	1	0,177	47,2	155x68x110

0000SE0204UA	Grey plastic bucket 4 L with blue upper plastic handle	1 pc.
0000SE0204UB	Grey plastic bucket 4 L with red upper plastic handle	1 pc.
0000SE0204UC	Grey plastic bucket 4 L with yellow upper plastic handle	1 pc.
0000SE0204UF	Grey plastic bucket 4 L with green upper plastic handle	1 pc.
0000SM00165	Set of T-shaped light grey closing plugs for vertical frames (6 pcs)	2 pcs
0000SM00617	Quick connection kit Link-Up (4 pcs)	1 pc.
3048	Set of 3 stickers for buckets	1 pc.
7004A	REGULAR - blue plastic down-press wringer with plastic gears	1 pc.
8108A	Blue plastic bucket 15 L with plastic handle	1 pc.
8108B	Red plastic bucket 15 L with plastic handle	1 pc.
P025011U	Compact base with wheels ø 100 mm	1 pc.
P066011U	Long base with wheels ø 100 mm	1 pc.
P1229906U	Grey plastic drawer 22 L without key	1 pc.
P1909937U	Plastic lift for buckets, with holes for bottles, fitting drawers 22 and 40 L	1 pc.
P1909968U	Covering for bag holder 150L, foldable bag holder 120L and closing profiles	1 pc.
P2039903E	Vertical frame, 1 side with slides + 1 side for T-plugs, complete with screws and plugs	3 pcs
P2229906U	Plastic drawer 22 L with lock	1 pc.
P2909912U	Divider for bag holder 150 L	1 pc.
P2909920U	Closing profile for central basket and central bag holder, with screws and plugs	1 pc.
P2909921U	Closing profile with push-grip for central basket and central bag holder complete with screws and plugs	1 pc.
P2909946A	Blue cover for bag holder 150 L with check list holder	1 pc.
P3059953E	Fixed side wall with fixing pins	3 pcs
P3059954E	Right door with fixing pins	1 pc.
P3199903U	Central ring for 4 l buckets complete with lockable grey lid and 2 pistons	1 pc.
P3909952E	Door with fixing pins for bag holder	1 pc.
P8169905U	150-liter bag holder for Alpha standard and 90-liter for Alpha with Split system, male version, with hooks, pistons, screws and plugs	1 pc.
R1040010	Rilsan coated wringer support complete with screws	1 pc.

⚠ ACCESSORIES TO BE ORDERED SEPARATELY

0000AT0160A	Plastified bag 56x92 cm, capacity 80 L, blu	1 pc.
0000AT0160B	Plastified bag 56x92 cm, capacity 80 L, red	1 pc.
P2909915U	Pedal kit for Alpha trolleys with large, mini or supporting plate, 150 lt bag holder and ø 100 mm wheels	1 pc.

ON REQUEST, WITH SURCHARGE

	Rubber wheels ø 125 mm TROLLEY REF. MR3803400U000		Wheels ø 125 mm TROLLEY REF. MR3806400U000		Bag holder with adjustable push-grip TROLLEY REF. MR3801450U000
--	--	--	---	--	--

ALPHA 5801408 - plastic trolley

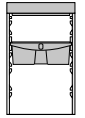

REF.	PCK	VOLUME (m³)	GROSS WEIGHT (kg)	SIZE (cm)
MA5801408U000	1	0,406	34,97	139x68x111

0000SE0104A	Blue plastic bucket 4 L with plastic handle	1 pc.
0000SE0104A	Red plastic bucket 4 L with plastic handle	1 pc.
0000SM00165	Set of T-shaped light grey closing plugs for vertical frames (6 pcs)	2 pcs
7004A	REGULAR - blue plastic down-press wringer with plastic gears	1 pc.
8108A	Blue plastic bucket 15 L with plastic handle	1 pc.
8108B	Red plastic bucket 15 L with plastic handle	1 pc.
P066011U	Long base with wheels ø 100 mm	1 pc.
P1199900U	Upper basket	1 pc.
P1229906U	Grey plastic drawer 22 L without key	1 pc.
P2039903E	Vertical frame, 1 side with slides + 1 side for T-plugs, complete with screws and plugs	2 pcs
P2199936U	Central basket (female-female version) with divider, two grey covers and plugs	1 pc.
P2909912U	Divider for bag holder 150 L	1 pc.
P2909946A	Blue cover for bag holder 150 L with check list holder	1 pc.
P3059953E	Fixed side wall with fixing pins	3 pcs
P3059954E	Right door with fixing pins	1 pc.
P3909952E	Door with fixing pins for bag holder	1 pc.
P515010U	Supporting plate with 2 wheels ø 100 mm and 2 blocking pins	1 pc.
P8169905U	150-liter bag holder for Alpha standard and 90-liter for Alpha with Split system, male version, with hooks, pistons, screws and plugs	1 pc.
R1040010	Rilsan coated wringer support complete with screws	1 pc.

⚠ ACCESSORIES TO BE ORDERED SEPARATELY

0000AT0160A	Plastified bag 56x92 cm, capacity 80 L, blu	1 pc.
0000AT0160B	Plastified bag 56x92 cm, capacity 80 L, red	1 pc.
P2909915U	Pedal kit for Alpha trolleys with large, mini or supporting plate, 150 lt bag holder and ø 100 mm wheels	1 pc.

ON REQUEST, WITH SURCHARGE

	Rubber wheels ø 125 mm TROLLEY REF. MA5803408U000		Wheels ø 125 mm TROLLEY REF. MA5806408U000		Bag holder with adjustable push-grip TROLLEY REF. MA5801458U000
--	--	--	---	--	--



PRODUCT PARTIALLY MADE OF PLASTIC COMPONENTS CERTIFIED PSV - PLASTIC SECOND LIFE



ALPHA

MORGAN

CHROMED AND RILSAN COATED TROLLEYS

ALPHA 0801407 - plastic trolley

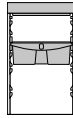

ALPHA 3801400 - plastic trolley

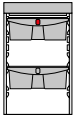
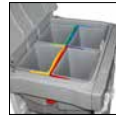

REF.	PCK	VOLUME (m³)	GROSS WEIGHT (kg)	SIZE (cm)
MA0801407U000	1	0,406	33,97	145x56x114

0000SE0104A	Blue plastic bucket 4 L with plastic handle	1 pc.
0000SE0104A	Red plastic bucket 4 L with plastic handle	1 pc.
0000SE0104C	Yellow plastic bucket 4 L with plastic handle	1 pc.
0000SE0104F	Green plastic bucket 4 L with plastic handle	1 pc.
0000SM00165	Set of T-shaped light grey closing plugs for vertical frames (6 pcs)	2 pcs
0020SE2742U	Kit Duo Pro - 25l mop bucket, 17l mop bucket, Duo Pro lever-operated wringer, extension for base and bucket holder	1 pc.
3048	Set of 3 stickers for buckets	1 pc.
P066011U	Long base with wheels ø 100 mm	1 pc.
P1229906U	Grey plastic drawer 22 L without key	1 pc.
P2039903E	Vertical frame, 1 side with slides + 1 side for T-plugs, complete with screws and plugs	2 pcs
P2199906U	Central plastic basket (female-female version) with plugs	1 pc.
P2909912U	Divider for bag holder 150 L	1 pc.
P2909920U	Closing profile for central basket and central bag holder, with screws and plugs	1 pc.
P2909946A	Blue cover for bag holder 150 L with check list holder	1 pc.
P3059953E	Fixed side wall with fixing pins	3 pcs
P3059954E	Right door with fixing pins	1 pc.
P3909952E	Door with fixing pins for bag holder	1 pc.
P515010U	Supporting plate with 2 wheels ø 100 mm and 2 blocking pins	1 pc.
P8169905U	150-liter bag holder for Alpha standard and 90-liter for Alpha with Split system, male version, with hooks, pistons, screws and plugs	1 pc.

⚠ ACCESSORIES TO BE ORDERED SEPARATELY

0000AT0160A	Plastified bag 56x92 cm, capacity 80 L, blu	1 pc.
0000AT0160B	Plastified bag 56x92 cm, capacity 80 L, red	1 pc.
P2909915U	Pedal kit for Alpha trolleys with large, mini or supporting plate, 150 lt bag holder and ø 100 mm wheels	1 pc.

ON REQUEST, WITH SURCHARGE

	Rubber wheels ø 125 mm TROLLEY REF. MA0803407U000		Wheels ø 125 mm TROLLEY REF. MA0806407U000		Bag holder with adjustable push-grip TROLLEY REF. MA0801457U000
--	---	--	--	--	---

REF.	PCK	VOLUME (m³)	GROSS WEIGHT (kg)	SIZE (cm)
MA3801400U002	1	0,455	36,93	139x68x110

0000SE0204UA	Grey plastic bucket 4 L with blue upper plastic handle	1 pc.
0000SE0204UB	Grey plastic bucket 4 L with red upper plastic handle	1 pc.
0000SE0204UC	Grey plastic bucket 4 L with yellow upper plastic handle	1 pc.
0000SE0204UF	Grey plastic bucket 4 L with green upper plastic handle	1 pc.
0000SM00165	Set of T-shaped light grey closing plugs for vertical frames (6 pcs)	2 pcs
3048	Set of 3 stickers for buckets	1 pc.
7004A	REGULAR - blue plastic down-press wringer with plastic gears	1 pc.
8108A	Blue plastic bucket 15 L with plastic handle	1 pc.
8108B	Red plastic bucket 15 L with plastic handle	1 pc.
P066011U	Long base with wheels ø 100 mm	1 pc.
P1229906U	Grey plastic drawer 22 L without key	1 pc.
P1909937U	Plastic lift for buckets, with holes for bottles, fitting drawers 22 and 40 L	1 pc.
P2039903E	Vertical frame, 1 side with slides + 1 side for T-plugs, complete with screws and plugs	2 pcs
P2229906U	Plastic drawer 22 L with lock	1 pc.
P2909912U	Divider for bag holder 150 L	1 pc.
P2909920U	Closing profile for central basket and central bag holder, with screws and plugs	1 pc.
P2909946A	Blue cover for bag holder 150 L with check list holder	1 pc.
P3059953E	Fixed side wall with fixing pins	3 pcs
P3059954E	Right door with fixing pins	1 pc.
P3199903U	Central ring for 4 l buckets complete with lockable grey lid and 2 pistons	1 pc.
P3909952E	Door with fixing pins for bag holder	1 pc.
P515010U	Supporting plate with 2 wheels ø 100 mm and 2 blocking pins	1 pc.
P8169905U	150-liter bag holder for Alpha standard and 90-liter for Alpha with Split system, male version, with hooks, pistons, screws and plugs	1 pc.
R1040010	Rilsan coated wringer support complete with screws	1 pc.

⚠ ACCESSORIES TO BE ORDERED SEPARATELY

0000AT0160A	Plastified bag 56x92 cm, capacity 80 L, blu	1 pc.
0000AT0160B	Plastified bag 56x92 cm, capacity 80 L, red	1 pc.
P2909915U	Pedal kit for Alpha trolleys with large, mini or supporting plate, 150 lt bag holder and ø 100 mm wheels	1 pc.

ON REQUEST, WITH SURCHARGE

	Rubber wheels ø 125 mm TROLLEY REF. MA3803400U002		Wheels ø 125 mm TROLLEY REF. MA3806400U002		Bag holder with adjustable push-grip TROLLEY REF. MA3801450U002
--	---	--	--	--	---



Multipurpose trolleys



ALPHA

MORGAN

CHROMED AND RILSAN COATED TROLLEYS

ALPHA 3801500 - plastic trolley with Split system

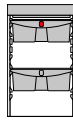
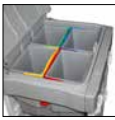

REF.	PCK	VOLUME (m³)	GROSS WEIGHT (kg)	SIZE (cm)
MA3801500U000	1	0,522	38	139x68x110

0000SE0204UA	Grey plastic bucket 4 L with blue upper plastic handle	1 pc.
0000SE0204UB	Grey plastic bucket 4 L with red upper plastic handle	1 pc.
0000SE0204UC	Grey plastic bucket 4 L with yellow upper plastic handle	1 pc.
0000SE0204UF	Grey plastic bucket 4 L with green upper plastic handle	1 pc.
0000SM00165	Set of T-shaped light grey closing plugs for vertical frames (6 pcs)	2 pcs
3048	Set of 3 stickers for buckets	1 pc.
7004A	REGULAR - blue plastic down-press wringer with plastic gears	1 pc.
8108A	Blue plastic bucket 15 L with plastic handle	1 pc.
8108B	Red plastic bucket 15 L with plastic handle	1 pc.
P066011U	Long base with wheels ø 100 mm	1 pc.
P1229906U	Grey plastic drawer 22 L without key	1 pc.
P1909937U	Plastic lift for buckets, with holes for bottles, fitting drawers 22 and 40 L	1 pc.
P2039903E	Vertical frame, 1 side with slides + 1 side for T-plugs, complete with screws and plugs	2 pcs
P2059963E	Door for Alpha bag holder with Split system	1 pc.
P2229906U	Plastic drawer 22 L with lock	1 pc.
P2229913U	33L plastic drawer with lock for Alpha with Split system	1 pc.
P2229914U	Removable plastic shelf for Alpha with Split system	1 pc.
P2909912U	Divider for bag holder 150 L	1 pc.
P2909920U	Closing profile for central basket and central bag holder, with screws and plugs	1 pc.
P2909946A	Blue cover for bag holder 150 L with check list holder	1 pc.
P2909966U	Bag holder insert with storage compartment and divider for Alpha with Split system	1 pc.
P3059953E	Fixed side wall with fixing pins	1 pc.
P3059954E	Right door with fixing pins	1 pc.
P3059967E	Set walls, right and left, for Alpha with Split system	1 pc.
P3199903U	Central ring for 4 l buckets complete with lockable grey lid and 2 pistons	1 pc.
P515010U	Supporting plate with 2 wheels ø 100 mm and 2 blocking pins	1 pc.
P8169905U	150-liter bag holder for Alpha standard and 90-liter for Alpha with Split system, male version, with hooks, pistons, screws and plugs	1 pc.
R1040010	Rilsan coated wringer support complete with screws	1 pc.

ACCESSORIES TO BE ORDERED SEPARATELY

0000AT0310A	Blue plastified bag 45 L, 32x23x63 cm	1 pc.
0000AT0310B	Red plastified bag 45 L, 32x23x63 cm	1 pc.
P2909915U	Pedal kit for Alpha trolleys with large, mini or supporting plate, 150 lt bag holder and ø 100 mm wheels	1 pc.

ON REQUEST, WITH SURCHARGE

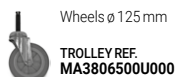

ALPHA 4801400 - plastic trolley

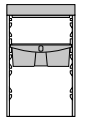

REF.	PCK	VOLUME (m³)	GROSS WEIGHT (kg)	SIZE (cm)
MA4801400U002	1	0,455	36,92	139x68x110

0000SE0108A	Blue plastic bucket 8 L with plastic handle	1 pc.
0000SE0108B	Red plastic bucket 8 L with plastic handle	1 pc.
0000SE0108C	Yellow plastic bucket 8 L with plastic handle	1 pc.
0000SM00165	Set of T-shaped light grey closing plugs for vertical frames (6 pcs)	2 pcs
7004A	REGULAR - blue plastic down-press wringer with plastic gears	1 pc.
8108A	Blue plastic bucket 15 L with plastic handle	1 pc.
8108B	Red plastic bucket 15 L with plastic handle	1 pc.
P066011U	Long base with wheels ø 100 mm	1 pc.
P1229906U	Grey plastic drawer 22 L without key	1 pc.
P2039903E	Vertical frame, 1 side with slides + 1 side for T-plugs, complete with screws and plugs	2 pcs
P2909912U	Divider for bag holder 150 L	1 pc.
P2909920U	Closing profile for central basket and central bag holder, with screws and plugs	1 pc.
P2909946A	Blue cover for bag holder 150 L with check list holder	1 pc.
P3059953E	Fixed side wall with fixing pins	3 pcs
P3059954E	Right door with fixing pins	1 pc.
P3199905U	Central plastic frame with grey cover with locking key and 2 shock absorbing pistons for versions with 3 hanging buckets 8 L	1 pc.
P3909952E	Door with fixing pins for bag holder	1 pc.
P515010U	Supporting plate with 2 wheels ø 100 mm and 2 blocking pins	1 pc.
P8169905U	150-liter bag holder for Alpha standard and 90-liter for Alpha with Split system, male version, with hooks, pistons, screws and plugs	1 pc.
R1040010	Rilsan coated wringer support complete with screws	1 pc.

ACCESSORIES TO BE ORDERED SEPARATELY

0000AT0160A	Plastified bag 56x92 cm, capacity 80 L, blu	1 pc.
0000AT0160B	Plastified bag 56x92 cm, capacity 80 L, red	1 pc.
P2909915U	Pedal kit for Alpha trolleys with large, mini or supporting plate, 150 lt bag holder and ø 100 mm wheels	1 pc.

ON REQUEST, WITH SURCHARGE



PRODUCT PARTIALLY MADE OF PLASTIC COMPONENTS CERTIFIED PSV - PLASTIC SECOND LIFE



ALPHA

MORGAN

CHROMED AND RILSAN COATED TROLLEYS

ALPHA 0801114 - plastic trolley with Split system



OneFred
NOT INCLUDED

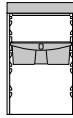

REF.	PCK	VOLUME (m³)	GROSS WEIGHT (kg)	SIZE (cm)
MA0801114U000	1	0,372	31,37	98x58x114

Complete trolley sizes with OneFred 161x65x114 cm

0000SE0104A	Blue plastic bucket 4 L with plastic handle	1 pc.
0000SE0104A	Red plastic bucket 4 L with plastic handle	1 pc.
0000SE0104C	Yellow plastic bucket 4 L with plastic handle	1 pc.
0000SE0104F	Green plastic bucket 4 L with plastic handle	1 pc.
0000SM00165	Set of T-shaped light grey closing plugs for vertical frames (6 pcs)	2 pcs
3048	Set of 3 stickers for buckets	1 pc.
P066011U	Long base with wheels ø 100 mm	1 pc.
P1229906U	Grey plastic drawer 22 L without key	1 pc.
P2039903E	Vertical frame, 1 side with slides + 1 side for T-plugs, complete with screws and plugs	2 pcs
P2059963E	Door for Alpha bag holder with Split system	1 pc.
P2199906U	Central plastic basket (female-female version) with plugs	1 pc.
P2229913U	33L plastic drawer with lock for Alpha with Split system	1 pc.
P2229914U	Removable plastic shelf for Alpha with Split system	1 pc.
P2909912U	Divider for bag holder 150 L	1 pc.
P2909920U	Closing profile for central basket and central bag holder, with screws and plugs	1 pc.
P2909946A	Blue cover for bag holder 150 L with check list holder	1 pc.
P2909966U	Bag holder insert with storage compartment and divider for Alpha with Split system	1 pc.
P3059953E	Fixed side wall with fixing pins	1 pc.
P3059954E	Right door with fixing pins	1 pc.
P3059967E	Set walls, right and left, for Alpha with Split system	1 pc.
P8169905U	150-liter bag holder for Alpha standard and 90-liter for Alpha with Split system, male version, with hooks, pistons, screws and plugs	1 pc.

ACCESSORIES TO BE ORDERED SEPARATELY

0000AT0310A	Blue plastified bag 45 L , 32x23x63 cm	1 pc.
0000AT0310B	Red plastified bag 45 L , 32x23x63 cm	1 pc.
0000LF0030YU	ONEFRED - 30 l plastic trolley with plastic handle	1 pc.
0000SM00298	PEG KIT - OneFred attachment kit for Alpha trolleys with broom holder	1 pc.
P2909915U	Pedal kit for Alpha trolleys with large, mini or supporting plate, 150 lt bag holder and ø 100 mm wheels	1 pc.

ON REQUEST, WITH SURCHARGE

	Rubber wheels ø 125 mm TROLLEY REF. MA0803114U000		Wheels ø 125 mm TROLLEY REF. MA0806114U000		Bag holder with adjustable push-grip TROLLEY REF. MA0801164U000
--	--	--	---	--	--





ALPHA

MORGAN

CHROMED AND RILSAN COATED TROLLEYS

Soaking

ALPHA 1670 - plastic trolley



ALPHA 1673 - plastic trolley



REF.	PCK	VOLUME (m³)	GROSS WEIGHT (kg)	SIZE (cm) ↓ ↓ ↓
0000MA1670U00	1	0,177	15,21	78x58x111

0000SE0104A	Blue plastic bucket 4 L with plastic handle	1 pc.
0000SE0104A	Red plastic bucket 4 L with plastic handle	1 pc.
0000SE1322A	TOP-DOWN® - blue plastic bucket 20 L with plastic handle and hermetic cover	1 pc.
0000SM00163	Set of T-shaped dark grey closing plugs for vertical frames (6 pcs)	1 pc.
P059061U	Short base with wheels ø 125 mm	1 pc.
P1191100U	Side plastic basket	1 pc.
P2031103U	Vertical frame with reinforcement, 1 smooth side + 1 side for T-plugs, complete with screws	1 pc.
P206030U	1x40 L + 1x80 L plastic divider for plastic bag holder 120 L	1 pc.
P8161112U	120l waste bag holder with tray, hooks, screws and plugs	1 pc.

⚠ ACCESSORIES TO BE ORDERED SEPARATELY

0000AT0160A	Plastified bag 56x92 cm, capacity 80 L, blu	1 pc.
0000AT0170B	Plastified bag 48x97 cm, capacity 60 L, red	1 pc.
P291918A	Blue cover for bag holder 120 L	1 pc.

ON REQUEST, WITH SURCHARGE



REF.	PCK	VOLUME (m³)	GROSS WEIGHT (kg)	SIZE (cm) ↓ ↓ ↓
0000MA1673U00	1	0,261	20,05	107x58x111

0000SE0104A	Blue plastic bucket 4 L with plastic handle	1 pc.
0000SE0104A	Red plastic bucket 4 L with plastic handle	1 pc.
0000SE1222B	Red plastic bucket 20 L with plastic handle	1 pc.
0000SE1322A	TOP-DOWN® - blue plastic bucket 20 L with plastic handle and hermetic cover	1 pc.
0000SE1322B	TOP-DOWN® - red plastic bucket 20 L with plastic handle and hermetic cover	1 pc.
0000SM00163	Set of T-shaped dark grey closing plugs for vertical frames (6 pcs)	1 pc.
P059061U	Short base with wheels ø 125 mm	1 pc.
P075060U	Supporting plastic plate with 1 wheel ø 125 mm	1 pc.
P1191100U	Side plastic basket	1 pc.
P2031103U	Vertical frame with reinforcement, 1 smooth side + 1 side for T-plugs, complete with screws	1 pc.
P206030U	1x40 L + 1x80 L plastic divider for plastic bag holder 120 L	1 pc.
P8161112U	120l waste bag holder with tray, hooks, screws and plugs	1 pc.

⚠ ACCESSORIES TO BE ORDERED SEPARATELY

0000AT0160A	Plastified bag 56x92 cm, capacity 80 L, blu	1 pc.
0000AT0170B	Plastified bag 48x97 cm, capacity 60 L, red	1 pc.
P291918A	Blue cover for bag holder 120 L	1 pc.

ON REQUEST, WITH SURCHARGE





ALPHA

MORGAN

CHROMED AND RILSAN COATED TROLLEYS

ALPHA 0406700 - plastic trolley



ALPHA 2672 - plastic trolley



REF.	PCK	VOLUME (m³)	GROSS WEIGHT (kg)	SIZE (cm) ↓ ↓ ↓
MA0406700U000	1	0,291	23,26	92x58x115

0000SE1322A	TOP-DOWN® - blue plastic bucket 20 L with plastic handle and hermetic cover	2 pcs
0000SE1322B	TOP-DOWN® - red plastic bucket 20 L with plastic handle and hermetic cover	3 pcs
0000SM00163	Set of T-shaped dark grey closing plugs for vertical frames (6 pcs)	1 pc.
0000SM00639	Uni-Move 2 handle holder kit	1 pc.
P066061U	Long base with wheels ø 125 mm	1 pc.
P1191100U	Side plastic basket	3 pcs
P1901112U	Plastic rising support for basket art. P1191100U	4 pcs
P2031102U	Vertical frame with reinforcement, 2 sides with T-plugs, complete with screws	1 pc.
P2191102U	Plastic basket complete with 3 dividers fitting vertical frame Alpha trolleys	1 pc.
P2909960U	Closing profile for vertical frame complete with screws and plugs	1 pc.

ON REQUEST, WITH SURCHARGE



REF.	PCK	VOLUME (m³)	GROSS WEIGHT (kg)	SIZE (cm) ↓ ↓ ↓
0000MA2672U00	1	0,372	25,57	118x58x114

0000SE0104A	Blue plastic bucket 4 L with plastic handle	1 pc.
0000SE0104A	Red plastic bucket 4 L with plastic handle	1 pc.
0000SE0104C	Yellow plastic bucket 4 L with plastic handle	1 pc.
0000SE0104F	Green plastic bucket 4 L with plastic handle	1 pc.
0000SE1222B	Red plastic bucket 20 L with plastic handle	1 pc.
0000SE1322A	TOP-DOWN® - blue plastic bucket 20 L with plastic handle and hermetic cover	1 pc.
0000SE1322B	TOP-DOWN® - red plastic bucket 20 L with plastic handle and hermetic cover	1 pc.
0000SM00165	Set of T-shaped light grey closing plugs for vertical frames (6 pcs)	2 pcs
3048	Set of 3 stickers for buckets	1 pc.
P059061U	Short base with wheels ø 125 mm	1 pc.
P1191100U	Side plastic basket	2 pcs
P1229906U	Grey plastic drawer 22 L without key	1 pc.
P165000U	Base extension for Alpha trolleys and for the bag supporting plastic plate of the Morgan Hotel Elegance trolleys	1 pc.
P2039903E	Vertical frame, 1 side with slides + 1 side for T-plugs, complete with screws and plugs	2 pcs
P206030U	1x40 L + 1x80 L plastic divider for plastic bag holder 120 L	1 pc.
P2199906U	Central plastic basket (female-female version) with plugs	1 pc.
P2909920U	Closing profile for central basket and central bag holder, with screws and plugs	1 pc.
P8161111U	120l waste bag holder, male fitting, with dustpan hook and handle clip	1 pc.

⚠ ACCESSORIES TO BE ORDERED SEPARATELY

0000AT0160A	Plastified bag 56x92 cm, capacity 80 L, blu	1 pc.
0000AT0170B	Plastified bag 48x97 cm, capacity 60 L, red	1 pc.
P291918A	Blue cover for bag holder 120 L	1 pc.

ON REQUEST, WITH SURCHARGE

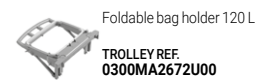
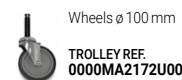

Multipurpose trolleys



ALPHA

MORGAN

CHROMED AND RILSAN COATED TROLLEYS

ALPHA 5671 - plastic trolley



ALPHA 0506702 - plastic trolley with Click Safe system

NEW



REF.	PCK	VOLUME (m³)	GROSS WEIGHT (kg)	SIZE (cm) ↓ ↓ ↓
0000MA5671U00	1	0,372	26,37	118x58x114

0000SE0104A	Blue plastic bucket 4 L with plastic handle	1 pc.
0000SE0104A	Red plastic bucket 4 L with plastic handle	1 pc.
0000SE0104C	Yellow plastic bucket 4 L with plastic handle	1 pc.
0000SE0104F	Green plastic bucket 4 L with plastic handle	1 pc.
0000SE1222B	Red plastic bucket 20 L with plastic handle	1 pc.
0000SE1322A	TOP-DOWN® - blue plastic bucket 20 L with plastic handle and hermetic cover	1 pc.
0000SE1322B	TOP-DOWN® - red plastic bucket 20 L with plastic handle and hermetic cover	1 pc.
0000SM00165	Set of T-shaped light grey closing plugs for vertical frames (6 pcs)	2 pcs
3048	Set of 3 stickers for buckets	1 pc.
P066061U	Long base with wheels ø 125 mm	1 pc.
P1191100U	Side plastic basket	1 pc.
P1229906U	Grey plastic drawer 22 L without key	1 pc.
P165000U	Base extension for Alpha trolleys and for the bag supporting plastic plate of the Morgan Hotel Elegance trolleys	1 pc.
P2039903E	Vertical frame, 1 side with slides + 1 side for T-plugs, complete with screws and plugs	2 pcs
P206030U	1x40 L + 1x80 L plastic divider for plastic bag holder 120 L	1 pc.
P2199906U	Central plastic basket (female-female version) with plugs	1 pc.
P2909920U	Closing profile for central basket and central bag holder, with screws and plugs	1 pc.
P8161111U	120l waste bag holder, male fitting, with dustpan hook and handle clip	1 pc.

⚠ ACCESSORIES TO BE ORDERED SEPARATELY

0000AT0160A	Plastified bag 56x92 cm, capacity 80 L, blu	1 pc.
0000AT0170B	Plastified bag 48x97 cm, capacity 60 L, red	1 pc.
P291918A	Blue cover for bag holder 120 L	1 pc.

ON REQUEST, WITH SURCHARGE



REF.	PCK	VOLUME (m³)	GROSS WEIGHT (kg)	SIZE (cm) ↓ ↓ ↓
MA0506702U027	1	0,372	26,47	118x58x114

Click Safe system requires the use of the corresponding Click Safe folding mop holder (See the catalog under the line Soaking and Floor Washing Systems - system with pockets)

0000SE0104A	Blue plastic bucket 4 L with plastic handle	1 pc.
0000SE0104A	Red plastic bucket 4 L with plastic handle	1 pc.
0000SE0104C	Yellow plastic bucket 4 L with plastic handle	1 pc.
0000SE0104F	Green plastic bucket 4 L with plastic handle	1 pc.
0000SE1222B	Red plastic bucket 20 L with plastic handle	2 pcs
0000SE1322A	TOP-DOWN® - blue plastic bucket 20 L with plastic handle and hermetic cover	1 pc.
0000SM00165	Set of T-shaped light grey closing plugs for vertical frames (6 pcs)	2 pcs
3048	Set of 3 stickers for buckets	1 pc.
P066061U	Long base with wheels ø 125 mm	1 pc.
P1191100U	Side plastic basket	1 pc.
P1229906U	Grey plastic drawer 22 L without key	1 pc.
P165000U	Base extension for Alpha trolleys and for the bag supporting plastic plate of the Morgan Hotel Elegance trolleys	1 pc.
P190360U	Plastic lid for Click Safe system	1 pc.
P2039903E	Vertical frame, 1 side with slides + 1 side for T-plugs, complete with screws and plugs	2 pcs
P206030U	1x40 L + 1x80 L plastic divider for plastic bag holder 120 L	1 pc.
P2199906U	Central plastic basket (female-female version) with plugs	1 pc.
P2909920U	Closing profile for central basket and central bag holder, with screws and plugs	1 pc.
P8161111U	120l waste bag holder, male fitting, with dustpan hook and handle clip	1 pc.

⚠ ACCESSORIES TO BE ORDERED SEPARATELY

0000AT0160A	Plastified bag 56x92 cm, capacity 80 L, blu	1 pc.
0000AT0170B	Plastified bag 48x97 cm, capacity 60 L, red	1 pc.
P291918A	Blue cover for bag holder 120 L	1 pc.

ON REQUEST, WITH SURCHARGE



MULTIPURPOSE
TROLLEYS



PRODUCT PARTIALLY MADE OF PLASTIC COMPONENTS CERTIFIED PSV - PLASTIC SECOND LIFE



ALPHA

MORGAN

CHROMED AND RILSAN COATED TROLLEYS

ALPHA 0506711 - plastic trolley



ALPHA 2606701 - plastic trolley



REF.	PCK	VOLUME (m³)	GROSS WEIGHT (kg)	SIZE (cm) ↓ ↓ ↓
MA0506711U000	1	0,47	34,71	123x65x118

0000SE0104A	Blue plastic bucket 4 L with plastic handle	1 pc.
0000SE0104A	Red plastic bucket 4 L with plastic handle	1 pc.
0000SE0104C	Yellow plastic bucket 4 L with plastic handle	1 pc.
0000SE0104F	Green plastic bucket 4 L with plastic handle	1 pc.
0000SE1222B	Red plastic bucket 20 L with plastic handle	1 pc.
0000SE1322A	TOP-DOWN® - blue plastic bucket 20 L with plastic handle and hermetic cover	1 pc.
0000SE1322B	TOP-DOWN® - red plastic bucket 20 L with plastic handle and hermetic cover	1 pc.
0000SM00165	Set of T-shaped light grey closing plugs for vertical frames (6 pcs)	2 pcs
3048	Set of 3 stickers for buckets	1 pc.
P065060U	Supporting plastic plate with two wheels ø 125 mm to fix to Alpha base	1 pc.
P066061U	Long base with wheels ø 125 mm	1 pc.
P1229906U	Grey plastic drawer 22 L without key	1 pc.
P2039903E	Vertical frame, 1 side with slides + 1 side for T-plugs, complete with screws and plugs	2 pcs
P206030U	1x40 L + 1x80 L plastic divider for plastic bag holder 120 L	1 pc.
P2199906U	Central plastic basket (female-female version) with plugs	1 pc.
P2909920U	Closing profile for central basket and central bag holder, with screws and plugs	1 pc.
P8161111U	120l waste bag holder, male fitting, with dustpan hook and handle clip	1 pc.
R2200040	Rilsan coated bucket holder for buckets 10 and 20 L fitting Morgan vertical frame and Alpha trolley	1 pc.
R3030162	Rilsan coated trolley kit with wheels ø 200 mm with trolley locking device and fixing hooks for Top-Down buckets 10 L and 20 L	1 pc.

⚠ ACCESSORIES TO BE ORDERED SEPARATELY

0000AT0160A	Plastified bag 56x92 cm, capacity 80 L, blu	1 pc.
0000AT0170B	Plastified bag 48x97 cm, capacity 60 L, red	1 pc.
P291918A	Blue cover for bag holder 120 L	1 pc.

ON REQUEST, WITH SURCHARGE

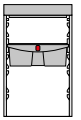

REF.	PCK	VOLUME (m³)	GROSS WEIGHT (kg)	SIZE (cm) ↓ ↓ ↓
MA2606701U000	1	0,372	27,7	118x58x110

0000SE0108A	Blue plastic bucket 8 L with plastic handle	1 pc.
0000SE0108B	Red plastic bucket 8 L with plastic handle	1 pc.
0000SE0108C	Yellow plastic bucket 8 L with plastic handle	1 pc.
0000SE1322A	TOP-DOWN® - blue plastic bucket 20 L with plastic handle and hermetic cover	1 pc.
0000SE1322B	TOP-DOWN® - red plastic bucket 20 L with plastic handle and hermetic cover	1 pc.
0000SM00165	Set of T-shaped light grey closing plugs for vertical frames (6 pcs)	2 pcs
P066061U	Long base with wheels ø 125 mm	1 pc.
P1191100U	Side plastic basket	1 pc.
P165000U	Base extension for Alpha trolleys and for the bag supporting plastic plate of the Morgan Hotel Elegance trolleys	1 pc.
P2039903E	Vertical frame, 1 side with slides + 1 side for T-plugs, complete with screws and plugs	2 pcs
P206030U	1x40 L + 1x80 L plastic divider for plastic bag holder 120 L	1 pc.
P2229906U	Plastic drawer 22 L with lock	1 pc.
P2909920U	Closing profile for central basket and central bag holder, with screws and plugs	1 pc.
P3059953E	Fixed side wall with fixing pins	1 pc.
P3059954E	Right door with fixing pins	1 pc.
P3199905U	Central plastic frame with grey cover with locking key and 2 shock absorbing pistons for versions with 3 hanging buckets 8 L	1 pc.
P8161111U	120l waste bag holder, male fitting, with dustpan hook and handle clip	1 pc.

⚠ ACCESSORIES TO BE ORDERED SEPARATELY

0000AT0160A	Plastified bag 56x92 cm, capacity 80 L, blu	1 pc.
0000AT0170B	Plastified bag 48x97 cm, capacity 60 L, red	1 pc.
P291918A	Blue cover for bag holder 120 L	1 pc.

ON REQUEST, WITH SURCHARGE



Multipurpose trolleys



ALPHA

MORGAN

CHROMED AND RILSAN COATED TROLLEYS

ALPHA 3306700 - plastic trolley

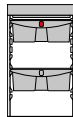
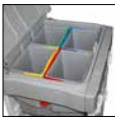

REF.	PCK	VOLUME (m³)	GROSS WEIGHT (kg)	SIZE (cm)
MA3306700U000	1	0,372	29,47	118x58x110

Trolley dimensions with closed foldable bag holder 85x58x149 cm

0000SE0204UA	Grey plastic bucket 4 L with blue upper plastic handle	1 pc.
0000SE0204UB	Grey plastic bucket 4 L with red upper plastic handle	1 pc.
0000SE0204UC	Grey plastic bucket 4 L with yellow upper plastic handle	1 pc.
0000SE0204UF	Grey plastic bucket 4 L with green upper plastic handle	1 pc.
0000SE1322A	TOP-DOWN® - blue plastic bucket 20 L with plastic handle and hermetic cover	1 pc.
0000SE1322B	TOP-DOWN® - red plastic bucket 20 L with plastic handle and hermetic cover	1 pc.
0000SM00165	Set of T-shaped light grey closing plugs for vertical frames (6 pcs)	2 pcs
3048	Set of 3 stickers for buckets	1 pc.
P059061U	Short base with wheels ø 125 mm	1 pc.
P1191100U	Side plastic basket	2 pcs
P1229906U	Grey plastic drawer 22 L without key	1 pc.
P175000U	Supporting plastic plate for Alpha trolleys	1 pc.
P1909937U	Plastic lift for buckets, with holes for bottles, fitting drawers 22 and 40 L	1 pc.
P2039903E	Vertical frame, 1 side with slides + 1 side for T-plugs, complete with screws and plugs	2 pcs
P206030U	1x40 L + 1x80 L plastic divider for plastic bag holder 120 L	1 pc.
P2229906U	Plastic drawer 22 L with lock	1 pc.
P2909920U	Closing profile for central basket and central bag holder, with screws and plugs	1 pc.
P3059953E	Fixed side wall with fixing pins	1 pc.
P3059954E	Right door with fixing pins	1 pc.
P3199903U	Central ring for 4 l buckets complete with lockable grey lid and 2 pistons	1 pc.
P8161115U	Folding 120l waste bag holder with deep fitting, with bag retaining hooks, dustpan hook, handle clip, screws and plugs	1 pc.

⚠ ACCESSORIES TO BE ORDERED SEPARATELY

0000AT0160A	Plastified bag 56x92 cm, capacity 80 L, blu	1 pc.
0000AT0170B	Plastified bag 48x97 cm, capacity 60 L, red	1 pc.
P291918A	Blue cover for bag holder 120 L	1 pc.

ON REQUEST, WITH SURCHARGE

	Rubber wheels ø 125 mm TROLLEY REF. MA3303700U000		Wheels ø 100 mm TROLLEY REF. MA3301700U000
---	--	---	---

ALPHA 0306702 - plastic trolley

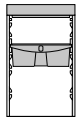

REF.	PCK	VOLUME (m³)	GROSS WEIGHT (kg)	SIZE (cm)
MA0306702UD00	1	0,31	23,49	121x58x114

Trolley dimensions with closed foldable bag holder 88x58x149 cm

0000SE0104A	Blue plastic bucket 4 L with plastic handle	1 pc.
0000SE0104A	Red plastic bucket 4 L with plastic handle	1 pc.
0000SE0104C	Yellow plastic bucket 4 L with plastic handle	1 pc.
0000SE0104F	Green plastic bucket 4 L with plastic handle	1 pc.
0000SE1322A	TOP-DOWN® - blue plastic bucket 20 L with plastic handle and hermetic cover	1 pc.
0000SM00165	Set of T-shaped light grey closing plugs for vertical frames (6 pcs)	2 pcs
3048	Set of 3 stickers for buckets	1 pc.
P1229906U	Grey plastic drawer 22 L without key	1 pc.
P159061U	Short base with 5 wheels ø 125 mm	1 pc.
P165001U	Extension for Alpha trolleys	1 pc.
P175000U	Supporting plastic plate for Alpha trolleys	1 pc.
P2039908E	Vertical frame 1 side with slides + 1 side T-plugs with reinforcements, screws and plugs	2 pcs
P206030U	1x40 L + 1x80 L plastic divider for plastic bag holder 120 L	1 pc.
P2199906U	Central plastic basket (female-female version) with plugs	1 pc.
P2909920U	Closing profile for central basket and central bag holder, with screws and plugs	1 pc.
P3059953E	Fixed side wall with fixing pins	1 pc.
P3059954E	Right door with fixing pins	1 pc.
P8161113U	Folding 120l waste bag holder, with bag retaining hooks, dustpan hook, handle clip, screws and plugs	1 pc.

⚠ ACCESSORIES TO BE ORDERED SEPARATELY

0000AT0160A	Plastified bag 56x92 cm, capacity 80 L, blu	1 pc.
0000AT0170B	Plastified bag 48x97 cm, capacity 60 L, red	1 pc.
P291918A	Blue cover for bag holder 120 L	1 pc.
P320100UA	EQUODOSE - dosing device with one tank 6L for mop soaking on demand, with EPDM washers	1 pc.

ON REQUEST, WITH SURCHARGE

	Rubber wheels ø 125 mm TROLLEY REF. MA0303702UD00		Wheels ø 100 mm TROLLEY REF. MA0301702UD00
---	--	---	---





ALPHA

MORGAN

CHROMED AND RILSAN COATED TROLLEYS

ALPHA MR3606701 - plastic trolley with Link-Up system

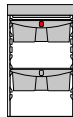
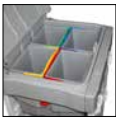

REF.	PCK	VOLUME (m³)	GROSS WEIGHT (kg)	SIZE (cm)
MR3606701U000	1	0,549	44,97	146x58x112

0000SE0204UA	Grey plastic bucket 4 L with blue upper plastic handle	1 pc.
0000SE0204UB	Grey plastic bucket 4 L with red upper plastic handle	1 pc.
0000SE0204UC	Grey plastic bucket 4 L with yellow upper plastic handle	1 pc.
0000SE0204UF	Grey plastic bucket 4 L with green upper plastic handle	1 pc.
0000SE1322A	TOP-DOWN® - blue plastic bucket 20 L with plastic handle and hermetic cover	1 pc.
0000SE1322B	TOP-DOWN® - red plastic bucket 20 L with plastic handle and hermetic cover	1 pc.
0000SM00165	Set of T-shaped light grey closing plugs for vertical frames (6 pcs)	2 pcs
0000SM00617	Quick connection kit Link-Up (4 pcs)	1 pc.
3048	Set of 3 stickers for buckets	1 pc.
P025061U	Compact base with wheels ø 125 mm	1 pc.
P059061U	Short base with wheels ø 125 mm	1 pc.
P1191100U	Side plastic basket	1 pc.
P1229906U	Grey plastic drawer 22 L without key	1 pc.
P165001U	Extension for Alpha trolleys	1 pc.
P1909937U	Plastic lift for buckets, with holes for bottles, fitting drawers 22 and 40 L	1 pc.
P1909967U	Closing profile for bag holder 120 L	1 pc.
P2031103U	Vertical frame with reinforcement, 1 smooth side + 1 side for T-plugs, complete with screws	1 pc.
P2039903E	Vertical frame, 1 side with slides + 1 side for T-plugs, complete with screws and plugs	2 pcs
P206030U	1x40 L + 1x80 L plastic divider for plastic bag holder 120 L	1 pc.
P2229906U	Plastic drawer 22 L with lock	1 pc.
P2909920U	Closing profile for central basket and central bag holder, with screws and plugs	1 pc.
P2909921U	Closing profile with push-grip for central basket and central bag holder complete with screws and plugs	1 pc.
P3059953E	Fixed side wall with fixing pins	1 pc.
P3059954E	Right door with fixing pins	1 pc.
P3199903U	Central ring for 4 l buckets complete with lockable grey lid and 2 pistons	1 pc.
P8161111U	120l waste bag holder, male fitting, with dustpan hook and handle clip	1 pc.

ACCESSORIES TO BE ORDERED SEPARATELY

0000AT0160A	Plastified bag 56x92 cm, capacity 80 L, blu	1 pc.
0000AT0170B	Plastified bag 48x97 cm, capacity 60 L, red	1 pc.
P291918A	Blue cover for bag holder 120 L	1 pc.

ON REQUEST, WITH SURCHARGE

	Rubber wheels ø 125 mm TROLLEY REF. MR3603701U000		Wheels ø 100 mm TROLLEY REF. MR3601701U000
--	--	--	---

ALPHA 6670 - plastic trolley

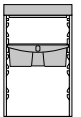

REF.	PCK	VOLUME (m³)	GROSS WEIGHT (kg)	SIZE (cm)
0000MA6670U00	1	0,372	26,37	118x58x114

0000SE0104A	Blue plastic bucket 4 L with plastic handle	1 pc.
0000SE0104A	Red plastic bucket 4 L with plastic handle	1 pc.
0000SE0104C	Yellow plastic bucket 4 L with plastic handle	1 pc.
0000SE0104F	Green plastic bucket 4 L with plastic handle	1 pc.
0000SE1322A	TOP-DOWN® - blue plastic bucket 20 L with plastic handle and hermetic cover	1 pc.
0000SE1322B	TOP-DOWN® - red plastic bucket 20 L with plastic handle and hermetic cover	1 pc.
0000SM00165	Set of T-shaped light grey closing plugs for vertical frames (6 pcs)	2 pcs
3048	Set of 3 stickers for buckets	1 pc.
P066061U	Long base with wheels ø 125 mm	1 pc.
P1191100U	Side plastic basket	2 pcs
P1229906U	Grey plastic drawer 22 L without key	1 pc.
P2039903E	Vertical frame, 1 side with slides + 1 side for T-plugs, complete with screws and plugs	2 pcs
P206030U	1x40 L + 1x80 L plastic divider for plastic bag holder 120 L	1 pc.
P2199906U	Central plastic basket (female-female version) with plugs	1 pc.
P2909920U	Closing profile for central basket and central bag holder, with screws and plugs	1 pc.
P3059953E	Fixed side wall with fixing pins	1 pc.
P3059954E	Right door with fixing pins	1 pc.
P8161111U	120l waste bag holder, male fitting, with dustpan hook and handle clip	1 pc.

ACCESSORIES TO BE ORDERED SEPARATELY

0000AT0160A	Plastified bag 56x92 cm, capacity 80 L, blu	1 pc.
0000AT0170B	Plastified bag 48x97 cm, capacity 60 L, red	1 pc.
P291918A	Blue cover for bag holder 120 L	1 pc.

ON REQUEST, WITH SURCHARGE

	Rubber wheels ø 125 mm TROLLEY REF. 0000MA6370U00		Wheels ø 100 mm TROLLEY REF. 0000MA6170U00
--	--	--	---





ALPHA

MORGAN

CHROMED AND RILSAN COATED TROLLEYS

ALPHA 3606718 - plastic trolley

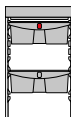

REF.	PCK	VOLUME (m³)	GROSS WEIGHT (kg)	SIZE (cm)
MA3606718U000	1	0,471	39,31	123x65x118

0000SE0204UA	Grey plastic bucket 4 L with blue upper plastic handle	1 pc.
0000SE0204UB	Grey plastic bucket 4 L with red upper plastic handle	1 pc.
0000SE0204UC	Grey plastic bucket 4 L with yellow upper plastic handle	1 pc.
0000SE0204UF	Grey plastic bucket 4 L with green upper plastic handle	1 pc.
0000SE1322A	TOP-DOWN® - blue plastic bucket 20 L with plastic handle and hermetic cover	1 pc.
0000SE1322B	TOP-DOWN® - red plastic bucket 20 L with plastic handle and hermetic cover	1 pc.
0000SM00165	Set of T-shaped light grey closing plugs for vertical frames (6 pcs)	2 pcs
3048	Set of 3 stickers for buckets	1 pc.
P065060U	Supporting plastic plate with two wheels ø 125 mm to fix to Alpha base	1 pc.
P066061U	Long base with wheels ø 125 mm	1 pc.
P1229906U	Grey plastic drawer 22 L without key	1 pc.
P1909937U	Plastic lift for buckets, with holes for bottles, fitting drawers 22 and 40 L	1 pc.
P2039903E	Vertical frame, 1 side with slides + 1 side for T-plugs, complete with screws and plugs	2 pcs
P206030U	1x40 L + 1x80 L plastic divider for plastic bag holder 120 L	1 pc.
P2229906U	Plastic drawer 22 L with lock	1 pc.
P2909920U	Closing profile for central basket and central bag holder, with screws and plugs	1 pc.
P3059953E	Fixed side wall with fixing pins	1 pc.
P3059954E	Right door with fixing pins	1 pc.
P3199903U	Central ring for 4 l buckets complete with lockable grey lid and 2 pistons	1 pc.
P8161111U	120l waste bag holder, male fitting, with dustpan hook and handle clip	1 pc.
R2200040	Rilsan coated bucket holder for buckets 10 and 20 L fitting Morgan vertical frame and Alpha trolley	1 pc.
R3030162	Rilsan coated trolley kit with wheels ø 200 mm with trolley locking device and fixing hooks for Top-Down buckets 10 L and 20 L	1 pc.

⚠️ ACCESSORIES TO BE ORDERED SEPARATELY

0000AT0160A	Plastified bag 56x92 cm, capacity 80 L, blu	1 pc.
0000AT0170B	Plastified bag 48x97 cm, capacity 60 L, red	1 pc.
P291918A	Blue cover for bag holder 120 L	1 pc.

ON REQUEST, WITH SURCHARGE



ALPHA 0706800 - plastic trolley with Split system



REF.	PCK	VOLUME (m³)	GROSS WEIGHT (kg)	SIZE (cm)
MA0706800U000	1	0,31	22,92	84x58x111

0000SE0104A	Blue plastic bucket 4 L with plastic handle	1 pc.
0000SE0104A	Red plastic bucket 4 L with plastic handle	1 pc.
0000SE1322A	TOP-DOWN® - blue plastic bucket 20 L with plastic handle and hermetic cover	1 pc.
0000SM00165	Set of T-shaped light grey closing plugs for vertical frames (6 pcs)	1 pc.
P059061U	Short base with wheels ø 125 mm	1 pc.
P1199900U	Upper basket	1 pc.
P165001U	Extension for Alpha trolleys	1 pc.
P2039906E	Vertical Frame, 1 smooth side + 1 side for T-plugs, complete with screws and plugs	1 pc.
P2059963E	Door for Alpha bag holder with Split system	1 pc.
P2229913U	33L plastic drawer with lock for Alpha with Split system	1 pc.
P2229914U	Removable plastic shelf for Alpha with Split system	1 pc.
P2909912U	Divider for bag holder 150 L	1 pc.
P2909946A	Blue cover for bag holder 150 L with check list holder	1 pc.
P3059967E	Set walls, right and left, for Alpha with Split system	1 pc.
P8169905U	150-liter bag holder for Alpha standard and 90-liter for Alpha with Split system, male version, with hooks, pistons, screws and plugs	1 pc.

⚠️ ACCESSORIES TO BE ORDERED SEPARATELY

0000AT0310A	Blue plastified bag 45 L, 32x23x63 cm	1 pc.
0000AT0310B	Red plastified bag 45 L, 32x23x63 cm	1 pc.
P3909962U	Pedal set for trolleys with short base, bag holder 150 L and wheels ø 125 mm	1 pc.

ON REQUEST, WITH SURCHARGE





ALPHA

MORGAN

CHROMED AND RILSAN COATED TROLLEYS

ALPHA 0706804 - plastic trolley with Split system



REF.	PCK	VOLUME (m³)	GROSS WEIGHT (kg)	SIZE (cm)
MA0706804U000	1	0,372	22,47	94x58x120

0000SE0204UA	Grey plastic bucket 4 L with blue upper plastic handle	1 pc.
0000SE0204UB	Grey plastic bucket 4 L with red upper plastic handle	1 pc.
0000SE1322A	TOP-DOWN® - blue plastic bucket 20 L with plastic handle and hermetic cover	1 pc.
0000SE1322B	TOP-DOWN® - red plastic bucket 20 L with plastic handle and hermetic cover	1 pc.
0000SM00165	Set of T-shaped light grey closing plugs for vertical frames (6 pcs)	1 pc.
I1050072	Stainless steel holder for 4 lt buckets to be applied to 150 lt bag holder	1 pc.
P059061U	Short base with wheels ø 125 mm	1 pc.
P1191100U	Side plastic basket	1 pc.
P165001U	Extension for Alpha trolleys	1 pc.
P1909968U	Covering for bag holder 150L, foldable bag holder 120L and closing profiles	1 pc.
P2039906E	Vertical Frame, 1 smooth side + 1 side for T-plugs, complete with screws and plugs	1 pc.
P2059963E	Door for Alpha bag holder with Split system	1 pc.
P2229913U	33L plastic drawer with lock for Alpha with Split system	1 pc.
P2229914U	Removable plastic shelf for Alpha with Split system	1 pc.
P2909912U	Divider for bag holder 150 L	1 pc.
P2909912U	Blue cover for bag holder 150 L with check list holder	1 pc.
P3059967E	Set walls, right and left, for Alpha with Split system	1 pc.
P8169905U	150-liter bag holder for Alpha standard and 90-liter for Alpha with Split system, male version, with hooks, pistons, screws and plugs	1 pc.

⚠ ACCESSORIES TO BE ORDERED SEPARATELY

0000AT0310A	Blue plastified bag 45 L , 32x23x63 cm	1 pc.
P3909962U	Pedal set for trolleys with short base, bag holder 150 L and wheels ø 125 mm	1 pc.

ON REQUEST, WITH SURCHARGE

Rubber wheels ø 125 mm TROLLEY REF. MA0703804U000	Wheels ø 100 mm TROLLEY REF. MA0701804U000	Bag holder with adjustable push-grip TROLLEY REF. MA0706854U000
--	---	--

ALPHA 0706806 - plastic trolley with Split system



Equodose® NOT INCLUDED



REF.	PCK	VOLUME (m³)	GROSS WEIGHT (kg)	SIZE (cm)
MA0706806UD00	1	0,372	28,77	118x58x120

0000SE0204UA	Grey plastic bucket 4 L with blue upper plastic handle	1 pc.
0000SE0204UB	Grey plastic bucket 4 L with red upper plastic handle	1 pc.
0000SE1322A	TOP-DOWN® - blue plastic bucket 20 L with plastic handle and hermetic cover	1 pc.
0000SE1322B	TOP-DOWN® - red plastic bucket 20 L with plastic handle and hermetic cover	1 pc.
0000SM00165	Set of T-shaped light grey closing plugs for vertical frames (6 pcs)	1 pc.
I1050072	Stainless steel holder for 4 lt buckets to be applied to 150 lt bag holder	1 pc.
P066061U	Long base with wheels ø 125 mm	1 pc.
P165001U	Extension for Alpha trolleys	1 pc.
P1909968U	Covering for bag holder 150L, foldable bag holder 120L and closing profiles	1 pc.
P2039909E	Vertical frame 1 smooth side + 1 side with T-plugs with reinforcement, screws and plugs	1 pc.
P2059963E	Door for Alpha bag holder with Split system	1 pc.
P2229913U	33L plastic drawer with lock for Alpha with Split system	1 pc.
P2229914U	Removable plastic shelf for Alpha with Split system	1 pc.
P2909912U	Divider for bag holder 150 L	1 pc.
P2909946A	Blue cover for bag holder 150 L with check list holder	1 pc.
P3059967E	Set walls, right and left, for Alpha with Split system	1 pc.
P8169905U	150-liter bag holder for Alpha standard and 90-liter for Alpha with Split system, male version, with hooks, pistons, screws and plugs	1 pc.

⚠ ACCESSORIES TO BE ORDERED SEPARATELY

0000AT0310A	Blue plastified bag 45 L , 32x23x63 cm	1 pc.
P2909962U	Pedal kit for Alpha trolleys with large, mini or supporting plate, 150 lt bag holder and ø 125 mm wheels	1 pc.
P320200UA	EQUODOSE - double dosing device for mop soaking on demand, with 2 tanks 6L end EPDM washer	1 pc.

ON REQUEST, WITH SURCHARGE

Rubber wheels ø 125 mm TROLLEY REF. MA0703806UD00	Wheels ø 100 mm TROLLEY REF. MA0701806UD00	Bag holder with adjustable push-grip TROLLEY REF. MA0706856UD00
--	---	--



MULTIPURPOSE TROLLEYS

Multipurpose trolleys



ALPHA

MORGAN

CHROMED AND RILSAN COATED TROLLEYS

ALPHA 0706855 - plastic trolley with Split system



Equodose®
NOT INCLUDED



REF.	PCK	VOLUME (m³)	GROSS WEIGHT (kg)	SIZE (cm)
MA0706855UD00	1	0,372	24,45	94x58x120

0000SE0204UA	Grey plastic bucket 4 L with blue upper plastic handle	1 pc.
0000SE0204UB	Grey plastic bucket 4 L with red upper plastic handle	1 pc.
0000SE1322A	TOP-DOWN® - blue plastic bucket 20 L with plastic handle and hermetic cover	1 pc.
0000SM00165	Set of T-shaped light grey closing plugs for vertical frames (6 pcs)	1 pc.
I1050072	Stainless steel holder for 4 lt buckets to be applied to 150 lt bag holder	1 pc.
P159061U	Short base with 5 wheels ø 125 mm	1 pc.
P165001U	Extension for Alpha trolleys	1 pc.
P1909968U	Covering for bag holder 150L, foldable bag holder 120L and closing profiles	1 pc.
P2039909E	Vertical frame 1 smooth side + 1 side with T-plugs with reinforcement, screws and plugs	1 pc.
P2059963E	Door for Alpha bag holder with Split system	1 pc.
P2229913U	33L plastic drawer with lock for Alpha with Split system	1 pc.
P2229914U	Removable plastic shelf for Alpha with Split system	1 pc.
P2909912U	Divider for bag holder 150 L	1 pc.
P2909946A	Blue cover for bag holder 150 L with check list holder	1 pc.
P3059967E	Set walls, right and left, for Alpha with Split system	1 pc.
P8269907U	150l waste bag holder for Alpha standard and 90l for Alpha with Split system, with adjustable push handle, male fitting, with hooks, pistons, screws and plugs	1 pc.

ACCESSORIES TO BE ORDERED SEPARATELY

0000AT0310A	Blue plastified bag 45 L, 32x23x63 cm	1 pc.
P320100UA	EQUODOSE - dosing device with one tank 6L for mop soaking on demand, with EPDM washers	1 pc.

ON REQUEST, WITH SURCHARGE



Rubber wheels
ø 125 mm
TROLLEY REF.
MA0703855UD00



Wheels ø 100 mm
TROLLEY REF.
MA0701855UD00

ALPHA 3806701 - plastic trolley

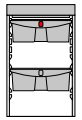

REF.	PCK	VOLUME (m³)	GROSS WEIGHT (kg)	SIZE (cm)
MA3806701U002	1	0,488	30,74	120x58x110

0000SE0204UA	Grey plastic bucket 4 L with blue upper plastic handle	1 pc.
0000SE0204UB	Grey plastic bucket 4 L with red upper plastic handle	1 pc.
0000SE0204UC	Grey plastic bucket 4 L with yellow upper plastic handle	1 pc.
0000SE0204UF	Grey plastic bucket 4 L with green upper plastic handle	1 pc.
0000SE1322A	TOP-DOWN® - blue plastic bucket 20 L with plastic handle and hermetic cover	1 pc.
0000SM00165	Set of T-shaped light grey closing plugs for vertical frames (6 pcs)	2 pcs
3048	Set of 3 stickers for buckets	1 pc.
P066061U	Long base with wheels ø 125 mm	1 pc.
P1229906U	Grey plastic drawer 22 L without key	1 pc.
P165000U	Base extension for Alpha trolleys and for the bag supporting plastic plate of the Morgan Hotel Elegance trolleys	1 pc.
P1909937U	Plastic lift for buckets, with holes for bottles, fitting drawers 22 and 40 L	1 pc.
P2039903E	Vertical frame, 1 side with slides + 1 side for T-plugs, complete with screws and plugs	2 pcs
P2229906U	Plastic drawer 22 L with lock	1 pc.
P2909912U	Divider for bag holder 150 L	1 pc.
P2909920U	Closing profile for central basket and central bag holder, with screws and plugs	1 pc.
P2909946A	Blue cover for bag holder 150 L with check list holder	1 pc.
P3059953E	Fixed side wall with fixing pins	3 pcs
P3059954E	Right door with fixing pins	1 pc.
P3199903U	Central ring for 4 l buckets complete with lockable grey lid and 2 pistons	1 pc.
P3909952E	Door with fixing pins for bag holder	1 pc.
P8169905U	150-liter bag holder for Alpha standard and 90-liter for Alpha with Split system, male version, with hooks, pistons, screws and plugs	1 pc.

ACCESSORIES TO BE ORDERED SEPARATELY

0000AT0160A	Plastified bag 56x92 cm, capacity 80 L, blu	1 pc.
0000AT0160B	Plastified bag 56x92 cm, capacity 80 L, red	1 pc.
P2909962U	Pedal kit for Alpha trolleys with large, mini or supporting plate, 150 lt bag holder and ø 125 mm wheels	1 pc.

ON REQUEST, WITH SURCHARGE



Rubber wheels
ø 125 mm
TROLLEY REF.
MA3803701U002



Wheels ø 100 mm
TROLLEY REF.
MA3801701U002



Bag holder with adjustable push-grip
TROLLEY REF.
MA3806751U002





ALPHA

MORGAN

CHROMED AND RILSAN COATED TROLLEYS

ALPHA 8670 - plastic trolley

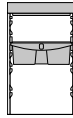

ALPHA 0806803 - plastic trolley with Split system

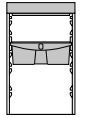

REF.	PCK	VOLUME (m³)	GROSS WEIGHT (kg)	SIZE (cm)
3000MA8670U00	1	0,485	30,89	127x58x114

0000SE0104A	Blue plastic bucket 4 L with plastic handle	1 pc.
0000SE0104A	Red plastic bucket 4 L with plastic handle	1 pc.
0000SE0104C	Yellow plastic bucket 4 L with plastic handle	1 pc.
0000SE0104F	Green plastic bucket 4 L with plastic handle	1 pc.
0000SE1322A	TOP-DOWN® - blue plastic bucket 20 L with plastic handle and hermetic cover	1 pc.
0000SE1322B	TOP-DOWN® - red plastic bucket 20 L with plastic handle and hermetic cover	1 pc.
0000SM00165	Set of T-shaped light grey closing plugs for vertical frames (6 pcs)	2 pcs
3048	Set of 3 stickers for buckets	1 pc.
P066061U	Long base with wheels ø 125 mm	1 pc.
P1191100U	Side plastic basket	2 pcs
P1229906U	Grey plastic drawer 22 L without key	1 pc.
P2039903E	Vertical frame, 1 side with slides + 1 side for T-plugs, complete with screws and plugs	2 pcs
P2199906U	Central plastic basket (female-female version) with plugs	1 pc.
P2909912U	Divider for bag holder 150 L	1 pc.
P2909920U	Closing profile for central basket and central bag holder, with screws and plugs	1 pc.
P2909946A	Blue cover for bag holder 150 L with check list holder	1 pc.
P3059953E	Fixed side wall with fixing pins	3 pcs
P3059954E	Right door with fixing pins	1 pc.
P3909952E	Door with fixing pins for bag holder	1 pc.
P8169905U	150-liter bag holder for Alpha standard and 90-liter for Alpha with Split system, male version, with hooks, pistons, screws and plugs	1 pc.

REF.	PCK	VOLUME (m³)	GROSS WEIGHT (kg)	SIZE (cm)
MA0806803U000	1	0,488	39,64	120x58x114

0000SE0104A	Blue plastic bucket 4 L with plastic handle	1 pc.
0000SE0104A	Red plastic bucket 4 L with plastic handle	1 pc.
0000SE0104C	Yellow plastic bucket 4 L with plastic handle	1 pc.
0000SE0104F	Green plastic bucket 4 L with plastic handle	1 pc.
0000SE1322A	TOP-DOWN® - blue plastic bucket 20 L with plastic handle and hermetic cover	1 pc.
0000SE1322B	TOP-DOWN® - red plastic bucket 20 L with plastic handle and hermetic cover	1 pc.
0000SM00165	Set of T-shaped light grey closing plugs for vertical frames (6 pcs)	2 pcs
3048	Set of 3 stickers for buckets	1 pc.
P066061U	Long base with wheels ø 125 mm	1 pc.
P1191100U	Side plastic basket	2 pcs
P1229906U	Grey plastic drawer 22 L without key	1 pc.
P2039903E	Vertical frame, 1 side with slides + 1 side for T-plugs, complete with screws and plugs	2 pcs
P2059963E	Door for Alpha bag holder with Split system	1 pc.
P2199906U	Central plastic basket (female-female version) with plugs	1 pc.
P2229913U	33L plastic drawer with lock for Alpha with Split system	1 pc.
P2229914U	Removable plastic shelf for Alpha with Split system	1 pc.
P2909912U	Divider for bag holder 150 L	1 pc.
P2909920U	Closing profile for central basket and central bag holder, with screws and plugs	1 pc.
P2909946A	Blue cover for bag holder 150 L with check list holder	1 pc.
P2909966U	Bag holder insert with storage compartment and divider for Alpha with Split system	1 pc.
P3059953E	Fixed side wall with fixing pins	1 pc.
P3059954E	Right door with fixing pins	1 pc.
P3059967E	Set walls, right and left, for Alpha with Split system	1 pc.
P8169905U	150-liter bag holder for Alpha standard and 90-liter for Alpha with Split system, male version, with hooks, pistons, screws and plugs	1 pc.

⚠ ACCESSORIES TO BE ORDERED SEPARATELY

0000AT0160A	Plastified bag 56x92 cm, capacity 80 L, blu	1 pc.
0000AT0160B	Plastified bag 56x92 cm, capacity 80 L, red	1 pc.
P2909962U	Pedal kit for Alpha trolleys with large, mini or supporting plate, 150 lt bag holder and ø 125 mm wheels	1 pc.

ON REQUEST, WITH SURCHARGE

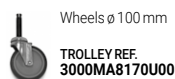

⚠ ACCESSORIES TO BE ORDERED SEPARATELY

0000AT0310A	Blue plastified bag 45 L, 32x23x63 cm	1 pc.
0000AT0310B	Red plastified bag 45 L, 32x23x63 cm	1 pc.
P2909962U	Pedal kit for Alpha trolleys with large, mini or supporting plate, 150 lt bag holder and ø 125 mm wheels	1 pc.

ON REQUEST, WITH SURCHARGE



Multipurpose trolleys



ALPHA

MORGAN

CHROMED AND RILSAN COATED TROLLEYS

ALPHA 3806780 - plastic trolley with Click Safe system

NEW



Door for bag holder
NOT INCLUDED



ALPHA MR0806703 - plastic trolley with Link-Up system

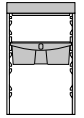
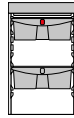
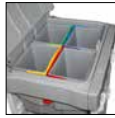

REF.	PCK	VOLUME (m³)	GROSS WEIGHT (kg)	SIZE (cm)
MA3806780U000	1	0,485	34,79	137x58x110

REF.	PCK	GROSS WEIGHT (kg)	SIZE (cm)
MR0806703U000	1	45,5	146x58x117

Click Safe system requires the use of the corresponding Click Safe folding mop holder (See the catalog under the line Soaking and Floor Washing Systems - system with pockets)

0000SE0204UA	Grey plastic bucket 4 L with blue upper plastic handle	1 pc.
0000SE0204UB	Grey plastic bucket 4 L with red upper plastic handle	1 pc.
0000SE0204UC	Grey plastic bucket 4 L with yellow upper plastic handle	1 pc.
0000SE0204UF	Grey plastic bucket 4 L with green upper plastic handle	1 pc.
0000SE1222B	Red plastic bucket 20 L with plastic handle	1 pc.
0000SE1322A	TOP-DOWN® - blue plastic bucket 20 L with plastic handle and hermetic cover	1 pc.
0000SE1322B	TOP-DOWN® - red plastic bucket 20 L with plastic handle and hermetic cover	1 pc.
0000SM00165	Set of T-shaped light grey closing plugs for vertical frames (6 pcs)	2 pcs
3048	Set of 3 stickers for buckets	1 pc.
P066061U	Long base with wheels ø 125 mm	1 pc.
P1191100U	Side plastic basket	1 pc.
P1229906U	Grey plastic drawer 22 L without key	1 pc.
P165000U	Base extension for Alpha trolleys and for the bag supporting plastic plate of the Morgan Hotel Elegance trolleys	2 pcs
P190360U	Plastic lid for Click Safe system	1 pc.
P1909937U	Plastic lift for buckets, with holes for bottles, fitting drawers 22 and 40 L	1 pc.
P2039903E	Vertical frame, 1 side with slides + 1 side for T-plugs, complete with screws and plugs	2 pcs
P2229906U	Plastic drawer 22 L with lock	1 pc.
P2909912U	Divider for bag holder 150 L	1 pc.
P2909920U	Closing profile for central basket and central bag holder, with screws and plugs	1 pc.
P2909946A	Blue cover for bag holder 150 L with check list holder	1 pc.
P3059953E	Fixed side wall with fixing pins	3 pcs
P3059954E	Right door with fixing pins	1 pc.
P3199903U	Central ring for 4 l buckets complete with lockable grey lid and 2 pistons	1 pc.
P8269907U	150l waste bag holder for Alpha standard and 90l for Alpha with Split system, with adjustable push handle, male fitting, with hooks, pistons, screws and plugs	1 pc.

⚠ ACCESSORIES TO BE ORDERED SEPARATELY

0000AT0160A	Plastified bag 56x92 cm, capacity 80 L, blu	1 pc.
0000AT0160B	Plastified bag 56x92 cm, capacity 80 L, red	1 pc.

ON REQUEST, WITH SURCHARGE

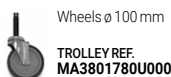

0000SE0104A	Blue plastic bucket 4 L with plastic handle	1 pc.
0000SE0104A	Red plastic bucket 4 L with plastic handle	1 pc.
0000SE0104C	Yellow plastic bucket 4 L with plastic handle	1 pc.
0000SE0104F	Green plastic bucket 4 L with plastic handle	1 pc.
0000SE1322A	TOP-DOWN® - blue plastic bucket 20 L with plastic handle and hermetic cover	1 pc.
0000SE1322B	TOP-DOWN® - red plastic bucket 20 L with plastic handle and hermetic cover	1 pc.
0000SM00165	Set of T-shaped light grey closing plugs for vertical frames (6 pcs)	2 pcs
0000SM00617	Quick connection kit Link-Up (4 pcs)	1 pc.
3048	Set of 3 stickers for buckets	1 pc.
P025061U	Compact base with wheels ø 125 mm	1 pc.
P059061U	Short base with wheels ø 125 mm	1 pc.
P1191100U	Side plastic basket	1 pc.
P1229906U	Grey plastic drawer 22 L without key	1 pc.
P165001U	Extension for Alpha trolleys	1 pc.
P1909968U	Covering for bag holder 150L, foldable bag holder 120L and closing profiles	1 pc.
P2039903E	Vertical frame, 1 side with slides + 1 side for T-plugs, complete with screws and plugs	3 pcs
P2199906U	Central plastic basket (female-female version) with plugs	1 pc.
P2909912U	Divider for bag holder 150 L	1 pc.
P2909920U	Closing profile for central basket and central bag holder, with screws and plugs	1 pc.
P2909921U	Closing profile with push-grip for central basket and central bag holder complete with screws and plugs	1 pc.
P2909946A	Blue cover for bag holder 150 L with check list holder	1 pc.
P3059953E	Fixed side wall with fixing pins	3 pcs
P3059954E	Right door with fixing pins	1 pc.
P3909952E	Door with fixing pins for bag holder	1 pc.
P8169905U	150-liter bag holder for Alpha standard and 90-liter for Alpha with Split system, male version, with hooks, pistons, screws and plugs	1 pc.

⚠ ACCESSORIES TO BE ORDERED SEPARATELY

0000AT0160A	Plastified bag 56x92 cm, capacity 80 L, blu	1 pc.
0000AT0160B	Plastified bag 56x92 cm, capacity 80 L, red	1 pc.
P2909962U	Pedal kit for Alpha trolleys with large, mini or supporting plate, 150 lt bag holder and ø 125 mm wheels	1 pc.

ON REQUEST, WITH SURCHARGE



PRODUCT PARTIALLY MADE OF PLASTIC COMPONENTS CERTIFIED PSV - PLASTIC SECOND LIFE



ALPHA

MORGAN

CHROMED AND RILSAN COATED TROLLEYS

ALPHA 5806703 - plastic trolley

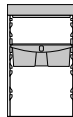

REF.	PCK	VOLUME (m³)	GROSS WEIGHT (kg)	SIZE (cm)
MA5806703U000	1	0,485	30,89	127x58x114

0000SE0104A	Blue plastic bucket 4 L with plastic handle	1 pc.
0000SE0104A	Red plastic bucket 4 L with plastic handle	1 pc.
0000SE1322A	TOP-DOWN® - blue plastic bucket 20 L with plastic handle and hermetic cover	1 pc.
0000SE1322B	TOP-DOWN® - red plastic bucket 20 L with plastic handle and hermetic cover	1 pc.
0000SM00165	Set of T-shaped light grey closing plugs for vertical frames (6 pcs)	2 pcs
P066061U	Long base with wheels ø 125 mm	1 pc.
P1191100U	Side plastic basket	2 pcs
P1229906U	Grey plastic drawer 22 L without key	1 pc.
P2039903E	Vertical frame, 1 side with slides + 1 side for T-plugs, complete with screws and plugs	2 pcs
P2199926UT	Central basket (female-female version) with divider, transparent cover, screws and plugs	1 pc.
P2909912U	Divider for bag holder 150 L	1 pc.
P2909920U	Closing profile for central basket and central bag holder, with screws and plugs	1 pc.
P2909946A	Blue cover for bag holder 150 L with check list holder	1 pc.
P3059953E	Fixed side wall with fixing pins	3 pcs
P3059954E	Right door with fixing pins	1 pc.
P3909952E	Door with fixing pins for bag holder	1 pc.
P8169905U	150-liter bag holder for Alpha standard and 90-liter for Alpha with Split system, male version, with hooks, pistons, screws and plugs	1 pc.

ON REQUEST, WITH SURCHARGE



ALPHA 0806708 - plastic trolley

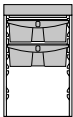
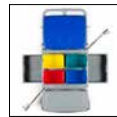

REF.	PCK	VOLUME (m³)	GROSS WEIGHT (kg)	SIZE (cm)
MA0806708U000	1	0,438	33,63	127x58x114

0000SE0104A	Blue plastic bucket 4 L with plastic handle	1 pc.
0000SE0104A	Red plastic bucket 4 L with plastic handle	1 pc.
0000SE0104C	Yellow plastic bucket 4 L with plastic handle	1 pc.
0000SE0104F	Green plastic bucket 4 L with plastic handle	1 pc.
0000SE1322A	TOP-DOWN® - blue plastic bucket 20 L with plastic handle and hermetic cover	1 pc.
0000SE1322B	TOP-DOWN® - red plastic bucket 20 L with plastic handle and hermetic cover	1 pc.
0000SM00165	Set of T-shaped light grey closing plugs for vertical frames (6 pcs)	2 pcs
3048	Set of 3 stickers for buckets	1 pc.
P066061U	Long base with wheels ø 125 mm	1 pc.
P1191100U	Side plastic basket	2 pcs
P1229906U	Grey plastic drawer 22 L without key	2 pcs
P2039903E	Vertical frame, 1 side with slides + 1 side for T-plugs, complete with screws and plugs	2 pcs
P2199906U	Central plastic basket (female-female version) with plugs	1 pc.
P2909912U	Divider for bag holder 150 L	1 pc.
P2909920U	Closing profile for central basket and central bag holder, with screws and plugs	1 pc.
P2909946A	Blue cover for bag holder 150 L with check list holder	1 pc.
P3059953E	Fixed side wall with fixing pins	2 pcs
P3059954E	Right door with fixing pins	2 pcs
P3909952E	Door with fixing pins for bag holder	1 pc.
P8169905U	150-liter bag holder for Alpha standard and 90-liter for Alpha with Split system, male version, with hooks, pistons, screws and plugs	1 pc.

ACCESSORIES TO BE ORDERED SEPARATELY

0000AT0160A	Plastified bag 56x92 cm, capacity 80 L, blu	1 pc.
0000AT0160B	Plastified bag 56x92 cm, capacity 80 L, red	1 pc.
P2909962U	Pedal kit for Alpha trolleys with large, mini or supporting plate, 150 lt bag holder and ø 125 mm wheels	1 pc.

ON REQUEST, WITH SURCHARGE



Multipurpose trolleys



ALPHA

MORGAN

CHROMED AND RILSAN COATED TROLLEYS

ALPHA 0806819 - plastic trolley with Split system

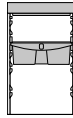

REF.	PCK	VOLUME (m³)	GROSS WEIGHT (kg)	SIZE (cm)
MA0806819U000	1	0,698	42,7	125x65x118

0000SE0104A	Blue plastic bucket 4 L with plastic handle	1 pc.
0000SE0104A	Red plastic bucket 4 L with plastic handle	1 pc.
0000SE0104C	Yellow plastic bucket 4 L with plastic handle	1 pc.
0000SE0104F	Green plastic bucket 4 L with plastic handle	1 pc.
0000SE1322A	TOP-DOWN® - blue plastic bucket 20 L with plastic handle and hermetic cover	1 pc.
0000SE1322B	TOP-DOWN® - red plastic bucket 20 L with plastic handle and hermetic cover	1 pc.
0000SM00165	Set of T-shaped light grey closing plugs for vertical frames (6 pcs)	2 pcs
3048	Set of 3 stickers for buckets	1 pc.
P065060U	Supporting plastic plate with two wheels Ø 125 mm to fix to Alpha base	1 pc.
P066061U	Long base with wheels Ø 125 mm	1 pc.
P1229906U	Grey plastic drawer 22 L without key	1 pc.
P2039903E	Vertical frame, 1 side with slides + 1 side for T-plugs, complete with screws and plugs	2 pcs
P2059963E	Door for Alpha bag holder with Split system	1 pc.
P2199906U	Central plastic basket (female-female version) with plugs	1 pc.
P2229913U	33L plastic drawer with lock for Alpha with Split system	1 pc.
P2229914U	Removable plastic shelf for Alpha with Split system	1 pc.
P2909912U	Divider for bag holder 150 L	1 pc.
P2909920U	Closing profile for central basket and central bag holder, with screws and plugs	1 pc.
P2909946A	Blue cover for bag holder 150 L with check list holder	1 pc.
P2909966U	Bag holder insert with storage compartment and divider for Alpha with Split system	1 pc.
P3059953E	Fixed side wall with fixing pins	1 pc.
P3059954E	Right door with fixing pins	1 pc.
P3059967E	Set walls, right and left, for Alpha with Split system	1 pc.
P8169905U	150-liter bag holder for Alpha standard and 90-liter for Alpha with Split system, male version, with hooks, pistons, screws and plugs	1 pc.
R2200040	Rilsan coated bucket holder for buckets 10 and 20 L fitting Morgan vertical frame and Alpha trolley	1 pc.
R3030162	Rilsan coated trolley kit with wheels Ø 200 mm with trolley locking device and fixing hooks for Top-Down buckets 10 L and 20 L	1 pc.

ACCESSORIES TO BE ORDERED SEPARATELY

0000AT0310A	Blue plastified bag 45 L, 32x23x63 cm	1 pc.
0000AT0310B	Red plastified bag 45 L, 32x23x63 cm	1 pc.
P2909962U	Pedal kit for Alpha trolleys with large, mini or supporting plate, 150 lt bag holder and Ø 125 mm wheels	1 pc.

ON REQUEST, WITH SURCHARGE



ALPHA 3806719 - plastic trolley

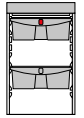
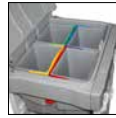

REF.	PCK	VOLUME (m³)	GROSS WEIGHT (kg)	SIZE (cm)
MA3806719U000	1	0,582	44,93	125x65x118

0000SE0204UA	Grey plastic bucket 4 L with blue upper plastic handle	1 pc.
0000SE0204UB	Grey plastic bucket 4 L with red upper plastic handle	1 pc.
0000SE0204UC	Grey plastic bucket 4 L with yellow upper plastic handle	1 pc.
0000SE0204UF	Grey plastic bucket 4 L with green upper plastic handle	1 pc.
0000SE1322A	TOP-DOWN® - blue plastic bucket 20 L with plastic handle and hermetic cover	1 pc.
0000SE1322B	TOP-DOWN® - red plastic bucket 20 L with plastic handle and hermetic cover	1 pc.
0000SM00165	Set of T-shaped light grey closing plugs for vertical frames (6 pcs)	2 pcs
3048	Set of 3 stickers for buckets	1 pc.
P065060U	Supporting plastic plate with two wheels Ø 125 mm to fix to Alpha base	1 pc.
P066061U	Long base with wheels Ø 125 mm	1 pc.
P1229906U	Grey plastic drawer 22 L without key	1 pc.
P1909937U	Plastic lift for buckets, with holes for bottles, fitting drawers 22 and 40 L	1 pc.
P2039903E	Vertical frame, 1 side with slides + 1 side for T-plugs, complete with screws and plugs	2 pcs
P2229906U	Plastic drawer 22 L with lock	1 pc.
P2909912U	Divider for bag holder 150 L	1 pc.
P2909920U	Closing profile for central basket and central bag holder, with screws and plugs	1 pc.
P2909946A	Blue cover for bag holder 150 L with check list holder	1 pc.
P3059953E	Fixed side wall with fixing pins	3 pcs
P3059954E	Right door with fixing pins	1 pc.
P3199903U	Central ring for 4 l buckets complete with lockable grey lid and 2 pistons	1 pc.
P3909952E	Door with fixing pins for bag holder	1 pc.
P8169905U	150-liter bag holder for Alpha standard and 90-liter for Alpha with Split system, male version, with hooks, pistons, screws and plugs	1 pc.
R2200040	Rilsan coated bucket holder for buckets 10 and 20 L fitting Morgan vertical frame and Alpha trolley	1 pc.
R3030162	Rilsan coated trolley kit with wheels Ø 200 mm with trolley locking device and fixing hooks for Top-Down buckets 10 L and 20 L	1 pc.

ACCESSORIES TO BE ORDERED SEPARATELY

0000AT0160A	Plastified bag 56x92 cm, capacity 80 L, blu	1 pc.
0000AT0160B	Plastified bag 56x92 cm, capacity 80 L, red	1 pc.
P2909962U	Pedal kit for Alpha trolleys with large, mini or supporting plate, 150 lt bag holder and Ø 125 mm wheels	1 pc.

ON REQUEST, WITH SURCHARGE



PRODUCT PARTIALLY MADE OF PLASTIC COMPONENTS CERTIFIED PSV - PLASTIC SECOND LIFE



ALPHA

MORGAN

CHROMED AND RILSAN COATED TROLLEYS

ALPHA 3806809 - plastic trolley with Split system



Equodose®
NOT INCLUDED

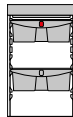
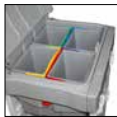

REF.	PCK	VOLUME (m³)	GROSS WEIGHT (kg)	SIZE (cm)
MA3806809UD00	1	0,488	38,5	138x58x120

0000SE0204UA	Grey plastic bucket 4 L with blue upper plastic handle	1 pc.
0000SE0204UB	Grey plastic bucket 4 L with red upper plastic handle	1 pc.
0000SE0204UC	Grey plastic bucket 4 L with yellow upper plastic handle	1 pc.
0000SE0204UF	Grey plastic bucket 4 L with green upper plastic handle	1 pc.
0000SE1322A	TOP-DOWN® - blue plastic bucket 20 L with plastic handle and hermetic cover	1 pc.
0000SM00165	Set of T-shaped light grey closing plugs for vertical frames (6 pcs)	2 pcs
3048	Set of 3 stickers for buckets	1 pc.
P066061U	Long base with wheels ø 125 mm	1 pc.
P1229906U	Grey plastic drawer 22 L without key	1 pc.
P1909937U	Plastic lift for buckets, with holes for bottles, fitting drawers 22 and 40 L	1 pc.
P2039908E	Vertical frame 1 side with slides + 1 side T-plugs with reinforcements, screws and plugs	2 pcs
P2059963E	Door for Alpha bag holder with Split system	1 pc.
P2229906U	Plastic drawer 22 L with lock	1 pc.
P2229913U	33L plastic drawer with lock for Alpha with Split system	1 pc.
P2229914U	Removable plastic shelf for Alpha with Split system	1 pc.
P2909912U	Divider for bag holder 150 L	1 pc.
P2909920U	Closing profile for central basket and central bag holder, with screws and plugs	1 pc.
P2909946A	Blue cover for bag holder 150 L with check list holder	1 pc.
P2909966U	Bag holder insert with storage compartment and divider for Alpha with Split system	1 pc.
P3059953E	Fixed side wall with fixing pins	1 pc.
P3059954E	Right door with fixing pins	1 pc.
P3059967E	Set walls, right and left, for Alpha with Split system	1 pc.
P3199903U	Central ring for 4 l buckets complete with lockable grey lid and 2 pistons	1 pc.
P8169905U	150-liter bag holder for Alpha standard and 90-liter for Alpha with Split system, male version, with hooks, pistons, screws and plugs	1 pc.
R1200042	Bucket holder in Rilsan for 10/20 L buckets	1 pc.

ACCESSORIES TO BE ORDERED SEPARATELY

0000AT0310A	Blue plastified bag 45 L , 32x23x63 cm	1 pc.
0000AT0310B	Red plastified bag 45 L , 32x23x63 cm	1 pc.
P2909962U	Pedal kit for Alpha trolleys with large, mini or supporting plate, 150 lt bag holder and ø 125 mm wheels	1 pc.
P320100UA	EQUODOSE - dosing device with one tank 6L for mop soaking on demand, with EPDM washers	1 pc.

ON REQUEST, WITH SURCHARGE



ALPHA 0806732 - plastic trolley with Click Safe system

NEW



Equodose®
NOT INCLUDED

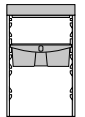

REF.	PCK	VOLUME (m³)	GROSS WEIGHT (kg)	SIZE (cm)
MA0806732UD00	1	0,488	32,84	141x58x120

Click Safe system requires the use of the corresponding Click Safe folding mop holder (See the catalog under the line Soaking and Floor Washing Systems - system with pockets)

0000SE0104A	Blue plastic bucket 4 L with plastic handle	1 pc.
0000SE0104A	Red plastic bucket 4 L with plastic handle	1 pc.
0000SE0104C	Yellow plastic bucket 4 L with plastic handle	1 pc.
0000SE0104F	Green plastic bucket 4 L with plastic handle	1 pc.
0000SE1222B	Red plastic bucket 20 L with plastic handle	1 pc.
0000SM00165	Set of T-shaped light grey closing plugs for vertical frames (6 pcs)	2 pcs
3048	Set of 3 stickers for buckets	1 pc.
P066061U	Long base with wheels ø 125 mm	1 pc.
P1229906U	Grey plastic drawer 22 L without key	1 pc.
P190360U	Plastic lid for Click Safe system	1 pc.
P2039908E	Vertical frame 1 side with slides + 1 side T-plugs with reinforcements, screws and plugs	2 pcs
P2199906U	Central plastic basket (female-female version) with plugs	1 pc.
P2909912U	Divider for bag holder 150 L	1 pc.
P2909920U	Closing profile for central basket and central bag holder, with screws and plugs	1 pc.
P2909946A	Blue cover for bag holder 150 L with check list holder	1 pc.
P3059953E	Fixed side wall with fixing pins	3 pcs
P3059954E	Right door with fixing pins	1 pc.
P3909952E	Door with fixing pins for bag holder	1 pc.
P8169905U	150-liter bag holder for Alpha standard and 90-liter for Alpha with Split system, male version, with hooks, pistons, screws and plugs	1 pc.
R2200045	Rilsan coated bucket holder with ø 80 mm wheel for Top-Down	1 pc.

ACCESSORIES TO BE ORDERED SEPARATELY

0000AT0160A	Plastified bag 56x92 cm, capacity 80 L, blu	1 pc.
0000AT0160B	Plastified bag 56x92 cm, capacity 80 L, red	1 pc.
P2909962U	Pedal kit for Alpha trolleys with large, mini or supporting plate, 150 lt bag holder and ø 125 mm wheels	1 pc.
P320100UA	EQUODOSE - dosing device with one tank 6L for mop soaking on demand, with EPDM washers	1 pc.

ON REQUEST, WITH SURCHARGE



Multipurpose trolleys



ALPHA

MORGAN

CHROMED AND RILSAN COATED TROLLEYS

ALPHA 3806781 - plastic trolley with Click Safe system

NEW



Equodose®
NOT INCLUDED



Door for
bag holder
NOT INCLUDED

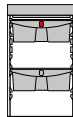

REF.	PCK	VOLUME (m³)	GROSS WEIGHT (kg)	SIZE (cm)
MA3806781UD00	1	0,485	34,29	157x58x110

ALPHA 5806709 - plastic trolley



Equodose®
NOT INCLUDED

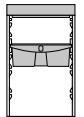

REF.	PCK	VOLUME (m³)	GROSS WEIGHT (kg)	SIZE (cm)
MA5806709UD00	1	0,488	32,14	138x58x120

Click Safe system requires the use of the corresponding Click Safe folding mop holder (See the catalog under the line Soaking and Floor Washing Systems - system with pockets)

0000SE0204UA	Grey plastic bucket 4 L with blue upper plastic handle	1 pc.
0000SE0204UB	Grey plastic bucket 4 L with red upper plastic handle	1 pc.
0000SE0204UC	Grey plastic bucket 4 L with yellow upper plastic handle	1 pc.
0000SE0204UF	Grey plastic bucket 4 L with green upper plastic handle	1 pc.
0000SE1222B	Red plastic bucket 20 L with plastic handle	1 pc.
0000SE1322A	TOP-DOWN® - blue plastic bucket 20 L with plastic handle and hermetic cover	1 pc.
0000SM00165	Set of T-shaped light grey closing plugs for vertical frames (6 pcs)	2 pcs
3048	Set of 3 stickers for buckets	1 pc.
P066061U	Long base with wheels ø 125 mm	1 pc.
P1229906U	Grey plastic drawer 22 L without key	1 pc.
P165000U	Base extension for Alpha trolleys and for the bag supporting plastic plate of the Morgan Hotel Elegance trolleys	1 pc.
P190360U	Plastic lid for Click Safe system	1 pc.
P1909937U	Plastic lift for buckets, with holes for bottles, fitting drawers 22 and 40 L	1 pc.
P2039908E	Vertical frame 1 side with slides + 1 side T-plugs with reinforcements, screws and plugs	2 pcs
P2229906U	Plastic drawer 22 L with lock	1 pc.
P2909912U	Divider for bag holder 150 L	1 pc.
P2909920U	Closing profile for central basket and central bag holder, with screws and plugs	1 pc.
P2909946A	Blue cover for bag holder 150 L with check list holder	1 pc.
P3059953E	Fixed side wall with fixing pins	3 pcs
P3059954E	Right door with fixing pins	1 pc.
P3199903U	Central ring for 4 l buckets complete with lockable grey lid and 2 pistons	1 pc.
P8269907U	150l waste bag holder for Alpha standard and 90l for Alpha with Split system, with adjustable push handle, male fitting, with hooks, pistons, screws and plugs	1 pc.
R1200042	Bucket holder in Rilsan for 10/20 L buckets	1 pc.

ACCESSORIES TO BE ORDERED SEPARATELY

0000AT0160A	Plastified bag 56x92 cm, capacity 80 L, blu	1 pc.
0000AT0160B	Plastified bag 56x92 cm, capacity 80 L, red	1 pc.
P320100UA	EQUODOSE - dosing device with one tank 6L for mop soaking on demand, with EPDM washers	1 pc.

ON REQUEST, WITH SURCHARGE

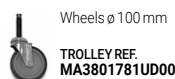

0000SE0104A	Blue plastic bucket 4 L with plastic handle	1 pc.
0000SE0104A	Red plastic bucket 4 L with plastic handle	1 pc.
0000SE1322A	TOP-DOWN® - blue plastic bucket 20 L with plastic handle and hermetic cover	1 pc.
0000SM00165	Set of T-shaped light grey closing plugs for vertical frames (6 pcs)	2 pcs
P066061U	Long base with wheels ø 125 mm	1 pc.
P1229906U	Grey plastic drawer 22 L without key	1 pc.
P2039908E	Vertical frame 1 side with slides + 1 side T-plugs with reinforcements, screws and plugs	2 pcs
P2199926UT	Central basket (female-female version) with divider, transparent cover, screws and plugs	1 pc.
P2909912U	Divider for bag holder 150 L	1 pc.
P2909920U	Closing profile for central basket and central bag holder, with screws and plugs	1 pc.
P2909946A	Blue cover for bag holder 150 L with check list holder	1 pc.
P3059953E	Fixed side wall with fixing pins	3 pcs
P3059954E	Right door with fixing pins	1 pc.
P3909952E	Door with fixing pins for bag holder	1 pc.
P8169905U	150-liter bag holder for Alpha standard and 90-liter for Alpha with Split system, male version, with hooks, pistons, screws and plugs	1 pc.
R1200042	Bucket holder in Rilsan for 10/20 L buckets	1 pc.

ACCESSORIES TO BE ORDERED SEPARATELY

0000AT0160A	Plastified bag 56x92 cm, capacity 80 L, blu	1 pc.
0000AT0160B	Plastified bag 56x92 cm, capacity 80 L, red	1 pc.
P2909962U	Pedal kit for Alpha trolleys with large, mini or supporting plate, 150 l bag holder and ø 125 mm wheels	1 pc.
P320100UA	EQUODOSE - dosing device with one tank 6L for mop soaking on demand, with EPDM washers	1 pc.

ON REQUEST, WITH SURCHARGE



PRODUCT PARTIALLY MADE OF PLASTIC COMPONENTS CERTIFIED PSV - PLASTIC SECOND LIFE



ALPHA

MORGAN

CHROMED AND RILSAN COATED TROLLEYS

ALPHA 3806710 - plastic trolley



Equodose®
NOT INCLUDED

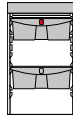
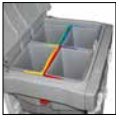

REF.	PCK	VOLUME (m³)	GROSS WEIGHT (kg)	SIZE (cm)
MA3806710UD00	1	0,488	31,44	136x58x110

0000SE0204UA	Grey plastic bucket 4 L with blue upper plastic handle	1 pc.
0000SE0204UB	Grey plastic bucket 4 L with red upper plastic handle	1 pc.
0000SE0204UC	Grey plastic bucket 4 L with yellow upper plastic handle	1 pc.
0000SE0204UF	Grey plastic bucket 4 L with green upper plastic handle	1 pc.
0000SE1322A	TOP-DOWN® - blue plastic bucket 20 L with plastic handle and hermetic cover	1 pc.
0000SM00165	Set of T-shaped light grey closing plugs for vertical frames (6 pcs)	2 pcs
3048	Set of 3 stickers for buckets	1 pc.
P066061U	Long base with wheels ø 125 mm	1 pc.
P075060U	Supporting plastic plate with 1 wheel ø 125 mm	1 pc.
P1229906U	Grey plastic drawer 22 L without key	1 pc.
P1901109U	Blocking plug for supporting plastic plate	2 pcs
P1909937U	Plastic lift for buckets, with holes for bottles, fitting drawers 22 and 40 L	1 pc.
P2039908E	Vertical frame 1 side with slides + 1 side T-plugs with reinforcements, screws and plugs	2 pcs
P2229906U	Plastic drawer 22 L with lock	1 pc.
P2909912U	Divider for bag holder 150 L	1 pc.
P2909920U	Closing profile for central basket and central bag holder, with screws and plugs	1 pc.
P2909946A	Blue cover for bag holder 150 L with check list holder	1 pc.
P3059953E	Fixed side wall with fixing pins	3 pcs
P3059954E	Right door with fixing pins	1 pc.
P3199903U	Central ring for 4 l buckets complete with lockable grey lid and 2 pistons	1 pc.
P3909952E	Door with fixing pins for bag holder	1 pc.
P8169905U	150-liter bag holder for Alpha standard and 90-liter for Alpha with Split system, male version, with hooks, pistons, screws and plugs	1 pc.

⚠ ACCESSORIES TO BE ORDERED SEPARATELY

0000AT0160A	Plastified bag 56x92 cm, capacity 80 L, blu	1 pc.
0000AT0160B	Plastified bag 56x92 cm, capacity 80 L, red	1 pc.
P2909962U	Pedal kit for Alpha trolleys with large, mini or supporting plate, 150 lt bag holder and ø 125 mm wheels	1 pc.
P320200UA	EQUODOSE - double dosing device for mop soaking on demand, with 2 tanks 6L end EPDM washer	1 pc.

ON REQUEST, WITH SURCHARGE



ALPHA MR3806814 - plastic trolley with Split and Link-Up system



Equodose®
NOT INCLUDED

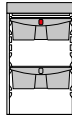
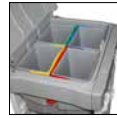

REF.	PCK	VOLUME (m³)	GROSS WEIGHT (kg)	SIZE (cm)
MR3806814UD00	1	0,642	49,5	146x58x117

0000SE0204UA	Grey plastic bucket 4 L with blue upper plastic handle	1 pc.
0000SE0204UB	Grey plastic bucket 4 L with red upper plastic handle	1 pc.
0000SE0204UC	Grey plastic bucket 4 L with yellow upper plastic handle	1 pc.
0000SE0204UF	Grey plastic bucket 4 L with green upper plastic handle	1 pc.
0000SE1322A	TOP-DOWN® - blue plastic bucket 20 L with plastic handle and hermetic cover	1 pc.
0000SM00165	Set of T-shaped light grey closing plugs for vertical frames (6 pcs)	2 pcs
0000SM00617	Quick connection kit Link-Up (4 pcs)	1 pc.
3048	Set of 3 stickers for buckets	1 pc.
P025061U	Compact base with wheels ø 125 mm	1 pc.
P1229906U	Grey plastic drawer 22 L without key	1 pc.
P159061U	Short base with 5 wheels ø 125 mm	1 pc.
P165001U	Extension for Alpha trolleys	1 pc.
P1909937U	Plastic lift for buckets, with holes for bottles, fitting drawers 22 and 40 L	1 pc.
P1909968U	Covering for bag holder 150L, foldable bag holder 120L and closing profiles	1 pc.
P2039906E	Vertical Frame, 1 smooth side + 1 side for T-plugs, complete with screws and plugs	1 pc.
P2039908E	Vertical frame 1 side with slides + 1 side T-plugs with reinforcements, screws and plugs	2 pcs
P2059963E	Door for Alpha bag holder with Split system	1 pc.
P2229906U	Plastic drawer 22 L with lock	1 pc.
P2229913U	33L plastic drawer with lock for Alpha with Split system	1 pc.
P2229914U	Removable plastic shelf for Alpha with Split system	1 pc.
P2909912U	Divider for bag holder 150 L	1 pc.
P2909920U	Closing profile for central basket and central bag holder, with screws and plugs	1 pc.
P2909921U	Closing profile with push-grip for central basket and central bag holder complete with screws and plugs	1 pc.
P2909946A	Blue cover for bag holder 150 L with check list holder	1 pc.
P3059953E	Fixed side wall with fixing pins	1 pc.
P3059954E	Right door with fixing pins	1 pc.
P3059967E	Set walls, right and left, for Alpha with Split system	1 pc.
P3199903U	Central ring for 4 l buckets complete with lockable grey lid and 2 pistons	1 pc.
P8169905U	150-liter bag holder for Alpha standard and 90-liter for Alpha with Split system, male version, with hooks, pistons, screws and plugs	1 pc.

⚠ ACCESSORIES TO BE ORDERED SEPARATELY

0000AT0310A	Blue plastified bag 45 L, 32x23x63 cm	1 pc.
0000AT0310B	Red plastified bag 45 L, 32x23x63 cm	1 pc.
P320100UA	EQUODOSE - dosing device with one tank 6L for mop soaking on demand, with EPDM washers	1 pc.

ON REQUEST, WITH SURCHARGE





ALPHA

MORGAN

CHROMED AND RILSAN COATED TROLLEYS

ALPHA 3806711 - plastic trolley



Equodose®
NOT INCLUDED

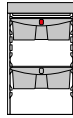
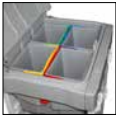

REF.	PCK	VOLUME (m³)	GROSS WEIGHT (kg)	SIZE (cm)
MA3806711UD00	1	0,488	35,64	153x58x110

0000SE0204UA	Grey plastic bucket 4 L with blue upper plastic handle	1 pc.
0000SE0204UB	Grey plastic bucket 4 L with red upper plastic handle	1 pc.
0000SE0204UC	Grey plastic bucket 4 L with yellow upper plastic handle	1 pc.
0000SE0204UF	Grey plastic bucket 4 L with green upper plastic handle	1 pc.
0000SE1322A	TOP-DOWN® - blue plastic bucket 20 L with plastic handle and hermetic cover	1 pc.
0000SE1322B	TOP-DOWN® - red plastic bucket 20 L with plastic handle and hermetic cover	1 pc.
0000SM00165	Set of T-shaped light grey closing plugs for vertical frames (6 pcs)	2 pcs
3048	Set of 3 stickers for buckets	1 pc.
P066061U	Long base with wheels ø 125 mm	1 pc.
P1229906U	Grey plastic drawer 22 L without key	1 pc.
P165001U	Extension for Alpha trolleys	1 pc.
P1909937U	Plastic lift for buckets, with holes for bottles, fitting drawers 22 and 40 L	1 pc.
P2039908E	Vertical frame 1 side with slides + 1 side T-plugs with reinforcements, screws and plugs	2 pcs
P2229906U	Plastic drawer 22 L with lock	1 pc.
P2909912U	Divider for bag holder 150 L	1 pc.
P2909920U	Closing profile for central basket and central bag holder, with screws and plugs	1 pc.
P2909946A	Blue cover for bag holder 150 L with check list holder	1 pc.
P3059953E	Fixed side wall with fixing pins	3 pcs
P3059954E	Right door with fixing pins	1 pc.
P3199903U	Central ring for 4 l buckets complete with lockable grey lid and 2 pistons	1 pc.
P3909952E	Door with fixing pins for bag holder	1 pc.
P515060U	Supporting plate with 2 wheels ø 125 mm and 2 blocking clips	1 pc.
P8169905U	150-liter bag holder for Alpha standard and 90-liter for Alpha with Split system, male version, with hooks, pistons, screws and plugs	1 pc.

⚠ ACCESSORIES TO BE ORDERED SEPARATELY

0000AT0160A	Plastified bag 56x92 cm, capacity 80 L, blu	1 pc.
0000AT0160B	Plastified bag 56x92 cm, capacity 80 L, red	1 pc.
P2909962U	Pedal kit for Alpha trolleys with large, mini or supporting plate, 150 lt bag holder and ø 125 mm wheels	1 pc.
P320200UA	EQUODOSE - double dosing device for mop soaking on demand, with 2 tanks 6L end EPDM washer	1 pc.

ON REQUEST, WITH SURCHARGE



Rubber wheels
ø 125 mm
TROLLEY REF.
MA3803711UD00



Wheels ø 100 mm
TROLLEY REF.
MA3801711UD00



Bag holder with adjustable
push-grip
TROLLEY REF.
MA3806761UD00



PRODUCT PARTIALLY MADE OF PLASTIC COMPONENTS CERTIFIED PSV - PLASTIC SECOND LIFE



ALPHA

MORGAN

CHROMED AND RILSAN COATED TROLLEYS

Metal Free

ALPHA METAL FREE 0236704 - plastic trolley



ALPHA METAL FREE 3336700 - plastic trolley

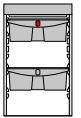

REF.	PCK	VOLUME (m³)	GROSS WEIGHT (kg)	SIZE (cm)
MX0236704U000	1	0,31	23,09	85x58x112

0000SE1322A	TOP-DOWN® - blue plastic bucket 20 L with plastic handle and hermetic cover	1 pc.
0000SE1322B	TOP-DOWN® - red plastic bucket 20 L with plastic handle and hermetic cover	1 pc.
0000SM00165	Set of T-shaped light grey closing plugs for vertical frames (6 pcs)	2 pcs
0000SM00639	Uni-Move 2 handle holder kit	1 pc.
P059361UX	Short plastic base with rubber wheels ø 125 mm for Alpha Metal Free trolley	1 pc.
P1191100U	Side plastic basket	2 pcs
P2039903EX	Vertical frame, 1 side with slides + 1 side for T-plugs, complete with screws and plugs	2 pcs
P2199906U	Central plastic basket (female-female version) with plugs	1 pc.
P2229906UX	Plastic sliding drawer 22 L with lock for Alpha Metal Free trolley	2 pcs
P2229907UX	Plastic sliding drawer 40 L with lock for Alpha Metal Free trolley	1 pc.
P2909920UX	Closing profile for central basket complete with screws and plugs for Alpha Metal Free trolley	1 pc.
P2909921UX	Closing profile with push-grip for central basket complete with screws and plugs for Alpha Metal Free trolley	1 pc.

REF.	PCK	VOLUME (m³)	GROSS WEIGHT (kg)	SIZE (cm)
MX3336700U007	1	0,372	28,27	118x58x110

0000SE0204UA	Grey plastic bucket 4 L with blue upper plastic handle	1 pc.
0000SE0204UB	Grey plastic bucket 4 L with red upper plastic handle	1 pc.
0000SE0204UC	Grey plastic bucket 4 L with yellow upper plastic handle	1 pc.
0000SE0204UF	Grey plastic bucket 4 L with green upper plastic handle	1 pc.
0000SE1322A	TOP-DOWN® - blue plastic bucket 20 L with plastic handle and hermetic cover	1 pc.
0000SE1322B	TOP-DOWN® - red plastic bucket 20 L with plastic handle and hermetic cover	1 pc.
0000SM00165	Set of T-shaped light grey closing plugs for vertical frames (6 pcs)	2 pcs
3048	Set of 3 stickers for buckets	1 pc.
P059361UX	Short plastic base with rubber wheels ø 125 mm for Alpha Metal Free trolley	1 pc.
P075000U	Supporting plastic plate for Alpha trolleys	1 pc.
P1191100U	Side plastic basket	2 pcs
P1229906UX	Plastic sliding drawer 22 L without lock for Alpha Metal Free trolley	1 pc.
P1909937U	Plastic lift for buckets, with holes for bottles, fitting drawers 22 and 40 L	1 pc.
P2039903EX	Vertical frame, 1 side with slides + 1 side for T-plugs, complete with screws and plugs	2 pcs
P206030U	1x40 L + 1x80 L plastic divider for plastic bag holder 120 L	1 pc.
P2229906UX	Plastic sliding drawer 22 L with lock for Alpha Metal Free trolley	1 pc.
P2909920UX	Closing profile for central basket complete with screws and plugs for Alpha Metal Free trolley	1 pc.
P3059953EX	Fixed side wall with fixing inserts for Alpha Metal Free trolley	1 pc.
P3059954EX	Right door with fixing pins for Alpha Metal Free	1 pc.
P3199903UX	Central ring for 4 l buckets complete with lockable grey lid and 2 pistons	1 pc.
P8161111UX	120l waste bag holder, male fitting, with hooks, screws and plugs for Alpha Metal Free trolley	1 pc.

⚠ ACCESSORIES TO BE ORDERED SEPARATELY

0000AT0160A	Plastified bag 56x92 cm, capacity 80 L, blu	1 pc.
0000AT0170B	Plastified bag 48x97 cm, capacity 60 L, red	1 pc.
P291918A	Blue cover for bag holder 120 L	1 pc.

MULTIPURPOSE TROLLEYS



PRODUCT PARTIALLY MADE OF PLASTIC COMPONENTS CERTIFIED PSV - PLASTIC SECOND LIFE

Multipurpose trolleys



ALPHA

MORGAN

CHROMED AND RILSAN COATED TROLLEYS

Drive

ALPHA DRIVE 3848400 - plastic trolley

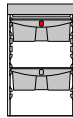

REF.	PCK	VOLUME (m³)	GROSS WEIGHT (kg)	SIZE (cm)
MA3848400U002	1	1,86	77,5	139x68x120

0000SE0204UA	Grey plastic bucket 4 L with blue upper plastic handle	1 pc.
0000SE0204UB	Grey plastic bucket 4 L with red upper plastic handle	1 pc.
0000SE0204UC	Grey plastic bucket 4 L with yellow upper plastic handle	1 pc.
0000SE0204UF	Grey plastic bucket 4 L with green upper plastic handle	1 pc.
0000SM00165	Set of T-shaped light grey closing plugs for vertical frames (6 pcs)	2 pcs
3048	Set of 3 stickers for buckets	1 pc.
7004A	REGULAR - blue plastic down-press wringer with plastic gears	1 pc.
8108A	Blue plastic bucket 15 L with plastic handle	1 pc.
8108B	Red plastic bucket 15 L with plastic handle	1 pc.
P066481U	Long base with 2 rubber wheels ø 200x50 mm and 2 bumpers complete with motor kit	1 pc.
P1229906U	Grey plastic drawer 22 L without key	1 pc.
P1909937U	Plastic lift for buckets, with holes for bottles, fitting drawers 22 and 40 L	1 pc.
P2039903E	Vertical frame, 1 side with slides + 1 side for T-plugs, complete with screws and plugs	2 pcs
P2229906U	Plastic drawer 22 L with lock	1 pc.
P2909912U	Divider for bag holder 150 L	1 pc.
P2909920U	Closing profile for central basket and central bag holder, with screws and plugs	1 pc.
P2909946A	Blue cover for bag holder 150 L with check list holder	1 pc.
P3059953E	Fixed side wall with fixing pins	3 pcs
P3059954E	Right door with fixing pins	1 pc.
P3199903U	Central ring for 4 l buckets complete with lockable grey lid and 2 pistons	1 pc.
P3909952E	Door with fixing pins for bag holder	1 pc.
P515590U	Supporting plate with two ø 200x50 mm rubber wheels and 2 blocking plugs	1 pc.
P8169905U	150-liter bag holder for Alpha standard and 90-liter for Alpha with Split system, male version, with hooks, pistons, screws and plugs	1 pc.
R1040010	Rilsan coated wringer support complete with screws	1 pc.

ACCESSORIES TO BE ORDERED SEPARATELY

0000AT0160A	Plastified bag 56x92 cm, capacity 80 L, blu	1 pc.
0000AT0160B	Plastified bag 56x92 cm, capacity 80 L, red	1 pc.
00BL1000	Lithium battery	1 pc.

ALPHA DRIVE 0848703 - plastic trolley

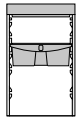

REF.	PCK	VOLUME (m³)	GROSS WEIGHT (kg)	SIZE (cm)
MA0848703U000	1	1,89	64	120x58x124

0000SE0104A	Blue plastic bucket 4 L with plastic handle	1 pc.
0000SE0104A	Red plastic bucket 4 L with plastic handle	1 pc.
0000SE0104C	Yellow plastic bucket 4 L with plastic handle	1 pc.
0000SE0104F	Green plastic bucket 4 L with plastic handle	1 pc.
0000SE1322A	TOP-DOWN® - blue plastic bucket 20 L with plastic handle and hermetic cover	1 pc.
0000SE1322B	TOP-DOWN® - red plastic bucket 20 L with plastic handle and hermetic cover	1 pc.
0000SM00165	Set of T-shaped light grey closing plugs for vertical frames (6 pcs)	2 pcs
3048	Set of 3 stickers for buckets	1 pc.
P1191100U	Side plastic basket	2 pcs
P1229906U	Grey plastic drawer 22 L without key	1 pc.
P2039903E	Vertical frame, 1 side with slides + 1 side for T-plugs, complete with screws and plugs	2 pcs
P2199906U	Central plastic basket (female-female version) with plugs	1 pc.
P266481U	Long base with 2 rubber wheels ø 200x50 mm and 4 bumpers complete with motor kit	1 pc.
P2909912U	Divider for bag holder 150 L	1 pc.
P2909920U	Closing profile for central basket and central bag holder, with screws and plugs	1 pc.
P2909946A	Blue cover for bag holder 150 L with check list holder	1 pc.
P3059953E	Fixed side wall with fixing pins	3 pcs
P3059954E	Right door with fixing pins	1 pc.
P3909952E	Door with fixing pins for bag holder	1 pc.
P8169905U	150-liter bag holder for Alpha standard and 90-liter for Alpha with Split system, male version, with hooks, pistons, screws and plugs	1 pc.

ACCESSORIES TO BE ORDERED SEPARATELY

0000AT0160A	Plastified bag 56x92 cm, capacity 80 L, blu	1 pc.
0000AT0160B	Plastified bag 56x92 cm, capacity 80 L, red	1 pc.
00BL1000	Lithium battery	1 pc.

MULTIPURPOSE TROLLEYS



PRODUCT PARTIALLY MADE OF PLASTIC COMPONENTS CERTIFIED PSV - PLASTIC SECOND LIFE



ALPHA

MORGAN

CHROMED AND RILSAN COATED TROLLEYS

ALPHA DRIVE 3848711 - plastic trolley



Equodose®
NOT INCLUDED

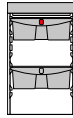
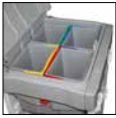

REF.	PCK	VOLUME (m³)	GROSS WEIGHT (kg)	SIZE (cm)
MA3848711UD00	1	1,86	79,7	153x58x120

0000SE0204UA	Grey plastic bucket 4 L with blue upper plastic handle	1 pc.
0000SE0204UB	Grey plastic bucket 4 L with red upper plastic handle	1 pc.
0000SE0204UC	Grey plastic bucket 4 L with yellow upper plastic handle	1 pc.
0000SE0204UF	Grey plastic bucket 4 L with green upper plastic handle	1 pc.
0000SE1322A	TOP-DOWN® - blue plastic bucket 20 L with plastic handle and hermetic cover	1 pc.
0000SE1322B	TOP-DOWN® - red plastic bucket 20 L with plastic handle and hermetic cover	1 pc.
0000SM00165	Set of T-shaped light grey closing plugs for vertical frames (6 pcs)	2 pcs
3048	Set of 3 stickers for buckets	1 pc.
P066481U	Long base with 2 rubber wheels ø 200x50 mm and 2 bumpers complete with motor kit	1 pc.
P1229906U	Grey plastic drawer 22 L without key	1 pc.
P165001U	Extension for Alpha trolleys	1 pc.
P1909937U	Plastic lift for buckets, with holes for bottles, fitting drawers 22 and 40 L	1 pc.
P2039908E	Vertical frame 1 side with slides + 1 side T-plugs with reinforcements, screws and plugs	2 pcs
P2229906U	Plastic drawer 22 L with lock	1 pc.
P2909912U	Divider for bag holder 150 L	1 pc.
P2909920U	Closing profile for central basket and central bag holder, with screws and plugs	1 pc.
P2909946A	Blue cover for bag holder 150 L with check list holder	1 pc.
P3059953E	Fixed side wall with fixing pins	3 pcs
P3059954E	Right door with fixing pins	1 pc.
P3199903U	Central ring for 4 l buckets complete with lockable grey lid and 2 pistons	1 pc.
P3909952E	Door with fixing pins for bag holder	1 pc.
P515590U	Supporting plate with two ø 200x50 mm rubber wheels and 2 blocking plugs	1 pc.
P8169905U	150-liter bag holder for Alpha standard and 90-liter for Alpha with Split system, male version, with hooks, pistons, screws and plugs	1 pc.

⚠ ACCESSORIES TO BE ORDERED SEPARATELY

0000AT0160A	Plastified bag 56x92 cm, capacity 80 L, blu	1 pc.
0000AT0160B	Plastified bag 56x92 cm, capacity 80 L, red	1 pc.
00BL1000	Lithium battery	1 pc.
P320200UA	EQUODOSE - double dosing device for mop soaking on demand, with 2 tanks 6L end EPDM washer	1 pc.



PRODUCT PARTIALLY MADE OF PLASTIC COMPONENTS CERTIFIED PSV - PLASTIC SECOND LIFE



ALPHA

MORGAN

CHROMED AND RILSAN COATED TROLLEYS

Components for Alpha trolleys

Compact base for Alpha trolley



REF.	NOTES	SIZE (cm) ↓ ↓ ↓
P025011U	with wheels ø 100 mm	55x52
P025031U	with rubber wheels ø 125 mm	55x52
P025061U	with wheels ø 125 mm	55x52

Short plastic base for Alpha trolley



REF.	NOTES	SIZE (cm) ↓ ↓ ↓
P059011U	with wheels ø 100 mm	66x52
P059031U	with rubber wheels ø 125 mm	66x52
P059061U	with wheels ø 125 mm	66x52
P159061U	with five ø 125 mm wheels	66x52

Small base for Alpha Metal Free Trolley



REF.	NOTES	SIZE (cm) ↓ ↓ ↓
P059361UX	with rubber wheels ø 125 mm	66x52

Long plastic base for Alpha trolley



REF.	NOTES	SIZE (cm) ↓ ↓ ↓
P066011U	with wheels ø 100 mm	91x52
P066031U	with rubber wheels ø 125 mm	91x52
P066061U	with wheels ø 125 mm	91x52
P166031U	with five ø 125 mm rubber wheels	91x52

Supporting plate with 2 wheels and 2 blocking plugs



REF.	NOTES
P515010U	with wheels ø 100 mm
P515030U	with rubber wheels ø 125 mm
P515060U	with wheels ø 125 mm

Blocking plug for supporting plastic plate



REF.	NOTES
P1901109U	

MULTIPURPOSE TROLLEYS



ALPHA

MORGAN

CHROMED AND RILSAN COATED TROLLEYS

Supporting plastic plate with 1 wheel



REF.	NOTES	SIZE (cm) ↓ ↓ ↓
P075060U	with wheel ø 125 mm	32x48

Supporting plastic plate for Alpha trolleys

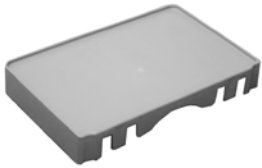

REF.	NOTES	SIZE (cm) ↓ ↓ ↓
P175000U		32x48x7

Base extension for Alpha trolleys and for the bag supporting plastic plate of the Morgan Hotel Elegance trolleys



REF.	NOTES	SIZE (cm) ↓ ↓ ↓
P165000U	without castors	22x48
P065060U	with 2 wheels ø 125 mm	22x48



Extension for Alpha trolleys



REF.	NOTES
P165001U	

Vertical frame with reinforcement, 2 sides with T-plugs, complete with screws



REF.	NOTES
P2031102U	

For trolleys with foldable bagholder and side baskets

Multipurpose trolleys



ALPHA

MORGAN

CHROMED AND RILSAN COATED TROLLEYS

Vertical frame with reinforcement, 1 smooth side + 1 side for T-plugs, complete with screws



REF.	NOTES
P2031103U	

Reinforced vertical frame, 1 side with slides + 1 side for T-plugs, complete with screws and plugs



REF.	NOTES
P2039908E	

Vertical frame, 1 side with slides + 1 side for T-plugs, complete with screws and plugs

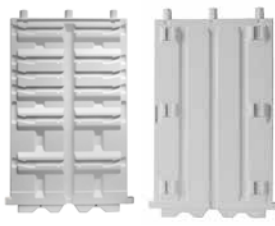

REF.	NOTES
P2039903E	

Vertical frame, 1 side with slides + 1 side for T-plugs, complete with screws and plugs

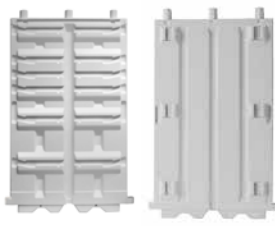

REF.	NOTES
P2039903EX	

Vertical frame, 2 sides with slides, complete with screws and plugs



REF.	NOTES
P2039904E	

MULTIPURPOSE TROLLEYS



ALPHA

MORGAN

CHROMED AND RILSAN COATED TROLLEYS

Vertical Frame, 1 smooth side + 1 side for T-plugs, complete with screws and plugs

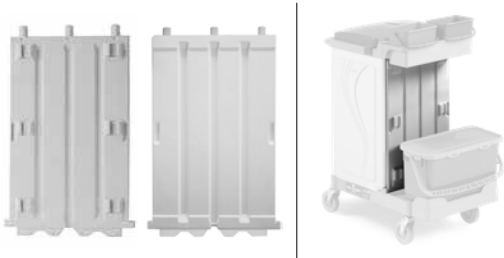

REF.	NOTES
P2039906E	

Vertical frame with reinforcement, 1 smooth side + 1 side for T-plugs, complete with screws

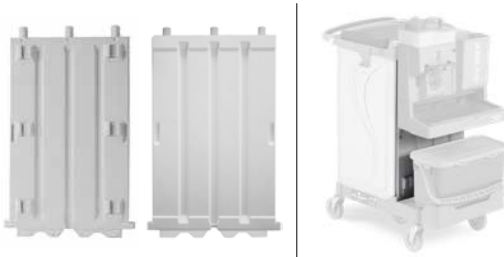

REF.	NOTES
P2039909E	

Quick connection kit Link-Up (4 pcs)



REF.	NOTES
000SM00617	

Set of T-shaped closing plugs for vertical frames (6 pcs)



REF.	NOTES
000SM00163	dark grey
000SM00165	light grey

Fixed side wall with fixing pins

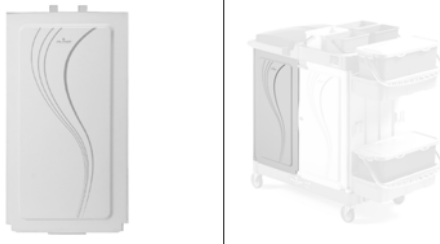

REF.	NOTES
P3059953E	

MULTIPURPOSE
TROLLEYS



ALPHA

MORGAN

CHROMED AND RILSAN COATED TROLLEYS

Fixed side wall with fixing inserts for Alpha Metal Free trolley



REF.	NOTES
P3059953EX	

Right door with fixing pins



REF.	NOTES
P3059954E	

Right door with fixing pins for Alpha Metal Free



REF.	NOTES
P3059954EX	

Left door with fixing pins



REF.	NOTES
P3059974E	

Door for 150l waste bag holder with fastening pins



REF.	NOTES
P3909952E	



ALPHA

MORGAN

CHROMED AND RILSAN COATED TROLLEYS

Set walls, right and left, for Alpha with Split system



REF.	NOTES
P3059967E	

Door for Alpha bag holder with Split system



REF.	NOTES
P2059963E	

Central plastic basket (female-female version) with plugs



REF.	NOTES
P2199906U	internal sizes 31x48x8 cm

Central plastic basket (male-female version) with screws and plugs



REF.	NOTES
P2199907U	internal sizes 31x48x8 cm

Central basket (female-female version) with divider and plugs



REF.	NOTES
P2199926U	with a grey cover
P2199926UT	with transparent cover
P2199936U	with 2 grey covers
P2199936UT	with 2 transparent covers



MULTIPURPOSE TROLLEYS



ALPHA

MORGAN

CHROMED AND RILSAN COATED TROLLEYS

Central basket (male-female version) with divider and plugs













REF.	NOTES
P2199927U	with a grey cover
P2199927UT	with transparent cover
P2199937U	with 2 grey covers
P2199937UT	with 2 transparent covers



Central ring for 4l buckets complete with lockable coloured lid, 2 soft-close pistons and 2 short supports for hooks and clips



REF.	NOTES
P3199903U	for trolleys with door 
P3199903UA	for trolleys with door 
P3199903UB	for trolleys with door 
P3199903UC	for trolleys with door 
P3199903UF	for trolleys with door 
P4199903U	for trolleys without door 
P4199903UA	for trolleys without door 
P4199903UB	for trolleys without door 
P4199903UC	for trolleys without door 
P4199903UF	for trolleys without door 





Central ring for 4 lt buckets for Alpha Metal Free trolley complete with lockable cover, 2 soft-close pistons and 2 short supports for hooks and clips



REF.	NOTES
P3199903UX	for trolleys with door 

Central ring for 8l buckets complete with lockable coloured lid, 2 soft-close pistons and 2 short supports for hooks and clips



REF.	NOTES
P3199905U	
P3199905UA	
P3199905UB	
P3199905UC	
P3199905UF	

Side plastic basket



REF.	NOTES
P1191100U	internal sizes 22x49x11,5 cm



ALPHA

MORGAN

CHROMED AND RILSAN COATED TROLLEYS

Upper basket



REF.	NOTES
P1199900U	internal sizes 14x49,5x11 cm

Closing profile for central basket and central bag holder, with screws and plugs



REF.	NOTES
P2909920U	

Closing profile for central basket complete with screws and plugs for Alpha Metal Free trolley



REF.	NOTES
P2909920UX	

Closing profile with push-grip for central basket and central bag holder complete with screws and plugs

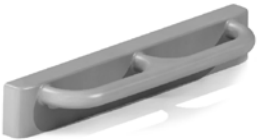

REF.	NOTES
P2909921U	

Closing profile with push-grip for central basket complete with screws and plugs for Alpha Metal Free trolley

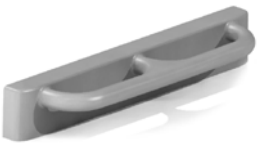

REF.	NOTES
P2909921UX	

Closing profile for vertical frame complete with screws and plugs



REF.	NOTES
P2909960U	

MULTIPURPOSE TROLLEYS



ALPHA

MORGAN

CHROMED AND RILSAN COATED TROLLEYS

Covering



REF.	NOTES
P1909967U	for fixed bag holder 120 L
P1909968U	for bag holder 150 L, foldable bag holder 120 L and profile

120l waste bag holder, with 2 fixed dustpan hooks, 2 handle clips and 2 Uni-Move clips

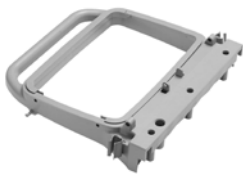

REF.	NOTES
P8161110U	female version
P8161111U	male version

120l waste bag holder for Alpha Metal Free trolley, with 2 fixed dustpan hooks, 2 handle clips and 2 Uni-Move clips

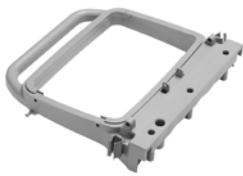

REF.	NOTES
P8161111UX	male version

120l waste bag holder with tray, with 2 fixed dustpan hooks, 2 handle clips, 2 Uni-Move clips, screws and plugs



REF.	NOTES
P8161112U	

Folding 120l waste bag holder, with bag retaining hooks, 2 fixed dustpan hooks, 1 handle clip, 2 Uni-Move clips, screws and plugs



REF.	NOTES
P8161113U	
P8161115U	for trolleys with central frame

150l waste bag holder, with 2 Uni-Move clips, 2 long supports with sign hook, 2 pistons, screws and plugs for Alpha 7103 trolley



REF.	NOTES
P8169900U	female version
P8169901U	male version



ALPHA

MORGAN

CHROMED AND RILSAN COATED TROLLEYS

150 lt bag holder for Alpha standard and 90 lt for Alpha with Split system, male version, with two Uni-Move hooks, 2 long supports with sign hooks, 2 pistons, screws and plugs



REF.	NOTES
P8169905U	

150 lt bag holder for Alpha standard and 90 lt for Alpha with Split system, with adjustable push handle, male version, with two Uni-Move hooks, 2 long supports with sign hooks, 2 pistons, screws and plugs

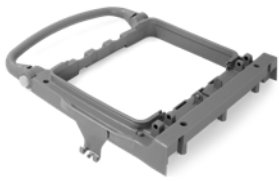

REF.	NOTES
P8269907U	

Central bag holder 150 L



REF.	NOTES
P8169903U	female/female version
P8169904U	male/female version

Set of 2 bag holders 150 L complete with screws and plugs

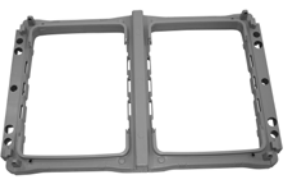

REF.	NOTES
P8169906U	

Rilsan 70l waste bag holder for mounting on vertical frame



REF.	NOTES
R2060031	

Stainless steel holder for 4 lt buckets to be applied to 150 lt bag holder

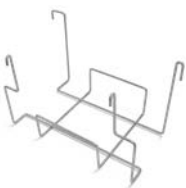

REF.	NOTES
I1050072	



ALPHA

MORGAN

CHROMED AND RILSAN COATED TROLLEYS

DUO PRO kit



REF.	NOTES	
0020SE2742U		
0000SE0717UA	17l plastic mop bucket, grey with blue handle	1 pc.
0000SE0725UB	Grey plastic bucket 25L with red handle	1 pc.
21040U	DUO PRO - lever plastic wringer	1 pc.
P165002U	Base extension for Duo Pro system	1 pc.
R2050071	Rilsan coated bucket holder for Duo Pro kit	1 pc.



HANDY - bin 70 L with drain plug, wheels and bag stretcher



REF.	NOTES	SIZE (cm) ↓ ↓ ↓
P391070E	with push-bar	51,5x56x86
P291070E	without push-bar	37x56x71

Advised bag size: 75x110 cm

Cover set complete with rubber lace, cage for deodorant pills and screws



REF.	NOTES
P290068E	

Assembling kit to fix Handy bin to Alpha vertical frame



REF.	NOTES
0000SM00610	





ALPHA

MORGAN

CHROMED AND RILSAN COATED TROLLEYS

Plastic shelf for AlphaSplit



REF.	NOTES
P2229914U	

33L plastic drawer with lock for Alpha with Split system



REF.	NOTES	CAPACITY (L)
P2229913U	interior dimensions 34x41x24 cm	33

Bag holder insert with storage compartment for Alpha with Split system



REF.	NOTES
P1909966U	

Bag holder insert with storage compartment and one divider for AlphaSplit



REF.	NOTES
P2909966U	

Bag holder insert with storage compartment and two dividers for Alpha with Split system



REF.	NOTES
P3909966U	

Set of plastic shelves (2 pcs)



REF.	NOTES	SIZE (cm) ↓ ↓ ↓
P1229900U		21,5x37,5x1,5

Multipurpose trolleys



ALPHA

MORGAN

CHROMED AND RILSAN COATED TROLLEYS





Plastic sliding drawer without locking key



REF.	NOTES	CAPACITY (L)	SIZE (cm) ↓ ↓ ↓
P1229909U	internal dimensions 41x34x9,5 cm	10	46,5x37,5x11
P1229906U	internal dimensions 40,5x34x16 cm	22	46,5x37,5x17
P1229907U	internal dimensions 40x34x33,5 cm	40	46,5x37,5x35

Plastic sliding drawer with locking key



REF.	NOTES	CAPACITY (L)	SIZE (cm) ↓ ↓ ↓
P2229909U	internal dimensions 41x34x9,5 cm 	10	46,5x37,5x11
P2229906A	internal dimensions 40,5x34x16 cm 	22	46,5x37,5x17
P2229906B	internal dimensions 40,5x34x16 cm 	22	46,5x37,5x17
P2229906U	internal dimensions 40,5x34x16 cm 	22	46,5x37,5x17
P2229907U	internal dimensions 40x34x33,5 cm 	40	46,5x37,5x35

Plastic sliding drawer without lock for Alpha Metal Free trolley



REF.	NOTES	CAPACITY (L)	SIZE (cm) ↓ ↓ ↓
P1229906UX	internal dimensions 40,5x34x16 cm	22	46,5x37,5x17
P1229907UX	internal dimensions 40x34x33,5 cm	40	46,5x37,5x35

Plastic sliding drawer with lock for Alpha Metal Free trolley



REF.	NOTES	CAPACITY (L)	SIZE (cm) ↓ ↓ ↓
P2229906UX	internal dimensions 40,5x34x16 cm	22	46,5x37,5x17
P2229907UX	internal dimensions 40x34x33,5 cm	40	46,5x37,5x35

Plastic lift for buckets, with holes for bottles, fitting drawers 22 and 40 L



REF.	NOTES
P1909937U	



ALPHA

MORGAN

CHROMED AND RILSAN COATED TROLLEYS

Rilsan coated wringer support complete with screws



REF.	NOTES
R1040010	

Rilsan coated fixing set for Fred trolley



REF.	NOTES
0000SM00606	

Rilsan coated trolley kit with wheels ø 200 mm with trolley locking device and fixing hooks, for Top-Down® buckets 10 and 20 L



REF.	NOTES	SIZE (cm)
R3030162		↓ ↓ ↓ 32x60x94

MULTIPURPOSE TROLLEYS

Fitting Alpha trolleys - Recommended with supporting plate cod. P065060U

Rilsan coated bucket holder for buckets 10 and 20 L fitting Morgan vertical frame and Alpha trolley

REF.	NOTES
R2200040	



Bucket holder in Rilsan for 10/20 L buckets

REF.	NOTES
R1200042	1. can be applied to the bottom position of the vertical frame
R1200044	2. can be applied to the top and middle position of the vertical frame





ALPHA

MORGAN

CHROMED AND RILSAN COATED TROLLEYS

Plastic lid for Click Safe system

NEW



REF.	NOTES	SIZE (cm) ↓ ↓ ↓
P190360U		55x23x12

Rilsan coated bucket holder for 10/20 liter buckets, to be applied at the base of Alpha trolleys

NEW



REF.	NOTES
R2200045	

Accessories for Alpha trolleys

Plastic rising support for basket art. P1191100U

REF.	NOTES
P1901112U	







Divider for plastic bag holder 120 L



REF.	NOTES
P206020U	2x60 L
P206030U	1x40 L + 1x80 L
P206040U	3x40 L



Plastic divider with square shaped insert for bag holder 120 L



REF.	NOTES
P306020U	2x60 L and 20 L square shaped insert
P406020U	2x60 L and two 20 L square shaped inserts



For Alpha, Emotion range bag holders and bag holder code P906010U, Morgan range



ALPHA

MORGAN

CHROMED AND RILSAN COATED TROLLEYS

Square plastic support 20 L for the divider of bag holder 120 L



REF.	NOTES
P1909957U	

For Alpha, Emotion range bag holders and bag holder code P906010U, Morgan range - Use recommended with net bags, code 0000AT0210

Divider for bag holder 150 L



REF.	NOTES
P2909912U	

Square plastic support 20 L for bag holder 150 L



REF.	NOTES
P1909926U	with right connection
P1909927U	with left connection

It is suggested the use of the specific net bags for washing art. 0000AT0210

Plastic divider 3x20 L for bag holder 150 L



REF.	NOTES
P1909914U	

It is suggested the use of the specific net bags for washing art. 0000AT0210

Plastic sliding tray with slide out limiter and key



REF.	NOTES
P3229915U	

Set of 1 big divider 39 cm + 1 medium divider 32 cm for plastic sliding drawer 22 L

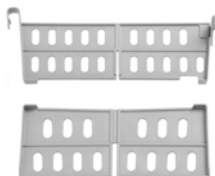

REF.	NOTES
0000SM00213U	

MULTIPURPOSE TROLLEYS

Multipurpose trolleys



ALPHA

MORGAN

CHROMED AND RILSAN COATED TROLLEYS

Set of 1 big divider 39 cm + 3 small dividers 16 cm for plastic sliding drawer 22 L

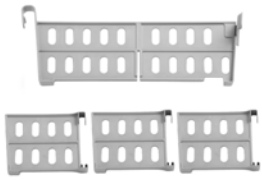

REF.	NOTES
0000SM00214U	

Plastic divider for drawer 10 L



REF.	NOTES
0000SM00227D	9 compartments
0000SM00228D	12 compartments

Pierced plastic sieve for mop soaking fitting drawers 10, 22 and 40 L

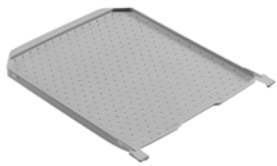

REF.	NOTES	PCK	VOLUME (m³)	GROSS WEIGHT (kg)
P1909925U		10	0,038	5,69

Ideal for a uniform distribution of the cleaning solution - For a quick pre-soaking (max 15 minutes)

Pierced plastic sieve with high border for mop soaking fitting drawers 10, 22 and 40 L

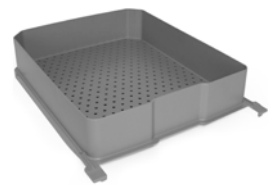

REF.	NOTES
P1909961U	

Ideal for a uniform distribution of the cleaning solution - For a quick pre-soaking (max 15 minutes)

Plastic cover for drawers 10, 22 and 40 L



REF.	NOTES	PCK	VOLUME (m³)	GROSS WEIGHT (kg)
P1909933U		10	0,038	7,21

MULTIPURPOSE TROLLEYS



ALPHA

MORGAN

CHROMED AND RILSAN COATED TROLLEYS

Pedal kit for Alpha trolleys with large, mini or supporting plate with 2 wheels and 150 L bag holder



REF.	NOTES
P2909915U	for base with wheels ø 100 mm
P2909918U	for base with rubber wheels ø 125 mm
P2909962U	for base with wheels ø 125 mm

Only for bases with 4 wheels

Pedal set for Alpha trolleys with short base and closed bag holder 150 L

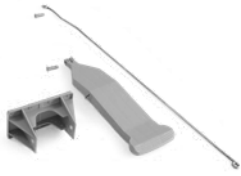

REF.	NOTES
P3909915U	for base with wheels ø 100 mm
P3909918U	for base with rubber wheels ø 125 mm
P3909962U	for base with wheels ø 125 mm

Only for bases with 4 wheels

Plastic cover for bag holder 120 L



REF.	NOTES
P291918A	
P291918B	



Please, require also no. 2 shock absorbing pistons art. P190908U for a perfect soft closing

Plastic cover for bag holder 120 L with check-list holder



REF.	NOTES
P291919A	
P291919B	
P291919T	



Please, require also no. 2 shock absorbing pistons art. P190908U for a perfect soft closing

Plastic cover for bag holder 120 L with storage room, check-list holder and lock



REF.	NOTES
P291920UA	
P291920UB	
P291920U	



Please, require also no. 2 shock absorbing pistons art. P190908U for a perfect soft closing

MULTIPURPOSE TROLLEYS

Multipurpose trolleys



ALPHA

MORGAN

CHROMED AND RILSAN COATED TROLLEYS

Plastic cover for bag holder 150 L with check-list holder



REF.	NOTES
P2909946A	
P2909946B	



Plastic cover for bag holder 150 L with check-list holder, storage room and removable locking key



REF.	NOTES
P2909955A	
P2909955B	



Please, require also no. 2 shock absorbing pistons art. P190908U for a perfect soft closing

Plastic cover for bag holder 150 L with check-list holder, storage room and removable double locking key



REF.	NOTES
P3909955A	
P3909955B	



Please, require also no. 2 shock absorbing pistons art. P190908U for a perfect soft closing

Plastic cover for central bag holder 150 L

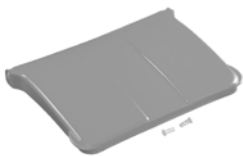

REF.	NOTES
P2919943U	



Please, require also no. 2 shock absorbing pistons art. P190908U for a perfect soft closing

Plastic cover for 70-litre bagholder complete with check-list holder



REF.	NOTES
P190916A	

Shock absorbing piston for a soft closing of the cover



REF.	NOTES
P190908U	



MULTIPURPOSE TROLLEYS



ALPHA

MORGAN

CHROMED AND RILSAN COATED TROLLEYS

Plastic bin 12 L with metal handle and cover with locking key



REF.	NOTES	SIZE (cm)
0000C02012U		21x26x36

Thanks to its locking key, it is possible to transport chemical and/or toxic products inside the bin safely

POCKET - foldable metal trolley for Top-Down® buckets 10 and 20 L



REF.	NOTES
V2030122	

Plastic mop holder fitting Alpha base



REF.	NOTES
P1909948U	

Tablet holder support for the Alpha vertical frame



REF.	NOTES
0000SM00401	

For tablet sizes 7 to 10.1 inches (20 to 31 cm)

PEG KIT - kit for attaching OneFred on Alpha trolleys complete with mop holder



REF.	NOTES
0000SM00298	

MULTIPURPOSE TROLLEYS



ALPHA

MORGAN

CHROMED AND RILSAN COATED TROLLEYS

PEG KIT - kit for attaching OneFred on Alpha trolleys

REF.	NOTES
000SM00301	



Lithium battery for Drive trolleys

REF.	NOTES
00BL1000	





ALPHA

MORGAN

CHROMED AND RILSAN COATED TROLLEYS

Collection and storage line

MORGAN 1000 - plastic trolley



MORGAN 2050 - plastic trolley



REF.	PCK	VOLUME (m³)	GROSS WEIGHT (kg)	SIZE (cm) ↓ ↓ ↓
0000MP1000A	1	0,191	15,46	96x61x109

0000SM00115U	FLIP - handle holder with rubber roll and snap closure fitting tubes Ø 22 mm	1 pc.
8218A	Blue plastic bucket 6 L with plastic handle	1 pc.
8218B	Red plastic bucket 6 L with plastic handle	1 pc.
P119002A	Blue side plastic basket for Morgan trolley	2 pcs
P202001A	Short plastic base with wheels ø 100 mm and bumpers for Morgan trolley	1 pc.
P816010U	Plastic bag holder 120 L with push-bar, bag-stretchers and reinforcements	1 pc.
R1030010	Rilsan coated vertical frame complete with screws for Morgan trolley	1 pc.

⚠ ACCESSORIES TO BE ORDERED SEPARATELY

3650A	Blue plastic-coated bag 73x97 cm, maximum capacity 120 L	1 pc.
P291920UA	Blue plastic cover for bag holder 120 L with storage room, check-list holder and lock	1 pc.

ON REQUEST, WITH SURCHARGE



REF.	PCK	VOLUME (m³)	GROSS WEIGHT (kg)	SIZE (cm) ↓ ↓ ↓
0000MP2050A	1	0,191	17,98	96x61x104

0000SM00115U	FLIP - handle holder with rubber roll and snap closure fitting tubes Ø 22 mm	1 pc.
P119001A	Blue small central plastic basket for Morgan trolley	2 pcs
P202001A	Short plastic base with wheels ø 100 mm and bumpers for Morgan trolley	1 pc.
P816010U	Plastic bag holder 120 L with push-bar, bag-stretchers and reinforcements	1 pc.
R1030010	Rilsan coated vertical frame complete with screws for Morgan trolley	2 pcs

⚠ ACCESSORIES TO BE ORDERED SEPARATELY

3650A	Blue plastic-coated bag 73x97 cm, maximum capacity 120 L	1 pc.
P291920UA	Blue plastic cover for bag holder 120 L with storage room, check-list holder and lock	1 pc.

ON REQUEST, WITH SURCHARGE





ALPHA

MORGAN

CHROMED AND RILSAN COATED TROLLEYS

Wet mopping line

MORGAN 3000 - plastic trolley



MORGAN 1040 - plastic trolley



REF.	PCK	VOLUME (m³)	GROSS WEIGHT (kg)	SIZE (cm) ↓ ↓ ↓
0000MP3000A	1	0,261	21,99	110x61x107

REF.	PCK	VOLUME (m³)	GROSS WEIGHT (kg)	SIZE (cm) ↓ ↓ ↓
0000MP1040A	1	0,261	20,75	129x67x113

0000SM00115U	FLIP - handle holder with rubber roll and snap closure fitting tubes Ø 22 mm	1 pc.
3048	Set of 3 stickers for buckets	1 pc.
8218A	Blue plastic bucket 6 L with plastic handle	1 pc.
8218B	Red plastic bucket 6 L with plastic handle	1 pc.
8218C	Yellow plastic bucket 6 L with plastic handle	1 pc.
8218F	Green plastic bucket 6 L with plastic handle	1 pc.
P119003A	Blue big central plastic basket with 6 hooks	2 pcs
P202050A	Long plastic base with 5 wheels ø 100 mm and bumpers for Morgan trolley	1 pc.
P816010U	Plastic bag holder 120 L with push-bar, bag-stretchers and reinforcements	1 pc.
R1030010	Rilsan coated vertical frame complete with screws for Morgan trolley	2 pcs

0000SM00115U	FLIP - handle holder with rubber roll and snap closure fitting tubes Ø 22 mm	1 pc.
7004A	REGULAR - blue plastic down-press wringer with plastic gears	1 pc.
8108A	Blue plastic bucket 15 L with plastic handle	1 pc.
8108B	Red plastic bucket 15 L with plastic handle	1 pc.
8218A	Blue plastic bucket 6 L with plastic handle	1 pc.
8218B	Red plastic bucket 6 L with plastic handle	1 pc.
P074000A	Blue supporting plastic plate fitting Morgan base	1 pc.
P119002A	Blue side plastic basket for Morgan trolley	2 pcs
P202001A	Short plastic base with wheels ø 100 mm and bumpers for Morgan trolley	1 pc.
P816010U	Plastic bag holder 120 L with push-bar, bag-stretchers and reinforcements	1 pc.
R1030010	Rilsan coated vertical frame complete with screws for Morgan trolley	1 pc.
R1040010	Rilsan coated wringer support complete with screws	1 pc.

⚠ ACCESSORIES TO BE ORDERED SEPARATELY

3650A	Blue plastic-coated bag 73x97 cm, maximum capacity 120 L	1 pc.
P291920UA	Blue plastic cover for bag holder 120 L with storage room, check-list holder and lock	1 pc.

⚠ ACCESSORIES TO BE ORDERED SEPARATELY

3650A	Blue plastic-coated bag 73x97 cm, maximum capacity 120 L	1 pc.
P291920UA	Blue plastic cover for bag holder 120 L with storage room, check-list holder and lock	1 pc.

ON REQUEST, WITH SURCHARGE



ON REQUEST, WITH SURCHARGE





ALPHA

MORGAN

CHROMED AND RILSAN COATED TROLLEYS

MORGAN 1050 - plastic trolley



MORGAN 1060 - plastic trolley



REF.	PCK	VOLUME (m³)	GROSS WEIGHT (kg)	SIZE (cm) ↓ ↓ ↓
0000MP1050A	1	0,261	19,37	96x67x113
0000SM00115U	FLIP - handle holder with rubber roll and snap closure fitting tubes Ø 22 mm			1 pc.
7004A	REGULAR - blue plastic down-press wringer with plastic gears			1 pc.
8108A	Blue plastic bucket 15 L with plastic handle			1 pc.
8108B	Red plastic bucket 15 L with plastic handle			1 pc.
8218A	Blue plastic bucket 6 L with plastic handle			1 pc.
8218B	Red plastic bucket 6 L with plastic handle			1 pc.
P119002A	Blue side plastic basket for Morgan trolley			1 pc.
P202001A	Short plastic base with wheels ø 100 mm and bumpers for Morgan trolley			1 pc.
P816010U	Plastic bag holder 120 L with push-bar, bag-stretchers and reinforcements			1 pc.
R1030125	Special shaped Rilsan coated vertical frame with two bars			1 pc.
R1040010	Rilsan coated wringer support complete with screws			1 pc.

REF.	PCK	VOLUME (m³)	GROSS WEIGHT (kg)	SIZE (cm) ↓ ↓ ↓
0000MP1060A	1	0,261	20,75	106x67x113
0000SM00115U	FLIP - handle holder with rubber roll and snap closure fitting tubes Ø 22 mm			1 pc.
7004A	REGULAR - blue plastic down-press wringer with plastic gears			1 pc.
8108A	Blue plastic bucket 15 L with plastic handle			1 pc.
8108B	Red plastic bucket 15 L with plastic handle			1 pc.
8218A	Blue plastic bucket 6 L with plastic handle			1 pc.
8218B	Red plastic bucket 6 L with plastic handle			1 pc.
P119002A	Blue side plastic basket for Morgan trolley			2 pcs
P202001A	Short plastic base with wheels ø 100 mm and bumpers for Morgan trolley			1 pc.
P816010U	Plastic bag holder 120 L with push-bar, bag-stretchers and reinforcements			1 pc.
R1030010	Rilsan coated vertical frame complete with screws for Morgan trolley			1 pc.
R1040010	Rilsan coated wringer support complete with screws			1 pc.

⚠ ACCESSORIES TO BE ORDERED SEPARATELY

3650A	Blue plastic-coated bag 73x97 cm, maximum capacity 120 L	1 pc.
P291920UA	Blue plastic cover for bag holder 120 L with storage room, check-list holder and lock	1 pc.

⚠ ACCESSORIES TO BE ORDERED SEPARATELY

3650A	Blue plastic-coated bag 73x97 cm, maximum capacity 120 L	1 pc.
P291920UA	Blue plastic cover for bag holder 120 L with storage room, check-list holder and lock	1 pc.

ON REQUEST, WITH SURCHARGE





ALPHA

MORGAN

CHROMED AND RILSAN COATED TROLLEYS

MORGAN 2010 - plastic trolley



MORGAN 2150 - plastic trolley



REF.	PCK	VOLUME (m³)	GROSS WEIGHT (kg)	SIZE (cm) ↓ ↓ ↓
0000MP2010A	1	0,261	23,84	129x67x113

0000SM00115U	FLIP - handle holder with rubber roll and snap closure fitting tubes Ø 22 mm	1 pc.
7004A	REGULAR - blue plastic down-press wringer with plastic gears	1 pc.
8108A	Blue plastic bucket 15 L with plastic handle	1 pc.
8108B	Red plastic bucket 15 L with plastic handle	1 pc.
8211/1A	Blue plastic bucket 12 L with plastic handle	1 pc.
8211/1B	Red plastic bucket 12 L with plastic handle	1 pc.
P074000A	Blue supporting plastic plate fitting Morgan base	1 pc.
P119001A	Blue small central plastic basket for Morgan trolley	2 pcs
P202001A	Short plastic base with wheels ø 100 mm and bumpers for Morgan trolley	1 pc.
P816010U	Plastic bag holder 120 L with push-bar, bag-stretchers and reinforcements	1 pc.
R1030010	Rilsan coated vertical frame complete with screws for Morgan trolley	2 pcs
R1040010	Rilsan coated wringer support complete with screws	1 pc.

⚠ ACCESSORIES TO BE ORDERED SEPARATELY

3650A	Blue plastic-coated bag 73x97 cm, maximum capacity 120 L	1 pc.
P291920UA	Blue plastic cover for bag holder 120 L with storage room, check-list holder and lock	1 pc.

ON REQUEST, WITH SURCHARGE



REF.	PCK	VOLUME (m³)	GROSS WEIGHT (kg)	SIZE (cm) ↓ ↓ ↓
0000MP2150A	1	0,261	19,25	96x61x113

Complete trolley sizes with OneFred 148 x65x113 cm

0000SM00115U	FLIP - handle holder with rubber roll and snap closure fitting tubes Ø 22 mm	1 pc.
8211/1A	Blue plastic bucket 12 L with plastic handle	1 pc.
8211/1B	Red plastic bucket 12 L with plastic handle	1 pc.
P119001A	Blue small central plastic basket for Morgan trolley	2 pcs
P202001A	Short plastic base with wheels ø 100 mm and bumpers for Morgan trolley	1 pc.
P816010U	Plastic bag holder 120 L with push-bar, bag-stretchers and reinforcements	1 pc.
R1030010	Rilsan coated vertical frame complete with screws for Morgan trolley	2 pcs

⚠ ACCESSORIES TO BE ORDERED SEPARATELY

0000LF0030YU	ONEFRED - 30 l plastic trolley with plastic handle	1 pc.
0000SM00297	PEG KIT - OneFred attachment kit for Morgan trolleys with broom holder	1 pc.
3650A	Blue plastic-coated bag 73x97 cm, maximum capacity 120 L	1 pc.
P291920UA	Blue plastic cover for bag holder 120 L with storage room, check-list holder and lock	1 pc.

ON REQUEST, WITH SURCHARGE





ALPHA

MORGAN

CHROMED AND RILSAN COATED TROLLEYS

MORGAN 3010 - plastic trolley



MORGAN 3060 - plastic trolley



REF.	PCK	VOLUME (m³)	GROSS WEIGHT (kg)	SIZE (cm) ↓ ↓ ↓
0000MP3010A	1	0,261	23,09	143x67x107

0000SM00115U	FLIP - handle holder with rubber roll and snap closure fitting tubes Ø 22 mm	1 pc.
3048	Set of 3 stickers for buckets	1 pc.
7004A	REGULAR - blue plastic down-press wringer with plastic gears	1 pc.
8108A	Blue plastic bucket 15 L with plastic handle	1 pc.
8108B	Red plastic bucket 15 L with plastic handle	1 pc.
8218A	Blue plastic bucket 6 L with plastic handle	1 pc.
8218B	Red plastic bucket 6 L with plastic handle	1 pc.
8218C	Yellow plastic bucket 6 L with plastic handle	1 pc.
8218F	Green plastic bucket 6 L with plastic handle	1 pc.
P074000A	Blue supporting plastic plate fitting Morgan base	1 pc.
P119003A	Blue big central plastic basket with 6 hooks	2 pcs
P202050A	Long plastic base with 5 wheels Ø 100 mm and bumpers for Morgan trolley	1 pc.
P816010U	Plastic bag holder 120 L with push-bar, bag-stretchers and reinforcements	1 pc.
R1030010	Rilsan coated vertical frame complete with screws for Morgan trolley	2 pcs
R1040010	Rilsan coated wringer support complete with screws	1 pc.

⚠ ACCESSORIES TO BE ORDERED SEPARATELY

3650A	Blue plastic-coated bag 73x97 cm, maximum capacity 120 L	1 pc.
P291920UA	Blue plastic cover for bag holder 120 L with storage room, check-list holder and lock	1 pc.

ON REQUEST, WITH SURCHARGE



REF.	PCK	VOLUME (m³)	GROSS WEIGHT (kg)	SIZE (cm) ↓ ↓ ↓
0000MP3060A	1	0,295	26,28	143x63x107

0000SM00113U	Handle holder with snap closure for tubes Ø 22 mm	2 pcs
0000SM00115U	FLIP - handle holder with rubber roll and snap closure fitting tubes Ø 22 mm	2 pcs
3048	Set of 3 stickers for buckets	1 pc.
3641A	Plastic basin 35 L	1 pc.
3642	Pierced plastic sieve for basin 35 L	1 pc.
8218A	Blue plastic bucket 6 L with plastic handle	1 pc.
8218B	Red plastic bucket 6 L with plastic handle	1 pc.
8218C	Yellow plastic bucket 6 L with plastic handle	1 pc.
8218F	Green plastic bucket 6 L with plastic handle	1 pc.
P074000A	Blue supporting plastic plate fitting Morgan base	1 pc.
P119003A	Blue big central plastic basket with 6 hooks	2 pcs
P202050A	Long plastic base with 5 wheels Ø 100 mm and bumpers for Morgan trolley	1 pc.
P516010U	Plastic bag holder 2x60 L with push-bar, bag-stretchers and reinforcements	1 pc.
R1030010	Rilsan coated vertical frame complete with screws for Morgan trolley	2 pcs

⚠ ACCESSORIES TO BE ORDERED SEPARATELY

0000AT0170A	Plastified bag 48x97 cm, capacity 60 L, blu	1 pc.
0000AT0170B	Plastified bag 48x97 cm, capacity 60 L, red	1 pc.
P291920UA	Blue plastic cover for bag holder 120 L with storage room, check-list holder and lock	1 pc.

ON REQUEST, WITH SURCHARGE



Multipurpose trolleys



ALPHA

MORGAN

CHROMED AND RILSAN COATED TROLLEYS

MORGAN 3080 - plastic trolley



REF.	PCK	VOLUME (m³)	GROSS WEIGHT (kg)	SIZE (cm) ↓ ↓ ↓
0000MP3080A	1	0,261	20,87	110x67x109
0000SM00115U	FLIP - handle holder with rubber roll and snap closure fitting tubes Ø 22 mm	1 pc.		
7004A	REGULAR - blue plastic down-press wringer with plastic gears	1 pc.		
8108A	Blue plastic bucket 15 L with plastic handle	1 pc.		
8108B	Red plastic bucket 15 L with plastic handle	1 pc.		
8218A	Blue plastic bucket 6 L with plastic handle	1 pc.		
8218B	Red plastic bucket 6 L with plastic handle	1 pc.		
P119002A	Blue side plastic basket for Morgan trolley	1 pc.		
P202050A	Long plastic base with 5 wheels ø 100 mm and bumpers for Morgan trolley	1 pc.		
P816010U	Plastic bag holder 120 L with push-bar, bag-stretchers and reinforcements	1 pc.		
R1030010	Rilsan coated vertical frame complete with screws for Morgan trolley	1 pc.		
R1040010	Rilsan coated wringer support complete with screws	1 pc.		

ACCESSORIES TO BE ORDERED SEPARATELY

0000PA0101C	Plastic board complete with fixing clamp ø 22 mm	1 pc.
3650A	Blue plastic-coated bag 73x97 cm, maximum capacity 120 L	1 pc.
P219007U	Plastic basket complete with 3 dividers fitting vertical frame Morgan trolley art. 0000MP3080A	1 pc.
P291920UA	Blue plastic cover for bag holder 120 L with storage room, check-list holder and lock	1 pc.

ON REQUEST, WITH SURCHARGE



MORGAN 4010 - plastic trolley



REF.	PCK	VOLUME (m³)	GROSS WEIGHT (kg)	SIZE (cm) ↓ ↓ ↓
0000MP4010A	1	0,298	29,69	143x67x107

0000SM00115U	FLIP - handle holder with rubber roll and snap closure fitting tubes Ø 22 mm	1 pc.
3048	Set of 3 stickers for buckets	1 pc.
7004A	REGULAR - blue plastic down-press wringer with plastic gears	1 pc.
8108A	Blue plastic bucket 15 L with plastic handle	1 pc.
8108B	Red plastic bucket 15 L with plastic handle	1 pc.
8218A	Blue plastic bucket 6 L with plastic handle	1 pc.
8218B	Red plastic bucket 6 L with plastic handle	1 pc.
8218C	Yellow plastic bucket 6 L with plastic handle	1 pc.
8218F	Green plastic bucket 6 L with plastic handle	1 pc.
P074000A	Blue supporting plastic plate fitting Morgan base	1 pc.
P119003A	Blue big central plastic basket with 6 hooks	2 pcs
P1220203E	Plastic cabinet with locking key for Morgan trolley	1 pc.
P202050A	Long plastic base with 5 wheels ø 100 mm and bumpers for Morgan trolley	1 pc.
P516010U	Plastic bag holder 2x60 L with push-bar, bag-stretchers and reinforcements	1 pc.
R1030137	Rilsan coated vertical frame for Morgan trolley art. 0000MP4010A	2 pcs
R1040010	Rilsan coated wringer support complete with screws	1 pc.

ACCESSORIES TO BE ORDERED SEPARATELY

0000AT0170A	Plastified bag 48x97 cm, capacity 60 L, blu	1 pc.
0000AT0170B	Plastified bag 48x97 cm, capacity 60 L, red	1 pc.
P291920UA	Blue plastic cover for bag holder 120 L with storage room, check-list holder and lock	1 pc.

ON REQUEST, WITH SURCHARGE



MULTIPURPOSE TROLLEYS



PRODUCT PARTIALLY MADE OF PLASTIC COMPONENTS CERTIFIED PSV - PLASTIC SECOND LIFE



ALPHA

MORGAN

CHROMED AND RILSAN COATED TROLLEYS

Top-Down® line

MORGAN TOP-DOWN® MIDI 8010 - plastic trolley



REF.	PCK	VOLUME (m³)	GROSS WEIGHT (kg)	SIZE (cm) ↓ ↓ ↓
0000MP8010A	1	0,461	24,62	116x62x116

0000SE1222B	Red plastic bucket 20 L with plastic handle	1 pc.
0000SE1322A	TOP-DOWN® - blue plastic bucket 20 L with plastic handle and hermetic cover	1 pc.
0000SE1322B	TOP-DOWN® - red plastic bucket 20 L with plastic handle and hermetic cover	1 pc.
0000SM00115U	FLIP - handle holder with rubber roll and snap closure fitting tubes Ø 22 mm	1 pc.
0000SM00121U	FLIP - handle holder with rubber roll fitting plastic baskets art. P1191100U and Morgan trolleys	2 pcs
8211/1A	Blue plastic bucket 12 L with plastic handle	1 pc.
8211/1B	Red plastic bucket 12 L with plastic handle	1 pc.
P119001A	Blue small central plastic basket for Morgan trolley	2 pcs
P202002A	Short plastic base with wheels ø 125 mm and bumpers for Morgan trolley	1 pc.
P716010U	Plastic bag holder 1x40 L + 1x80 L with push-bar, bag-stretchers and reinforcements	1 pc.
R1030103	Rilsan 5-bar vertical frame for Morgan Top-Down	2 pcs
R2030120	Rilsan 10- and 20-litre Top-Down bucket trolley, with 170mm ø wheels	1 pc.
R2200120	Rilsan coated support for buckets 10 L and 20 L for Morgan trolleys art. 0000MP8010A and 0000MP8020A	1 pc.

⚠ ACCESSORIES TO BE ORDERED SEPARATELY

0000AT0160A	Plastified bag 56x92 cm, capacity 80 L, blu	1 pc.
0000AT0170B	Plastified bag 48x97 cm, capacity 60 L, red	1 pc.
P291920UA	Blue plastic cover for bag holder 120 L with storage room, check-list holder and lock	1 pc.

MORGAN TOP-DOWN® MAXI 8020 - plastic trolley



REF.	PCK	VOLUME (m³)	GROSS WEIGHT (kg)	SIZE (cm) ↓ ↓ ↓
0000MP8020A	1	0,45	22,21	127x62x115

0000SE1310A	TOP-DOWN - blue plastic bucket 10 L with plastic handle and hermetic cover	1 pc.
0000SE1310B	TOP-DOWN - red plastic bucket 10 L with plastic handle and hermetic cover	1 pc.
0000SM00115U	FLIP - handle holder with rubber roll and snap closure fitting tubes Ø 22 mm	1 pc.
0000SM00121U	FLIP - handle holder with rubber roll fitting plastic baskets art. P1191100U and Morgan trolleys	2 pcs
3048	Set of 3 stickers for buckets	1 pc.
8218A	Blue plastic bucket 6 L with plastic handle	1 pc.
8218B	Red plastic bucket 6 L with plastic handle	1 pc.
8218C	Yellow plastic bucket 6 L with plastic handle	1 pc.
8218F	Green plastic bucket 6 L with plastic handle	1 pc.
8229U	Double fixing device with snap closure for laundry trolleys art. R9176, R9177, R9178 and R9179	1 pc.
P119003A	Blue big central plastic basket with 6 hooks	2 pcs
P1220203E	Plastic cabinet with locking key for Morgan trolley	1 pc.
P202053A	Long plastic base with 5 wheels ø 125 mm and bumpers for Morgan trolley	1 pc.
P716010U	Plastic bag holder 1x40 L + 1x80 L with push-bar, bag-stretchers and reinforcements	1 pc.
R1030137	Rilsan coated vertical frame for Morgan trolley art. 0000MP4010A	2 pcs
R2030133	Square Rilsan coated trolley with wheels ø 200 mm for Top-Down buckets 10L and 20L	1 pc.
R2200040	Rilsan coated bucket holder for buckets 10 and 20 L fitting Morgan vertical frame and Alpha trolley	1 pc.

⚠ ACCESSORIES TO BE ORDERED SEPARATELY

0000AT0160A	Plastified bag 56x92 cm, capacity 80 L, blu	1 pc.
0000AT0170B	Plastified bag 48x97 cm, capacity 60 L, red	1 pc.
P291920UA	Blue plastic cover for bag holder 120 L with storage room, check-list holder and lock	1 pc.



Multipurpose trolleys



ALPHA

MORGAN

CHROMED AND RILSAN COATED TROLLEYS

MORGAN TOP-DOWN® MIDI 7010 - plastic trolley



MORGAN TOP-DOWN® MAXI 7020 - plastic trolley



REF.	PCK	VOLUME (m³)	GROSS WEIGHT (kg)	SIZE (cm) ↓ ↓ ↓
0000MP7010A	1	0,295	26,74	115x61x116
0000SE1222B	Red plastic bucket 20 L with plastic handle			1 pc.
0000SE1322A	TOP-DOWN® - blue plastic bucket 20 L with plastic handle and hermetic cover			1 pc.
0000SE1322B	TOP-DOWN® - red plastic bucket 20 L with plastic handle and hermetic cover			1 pc.
0000SM00115U	FLIP - handle holder with rubber roll and snap closure fitting tubes Ø 22 mm			1 pc.
0000SM00121U	FLIP - handle holder with rubber roll fitting plastic baskets art. P1191100U and Morgan trolleys			2 pcs
8211/1A	Blue plastic bucket 12 L with plastic handle			1 pc.
8211/1B	Red plastic bucket 12 L with plastic handle			1 pc.
P064000A	Blue plastic supporting plate for bucket 10 and 20 L fitting Morgan base			1 pc.
P119001A	Blue small central plastic basket for Morgan trolley			2 pcs
P202002A	Short plastic base with wheels ø 125 mm and bumpers for Morgan trolley			1 pc.
P716010U	Plastic bag holder 1x40 L + 1x80 L with push-bar, bag-stretchers and reinforcements			1 pc.
R1030103	Rilsan 5-bar vertical frame for Morgan Top-Down			2 pcs
R2200040	Rilsan coated bucket holder for buckets 10 and 20 L fitting Morgan vertical frame and Alpha trolley			1 pc.

⚠ ACCESSORIES TO BE ORDERED SEPARATELY

0000AT0160A	Plastified bag 56x92 cm, capacity 80 L, blu	1 pc.
0000AT0170B	Plastified bag 48x97 cm, capacity 60 L, red	1 pc.
P291920UA	Blue plastic cover for bag holder 120 L with storage room, check-list holder and lock	1 pc.

REF.	PCK	VOLUME (m³)	GROSS WEIGHT (kg)	SIZE (cm) ↓ ↓ ↓
0000MP7020A	1	0,261	30,28	127x61x115
0000SE1222B	Red plastic bucket 20 L with plastic handle			1 pc.
0000SE1322A	TOP-DOWN® - blue plastic bucket 20 L with plastic handle and hermetic cover			1 pc.
0000SE1322B	TOP-DOWN® - red plastic bucket 20 L with plastic handle and hermetic cover			1 pc.
0000SM00115U	FLIP - handle holder with rubber roll and snap closure fitting tubes Ø 22 mm			1 pc.
0000SM00121U	FLIP - handle holder with rubber roll fitting plastic baskets art. P1191100U and Morgan trolleys			2 pcs
3048	Set of 3 stickers for buckets			1 pc.
8218A	Blue plastic bucket 6 L with plastic handle			1 pc.
8218B	Red plastic bucket 6 L with plastic handle			1 pc.
8218C	Yellow plastic bucket 6 L with plastic handle			1 pc.
8218F	Green plastic bucket 6 L with plastic handle			1 pc.
P064000A	Blue plastic supporting plate for bucket 10 and 20 L fitting Morgan base			1 pc.
P119003A	Blue big central plastic basket with 6 hooks			2 pcs
P202053A	Long plastic base with 5 wheels ø 125 mm and bumpers for Morgan trolley			1 pc.
P716010U	Plastic bag holder 1x40 L + 1x80 L with push-bar, bag-stretchers and reinforcements			1 pc.
R1030103	Rilsan 5-bar vertical frame for Morgan Top-Down			2 pcs
R2200040	Rilsan coated bucket holder for buckets 10 and 20 L fitting Morgan vertical frame and Alpha trolley			1 pc.

⚠ ACCESSORIES TO BE ORDERED SEPARATELY

0000AT0160A	Plastified bag 56x92 cm, capacity 80 L, blu	1 pc.
0000AT0170B	Plastified bag 48x97 cm, capacity 60 L, red	1 pc.
P291920UA	Blue plastic cover for bag holder 120 L with storage room, check-list holder and lock	1 pc.

MULTIPURPOSE TROLLEYS



PRODUCT PARTIALLY MADE OF PLASTIC COMPONENTS CERTIFIED PSV - PLASTIC SECOND LIFE



ALPHA

MORGAN

CHROMED AND RILSAN COATED TROLLEYS

Components for Morgan trolleys

Short plastic base for Morgan trolley



REF.	NOTES	SIZE (cm) ↓ ↓ ↓
P202001A	with wheels ø 100 mm	92x55
P202002A	with wheels ø 125 mm	92x55
P202017A	with rubber wheels ø 125 mm	92x55

Long plastic base complete with 5 wheels for Morgan trolley



REF.	NOTES	SIZE (cm) ↓ ↓ ↓
P202050A	with wheels ø 100 mm	105x55
P202053A	with wheels ø 125 mm	105x55
P202067A	with rubber wheels ø 125 mm	105x55

Plastic base complete with 5 wheels for Morgan Security trolley



REF.	NOTES	SIZE (cm) ↓ ↓ ↓
P402050U	with wheels ø 100 mm	105x55
P402053U	with wheels ø 125 mm	105x55
P402067U	with rubber wheels ø 125 mm	105x55

Rilsan coated vertical frame complete with screws for Morgan trolley



REF.	NOTES
R1030010	

Rilsan coated vertical frame with double connection for Morgan trolley art. 0000MP1030U



REF.	NOTES
R1030147	

Rilsan coated vertical frame for Morgan trolley art. 0000MP4010A



REF.	NOTES	SIZE (cm) ↓ ↓ ↓
R1030137		46x89



ALPHA

MORGAN

CHROMED AND RILSAN COATED TROLLEYS

Rilsan coated shaped vertical frame for Morgan trolley art. 0000MP1050A



REF.	NOTES
R1030125	

Rilsan 5-bar vertical frame for Morgan Top-Down®



REF.	NOTES
R1030103	

Rilsan coated vertical frame with 1 bar for Morgan Security trolley, 1 mt high



REF.	NOTES
R1030040	

Rilsan coated vertical frame with 3 bars for Morgan Security trolley, 1 mt high



REF.	NOTES
R1030134	where to fix the baskets art. P019004U

Small plastic basket for Morgan Security trolley



REF.	NOTES
P019004U	internal sizes 26x44x11 cm

Set of 2 plastic slots for sliding drawers complete with fixing clips for Morgan Security trolley



REF.	NOTES
P2909934E	





ALPHA

MORGAN

CHROMED AND RILSAN COATED TROLLEYS



Small central plastic basket for Morgan trolley



REF.	NOTES
P119001A	internal sizes 26,5x44x11 cm 
P119001U	internal sizes 26,5x44x11 cm 



Side plastic basket for Morgan trolley



REF.	NOTES
P119002A	internal sizes 18,5x49,5x11 cm 
P119002U	internal sizes 18,5x49,5x11 cm 

Big central plastic basket with 6 hooks



REF.	NOTES
P119003A	internal sizes 37,5x48,5x11 cm 
P119003U	internal sizes 37,5x48,5x11 cm 

Bag holder 120L without reinforcements, with push-bar, bag-stretchers, bag fixing hooks and 2 handle holders



REF.	NOTES
P906010U	

Plastic bag holder 120 L with push-bar, bag-stretchers and reinforcements



REF.	NOTES
P816010U	

Plastic bag holder 2x60 L with push-bar, bag-stretchers and reinforcements



REF.	NOTES
P516010U	

Plastic bag holder 1x40 L + 1x80 L with push-bar, bag-stretchers and reinforcements



REF.	NOTES
P716010U	



ALPHA

MORGAN

CHROMED AND RILSAN COATED TROLLEYS

Plastic bag stretcher for bag holder



REF.	NOTES
P190920U	for art. P816010U and P906010U
P190921U	for art. P516010U and P716010U

Rilsan coated bag holder 120 L with bag-stretcher for Morgan trolley



REF.	NOTES
R2060010	

Rilsan coated bag holder 2x70 L for Morgan trolley



REF.	NOTES
R3659	

Rilsan coated bucket holder for bucket fitting vertical frame Morgan trolley



REF.	NOTES
R1200020	for bucket 28 L

Rilsan coated bucket holder for buckets 10 and 20 L fitting vertical frame Morgan Security trolley



REF.	NOTES
R2200041	

Rilsan coated support for buckets 10 L and 20 L for Morgan trolleys art. 0000MP8010A and 0000MP8020A



REF.	NOTES
R2200120	

Rilsan coated wringer support complete with screws



REF.	NOTES
R1040010	



ALPHA

MORGAN

CHROMED AND RILSAN COATED TROLLEYS

Supporting plastic plate fitting Morgan base



REF.	NOTES
P074000A	
P074000U	

Available on request with 1 wheel

Supporting plastic plate for bucket 10 and 20 L fitting Morgan base



REF.	NOTES	SIZE (cm) ↓ ↓ ↓
P064000A		22x48x15
P064000U		22x48x15

Rilsan coated trolley for Top-Down® buckets 10 and 20 L, with wheels ø 170 mm



REF.	NOTES
R2030120	

Fitting Morgan trolleys art.no. 0000MP8010A and 0000MP8020A

Plastic cabinet with locking key for Morgan trolley art. 0000MP4010A



REF.	NOTES	SIZE (cm) ↓ ↓ ↓
P1220203E		49x39x34

Plastic basin 35 L



REF.	NOTES
3641A	

Pierced plastic sieve for basin 35 L



REF.	NOTES
3642	



ALPHA

MORGAN

CHROMED AND RILSAN COATED TROLLEYS

Accessories for Morgan trolleys

Divider for plastic bag holder 120 L



REF.	NOTES
P206020U	2x60 L
P206030U	1x40 L + 1x80 L
P206040U	3x40 L



Plastic divider with square shaped insert for bag holder 120 L



REF.	NOTES
P306020U	2x60 L and 20 L square shaped insert
P406020U	2x60 L and two 20 L square shaped inserts

For Alpha, Emotion range bag holders and bag holder code P906010U, Morgan range

Square plastic support 20 L for the divider of bag holder 120 L



REF.	NOTES
P1909957U	

For Alpha, Emotion range bag holders and bag holder code P906010U, Morgan range - Use recommended with net bags, code 0000AT0210

Chromed side basket



REF.	NOTES
3655	

Fitting Morgan trolleys with 2 hooks art.no. 0000SM00113U

POCKET - foldable metal trolley for Top-Down® buckets 10 and 20 L



REF.	NOTES
V2030122	



ALPHA

MORGAN

CHROMED AND RILSAN COATED TROLLEYS

Shock absorbing piston for a soft closing of the cover



REF.	NOTES
P190908U	



Plastic cover for bag holder 120 L



REF.	NOTES
P291918A	
P291918B	



Please, require also no. 2 shock absorbing pistons art. P190908U for a perfect soft closing

Plastic cover for bag holder 120 L with check-list holder



REF.	NOTES
P291919A	
P291919B	
P291919T	



Please, require also no. 2 shock absorbing pistons art. P190908U for a perfect soft closing

Plastic cover for bag holder 120 L with storage room, check-list holder and lock

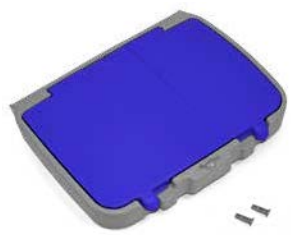

REF.	NOTES
P291920UA	
P291920UB	
P291920U	



Please, require also no. 2 shock absorbing pistons art. P190908U for a perfect soft closing

Plastic cover for bag holder 120 L art. 3657-R2060010- I2060010 and R2060060



REF.	NOTES
3639A	
3639B	

MULTIPURPOSE TROLLEYS

Multipurpose trolleys





ALPHA

MORGAN

CHROMED AND RILSAN COATED TROLLEYS

Plastic cover for bag holder 2x70L ref. 3637, 3659, I2060020 and R206005



REF.	NOTES
3644A	
3644B	

Rilsan coated broom/mop head holder support complete with fixing set



REF.	NOTES
R2050010	

Plastic broom/mop holder support for Morgan trolleys



REF.	NOTES
P119008U	

PEG KIT - kit for attaching OneFred on Morgan trolleys complete with mop holder



REF.	NOTES
0000SM00297	



PEG KIT - kit for attaching OneFred on Morgan trolleys



REF.	NOTES
0000SM00300	



Kit to fix Equodose on Morgan trolleys



REF.	NOTES
0000SM00613	

MULTIPURPOSE TROLLEYS



ALPHA

MORGAN

CHROMED AND RILSAN COATED TROLLEYS

Teddy trolleys

TEDDY 8080 - chromed trolley



TEDDY 8089 - chromed trolley



REF.	PCK	VOLUME (m³)	GROSS WEIGHT (kg)	SIZE (cm) ↓ ↓ ↓
8080X	1	0,191	12,48	82x51x105

0000SM00115U	FLIP - handle holder with rubber roll and snap closure fitting tubes Ø 22 mm	1 pc.
3657	Chromed bag holder 120 L for Teddy trolleys	1 pc.
8203/2	Chromed vertical frame for Teddy trolleys	1 pc.
8205/2	Chromed basket for Teddy and art. 8076 trolleys	1 pc.
8211/1A	Blue plastic bucket 12 L with plastic handle	1 pc.
8211/1B	Red plastic bucket 12 L with plastic handle	1 pc.
8234	Chromed bucket holder for Teddy trolleys	1 pc.
8611U	Plastic flanges with screws for vertical frame fixing	2 pcs
C8201CL	Chromed base 47x80 cm with wheels ø 100 mm and bumpers for trolleys art. 8080X and 8083X	1 pc.

⚠ ACCESSORIES TO BE ORDERED SEPARATELY

3639B	Red plastic cover for bag holder 120 L art. 3657-R2060010-I2060010 and R2060060	1 pc.
3650B	Red plastified bag 73x97,5 cm, capacity 120 L	1 pc.

REF.	PCK	VOLUME (m³)	GROSS WEIGHT (kg)	SIZE (cm) ↓ ↓ ↓
8089X	1	0,191	16,57	82x51x105

0000SM00115U	FLIP - handle holder with rubber roll and snap closure fitting tubes Ø 22 mm	1 pc.
3657	Chromed bag holder 120 L for Teddy trolleys	1 pc.
7004A	REGULAR - blue plastic down-press wringer with plastic gears	1 pc.
8203/2	Chromed vertical frame for Teddy trolleys	1 pc.
8205/2	Chromed basket for Teddy and art. 8076 trolleys	1 pc.
8211/1A	Blue plastic bucket 12 L with plastic handle	1 pc.
8211/1B	Red plastic bucket 12 L with plastic handle	1 pc.
8611U	Plastic flanges with screws for vertical frame fixing	4 pcs
C30075CL	Chromed base 47x80 cm with wheels ø 100 mm and bumpers for trolleys art. 8089X	1 pc.
C30277	Wringer support per Teddy cod. 8089X	1 pc.

⚠ ACCESSORIES TO BE ORDERED SEPARATELY

3639B	Red plastic cover for bag holder 120 L art. 3657-R2060010-I2060010 and R2060060	1 pc.
3650B	Red plastified bag 73x97,5 cm, capacity 120 L	1 pc.

Multipurpose trolleys



ALPHA

MORGAN

CHROMED AND RILSAN COATED TROLLEYS

TEDDY 8090 - chromed trolley



TEDDY 8098 - chromed trolley



REF.	PCK	VOLUME (m³)	GROSS WEIGHT (kg)	SIZE (cm) ↓ ↓ ↓
8090X	1	0,251	17,73	100x66x105

REF.	PCK	VOLUME (m³)	GROSS WEIGHT (kg)	SIZE (cm) ↓ ↓ ↓
8098X	1	0,261	30,23	134x66x110

0000SM00115U	FLIP - handle holder with rubber roll and snap closure fitting tubes Ø 22 mm	1 pc.
30141	Chromed wringer support for trolley art. 8098X	1 pc.
30300CL	Chromed base 47x100 cm with wheels ø 100 mm and bumpers for trolleys art. 8090X and 8098X	1 pc.
3657	Chromed bag holder 120 L for Teddy trolleys	1 pc.
60233U	Plastic anti-spill tray for bases art. C8201CL, 30300CL and C30139CL	1 pc.
7004A	REGULAR - blue plastic down-press wringer with plastic gears	1 pc.
8108A	Blue plastic bucket 15 L with plastic handle	1 pc.
8108B	Red plastic bucket 15 L with plastic handle	1 pc.
8203/2	Chromed vertical frame for Teddy trolleys	1 pc.
8205/2	Chromed basket for Teddy and art. 8076 trolleys	1 pc.
8611U	Plastic flanges with screws for vertical frame fixing	4 pcs

0000SM00115U	FLIP - handle holder with rubber roll and snap closure fitting tubes Ø 22 mm	1 pc.
30141	Chromed wringer support for trolley art. 8098X	1 pc.
30300CL	Chromed base 47x100 cm with wheels ø 100 mm and bumpers for trolleys art. 8090X and 8098X	1 pc.
30302	Central basket holder for trolley art. 9098X	2 pcs
30303	Bag support for Teddy art. 8098X	1 pc.
3048	Set of 3 stickers for buckets	1 pc.
3657	Chromed bag holder 120 L for Teddy trolleys	1 pc.
3671	Rod with nuts for Teddy trolleys	2 pcs
60233U	Plastic anti-spill tray for bases art. C8201CL, 30300CL and C30139CL	1 pc.
7004A	REGULAR - blue plastic down-press wringer with plastic gears	1 pc.
8108A	Blue plastic bucket 15 L with plastic handle	1 pc.
8108B	Red plastic bucket 15 L with plastic handle	1 pc.
8203/3	Chromed vertical frame for Teddy trolleys with rod	2 pcs
8218A	Blue plastic bucket 6 L with plastic handle	1 pc.
8218B	Red plastic bucket 6 L with plastic handle	1 pc.
8218C	Yellow plastic bucket 6 L with plastic handle	1 pc.
8218F	Green plastic bucket 6 L with plastic handle	1 pc.
8227	Plastic tray for the base of the trolleys art. 8049, Teddy 8090X-8098X and Panda	1 pc.
8253	Central plastic basket for Teddy and Jumbo Quadri trolleys	2 pcs
8611U	Plastic flanges with screws for vertical frame fixing	6 pcs

⚠ ACCESSORIES TO BE ORDERED SEPARATELY

3639B	Red plastic cover for bag holder 120 L art. 3657-R2060010-I2060010 and R2060060	1 pc.
3650B	Red plastified bag 73x97,5 cm, capacity 120 L	1 pc.
8227	Plastic tray for the base of the trolleys art. 8049, Teddy 8090X-8098X and Panda	1 pc.

⚠ ACCESSORIES TO BE ORDERED SEPARATELY

3639B	Red plastic cover for bag holder 120 L art. 3657-R2060010-I2060010 and R2060060	1 pc.
3650B	Red plastified bag 73x97,5 cm, capacity 120 L	1 pc.
60232	Transparent plastic cover for bucket 6 L	4 pcs

TEDDY R8090 - Rilsan coated trolley

REF.	PCK	VOLUME (m³)	GROSS WEIGHT (kg)	SIZE (cm) ↓ ↓ ↓
R8090	1	0,251	17,73	100x66x105

TEDDY R8098 - Rilsan coated trolley

REF.	PCK	VOLUME (m³)	GROSS WEIGHT (kg)	SIZE (cm) ↓ ↓ ↓
R8098	1	0,251	30,23	134x66x110

Available while stocks last

Available while stocks last

MULTIPURPOSE TROLLEYS



ALPHA

MORGAN

CHROMED AND RILSAN COATED TROLLEYS

TEDDY 8200 - chromed trolley



REF.	PCK	VOLUME (m³)	GROSS WEIGHT (kg)	SIZE (cm) ↓ ↓ ↓
8200X	1	0,359	22,27	82x72x105

000SM00115U	FLIP - handle holder with rubber roll and snap closure fitting tubes Ø 22 mm			1 pc.
3640	Side plastic basket			1 pc.
3657	Chromed bag holder 120 L for Teddy trolleys			1 pc.
7004A	REGULAR - blue plastic down-press wringer with plastic gears			1 pc.
8107A	Blue plastic bucket 25 L with plastic handle			1 pc.
8107B	Red plastic bucket 25 L with plastic handle			1 pc.
8211/1A	Blue plastic bucket 12 L with plastic handle			1 pc.
8211/1B	Red plastic bucket 12 L with plastic handle			1 pc.
8234	Chromed bucket holder for Teddy trolleys			1 pc.
8267	Basket holder for basket art. 3640			1 pc.
8611U	Plastic flanges with screws for vertical frame fixing			3 pcs
C30139CL	Chromed base 64x79 cm with wheels ø 100 mm and bumpers for trolley art. 8200X			1 pc.
C30140/2	Chromed vertical frame for trolley art. 8200X			1 pc.

⚠ ACCESSORIES TO BE ORDERED SEPARATELY

3639B	Red plastic cover for bag holder 120 L art. 3657-R2060010-12060010 and R2060060			1 pc.
3650B	Red plastified bag 73x97,5 cm, capacity 120 L			1 pc.
8227	Plastic tray for the base of the trolleys art. 8049, Teddy 8090X-8098X and Panda			1 pc.



ALPHA

MORGAN

CHROMED AND RILSAN COATED TROLLEYS

Components for Teddy trolleys

Chromed base with wheels ø 100 mm and bumpers for Teddy trolleys



REF.	NOTES
30300CL	for art. 8090X e 8098X
C30075CL	for art. 8089X
C30139CL	for art. 8200X
C8201CL	for art. 8080X and 8083X

Chromed vertical frame



REF.	NOTES
8203/2	

Chromed vertical frame for trolley art. 8200X



REF.	NOTES
C30140/2	

Chromed wringer support for trolley art. 8098X



REF.	NOTES
30141	

Chromed basket for Teddy and art. 8076 trolleys



REF.	NOTES	SIZE (cm) ↓ ↓ ↓
8205/2		50x20x13

Chromed bucket holder



REF.	NOTES
8234	

Basket holder for basket art. 3640



REF.	NOTES
8267	

MULTIPURPOSE TROLLEYS



ALPHA

MORGAN

CHROMED AND RILSAN COATED TROLLEYS

Side plastic basket



REF.	NOTES
3640	internal sizes 23x40x11 cm

Central basket holder for trolley art. 9098X



REF.	NOTES
30302	

Rod with nuts for Teddy trolleys



REF.	NOTES
3671	

Central plastic basket



REF.	NOTES
8252	for Jumbo Tank and Master - internal dimensions 63x45x7x cm
8253	for Teddy and Jumbo Quadri - internal dimensions 44x45x7 cm
3638	for Jumbo Quick and Mini Jumbo - internal dimensions 43,5x27,5x11 cm

Chromed bag holder 120 L for Teddy trolleys



REF.	NOTES
3657	

Chromed bag holder 2x70 L for Teddy trolleys



REF.	NOTES
3659	

Plastic tray for the base of the trolleys art. 8049, Teddy 8090X-8098X and Panda



REF.	NOTES	SIZE (cm) ↓ ↓ ↓
8227		39,5x59x2,5



ALPHA

MORGAN

CHROMED AND RILSAN COATED TROLLEYS

Plastic anti-spill tray for bases art. C8201CL, 30300CL and C30139CL

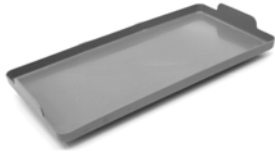

REF.	NOTES
60233U	

Plastic bag fixing clip



REF.	NOTES
8220A	

Plastic flanges with screws for vertical frame fixing



REF.	NOTES
8611U	

Accessories for Teddy trolleys



Plastic cover for bag holder 120 L art. 3657-R2060010- I2060010 and R2060060



REF.	NOTES
3639A	
3639B	

Plastic cover for bag holder 2x70L ref. 3637, 3659, I2060020 and R206005



REF.	NOTES
3644A	
3644B	

Chromed broom/mop holder



REF.	NOTES
8213	

Fixing clips for broom/mop holder support (2 pcs)



REF.	NOTES
8225U	



ALPHA

MORGAN

CHROMED AND RILSAN COATED TROLLEYS

Jumbo trolleys

JUMBO TANK 3054 - chromed trolley



JUMBO MASTER 3064 - chromed trolley



REF.	PCK	VOLUME (m³)	GROSS WEIGHT (kg)	SIZE (cm) ↓ ↓ ↓
3054	1	0,291	34,62	142x58x110

REF.	PCK	VOLUME (m³)	GROSS WEIGHT (kg)	SIZE (cm) ↓ ↓ ↓
3064	1	0,291	29,42	113x67x110

0000SM00115U	FLIP - handle holder with rubber roll and snap closure fitting tubes Ø 22 mm	1 pc.
30006	Chromed fixing kit for basin art. 3641A	2 pcs
3048	Set of 3 stickers for buckets	1 pc.
3604	Chromed vertical frame for Jumbo trolley	2 pcs
3611	Tray holder for art. 8252 with handle holder for Jumbo Tank trolley	1 pc.
3615	Chromed holder for plastic basket art. 8252 for Jumbo Master trolley	1 pc.
3633	Chromed bag support for Jumbo trolley	1 pc.
3637	Chromed bag holder 2x70 L for Jumbo trolleys and Panda art. 7221	1 pc.
3641A	Plastic basin 35 L	1 pc.
3642	Pierced plastic sieve for basin 35 L	1 pc.
3665	Chromed bucket holder for tray art. 8252	1 pc.
8218A	Blue plastic bucket 6 L with plastic handle	1 pc.
8218B	Red plastic bucket 6 L with plastic handle	1 pc.
8218C	Yellow plastic bucket 6 L with plastic handle	1 pc.
8218F	Green plastic bucket 6 L with plastic handle	1 pc.
8252	Central plastic basket for Jumbo Tank and Master trolleys	2 pcs
C3629CL	Chromed base 77x51 cm with wheels ø 100 mm and bumpers for Jumbo Tank, Master and Quick trolleys	1 pc.

0000SM00115U	FLIP - handle holder with rubber roll and snap closure fitting tubes Ø 22 mm	1 pc.
3604	Chromed vertical frame for Jumbo trolley	2 pcs
3606	Chromed bag holder 120 L for Jumbo trolley	1 pc.
3613	Chromed basket for Jumbo Master trolley	2 pcs
3613/1	Chromed basket with long hooking system for Jumbo Master trolleys	1 pc.
3614	Chromed rod for basket art. 3613 for Jumbo Master trolley	3 pcs
3626	Chromed holder for plastic basket fitting the base of the Jumbo trolley art. 3064	1 pc.
3628	Chromed wringer support for Jumbo Master trolley	1 pc.
3633	Chromed bag support for Jumbo trolley	1 pc.
7004A	REGULAR - blue plastic down-press wringer with plastic gears	1 pc.
8108A	Blue plastic bucket 15 L with plastic handle	1 pc.
8108B	Red plastic bucket 15 L with plastic handle	1 pc.
8211/1A	Blue plastic bucket 12 L with plastic handle	1 pc.
8211/1B	Red plastic bucket 12 L with plastic handle	1 pc.
8252	Central plastic basket for Jumbo Tank and Master trolleys	1 pc.
C3629CL	Chromed base 77x51 cm with wheels ø 100 mm and bumpers for Jumbo Tank, Master and Quick trolleys	1 pc.

⚠ ACCESSORIES TO BE ORDERED SEPARATELY

0000AT0160A	Plastified bag 56x92 cm, capacity 80 L, blu	1 pc.
0000AT0160B	Plastified bag 56x92 cm, capacity 80 L, red	1 pc.
3644A	Plastic cover for bag holder 2x70L ref. 3637, 3659, I2060020 and R206005, blue	1 pc.
3644B	Plastic cover for bag holder 2x70L ref. 3637, 3659, I2060020 and R206005, red	1 pc.
60232	Transparent plastic cover for bucket 6 L	1 pc.

⚠ ACCESSORIES TO BE ORDERED SEPARATELY

3639B	Red plastic cover for bag holder 120 L art. 3657-R2060010-I2060010 and R2060060	1 pc.
3650B	Red plastified bag 73x97,5 cm, capacity 120 L	1 pc.

Multipurpose trolleys



ALPHA

MORGAN

CHROMED AND RILSAN COATED TROLLEYS

JUMBO MASTER 3072 - chromed trolley



JUMBO QUADRI 3080 - chromed trolley



REF.	PCK	VOLUME (m³)	GROSS WEIGHT (kg)	SIZE (cm) ↓ ↓ ↓
3072	1	0,291	20,62	84x58x110
0000SM00115U	FLIP - handle holder with rubber roll and snap closure fitting tubes Ø 22 mm			1 pc.
3604	Chromed vertical frame for Jumbo trolley			2 pcs
3615	Chromed holder for plastic basket art. 8252 for Jumbo Master trolley			2 pcs
8252	Central plastic basket for Jumbo Tank and Master trolleys			3 pcs
C3629CL	Chromed base 77x51 cm with wheels ø 100 mm and bumpers for Jumbo Tank, Master and Quick trolleys			1 pc.

REF.	PCK	VOLUME (m³)	GROSS WEIGHT (kg)	SIZE (cm) ↓ ↓ ↓
3080	1	0,291	22,62	122x58x110
3604	Chromed vertical frame for Jumbo trolley			2 pcs
3606	Chromed bag holder 120 L for Jumbo trolley			1 pc.
3607	Chromed basket holder for Jumbo Quadri trolley			2 pcs
3633	Chromed bag support for Jumbo trolley			1 pc.
3640	Side plastic basket			1 pc.
7166	Holder for plastic basket art. 3640			1 pc.
8218A	Blue plastic bucket 6 L with plastic handle			1 pc.
8218B	Red plastic bucket 6 L with plastic handle			1 pc.
8253	Central plastic basket for Teddy and Jumbo Quadri trolleys			3 pcs
C3605CL	Chromed base 51x51 cm with wheels ø 100 mm and bumpers for Jumbo Quadri trolley			1 pc.

⚠ ACCESSORIES TO BE ORDERED SEPARATELY

3639B	Red plastic cover for bag holder 120 L art. 3657-R2060010-12060010 and R2060060			1 pc.
3650B	Red plastified bag 73x97,5 cm, capacity 120 L			1 pc.
60232	Transparent plastic cover for bucket 6 L			2 pcs

MULTIPURPOSE TROLLEYS



ALPHA

MORGAN

CHROMED AND RILSAN COATED TROLLEYS

JUMBO QUADRI 3082 - chromed trolley



JUMBO QUICK 3090 - chromed trolley



REF.	PCK	VOLUME (m³)	GROSS WEIGHT (kg)	SIZE (cm) ↓ ↓ ↓
3082	1	0,291	17,62	136x58x110

3604	Chromed vertical frame for Jumbo trolley	2 pcs
3606	Chromed bag holder 120 L for Jumbo trolley	2 pcs
3607	Chromed basket holder for Jumbo Quadri trolley	2 pcs
3633	Chromed bag support for Jumbo trolley	1 pc.
8253	Central plastic basket for Teddy and Jumbo Quadri trolleys	3 pcs
C3605CL	Chromed base 51x51 cm with wheels ø 100 mm and bumpers for Jumbo Quadri trolley	1 pc.

⚠ ACCESSORIES TO BE ORDERED SEPARATELY

3639A	Blue plastic cover for bag holder 120 L art. 3657-R2060010-I2060010 and R2060060	1 pc.
3639B	Red plastic cover for bag holder 120 L art. 3657-R2060010-I2060010 and R2060060	1 pc.
3650A	Blue plastic-coated bag 73x97 cm, maximum capacity 120 L	1 pc.
3650B	Red plastified bag 73x97,5 cm, capacity 120 L	1 pc.

Available while stocks last

REF.	PCK	VOLUME (m³)	GROSS WEIGHT (kg)	SIZE (cm) ↓ ↓ ↓
3090	1	0,291	19,36	120x66x110

3600	Chromed wringer support for Jumbo trolley	1 pc.
3604	Chromed vertical frame for Jumbo trolley	2 pcs
3606	Chromed bag holder 120 L for Jumbo trolley	1 pc.
3624	Chromed holder for plastic basket art. 3638 for Jumbo Quick trolley	2 pcs
3633	Chromed bag support for Jumbo trolley	1 pc.
3638	Central plastic basket for Jumbo Quick and Mini Jumbo trolleys	3 pcs
60234	Plastic anti-spill tray for Jumbo trolley	1 pc.
7004A	REGULAR - blue plastic down-press wringer with plastic gears	1 pc.
8108A	Blue plastic bucket 15 L with plastic handle	1 pc.
8108B	Red plastic bucket 15 L with plastic handle	1 pc.
C3629CL	Chromed base 77x51 cm with wheels ø 100 mm and bumpers for Jumbo Tank, Master and Quick trolleys	1 pc.

⚠ ACCESSORIES TO BE ORDERED SEPARATELY

3639B	Red plastic cover for bag holder 120 L art. 3657-R2060010-I2060010 and R2060060	1 pc.
3650B	Red plastified bag 73x97,5 cm, capacity 120 L	1 pc.

JUMBO QUICK R3090 - Rilsan coated trolley

REF.	PCK	VOLUME (m³)	GROSS WEIGHT (kg)	SIZE (cm) ↓ ↓ ↓
R3090	1	0,291	31,71	120x66x110

Available while stocks last



ALPHA

MORGAN

CHROMED AND RILSAN COATED TROLLEYS

MINI JUMBO 3010 - chromed trolley



REF.	PCK	VOLUME (m³)	GROSS WEIGHT (kg)	SIZE (cm) ↓ ↓ ↓
3010	1	0,291	16,62	64x57x110

0000SM00115U	FLIP - handle holder with rubber roll and snap closure fitting tubes Ø 22 mm	1 pc.
13633	Bag support with wheel Ø 80 mm for Jumbo trolley	1 pc.
3604	Chromed vertical frame for Jumbo trolley	2 pcs
3606	Chromed bag holder 120 L for Jumbo trolley	1 pc.
3624	Chromed holder for plastic basket art. 3638 for Jumbo Quick trolley	2 pcs
3638	Central plastic basket for Jumbo Quick and Mini Jumbo trolleys	3 pcs
3663CL	Chromed base 39x50 cm with wheels ø 100 mm and bumpers for Mini Jumbo trolleys	1 pc.

⚠ ACCESSORIES TO BE ORDERED SEPARATELY

3639B	Red plastic cover for bag holder 120 L art. 3657-R2060010-12060010 and R2060060	1 pc.
3650B	Red plastified bag 73x97,5 cm, capacity 120 L	1 pc.



ALPHA

MORGAN

CHROMED AND RILSAN COATED TROLLEYS

Smart trolleys

SMART 7230 - chromed trolley



REF.	PCK	VOLUME (m³)	GROSS WEIGHT (kg)	SIZE (cm) ↓ ↓ ↓
7230	1	0,23	20,02	85x66x115

0000SM00115U	FLIP - handle holder with rubber roll and snap closure fitting tubes Ø 22 mm	1 pc.
30601	Vertical frame for Smart trolleys	1 pc.
30606	Chromed bag holder 120 L for Smart trolleys	1 pc.
60233U	Plastic anti-spill tray for bases art. C8201CL, 30300CL and C30139CL	1 pc.
7004A	REGULAR - blue plastic down-press wringer with plastic gears	1 pc.
8108A	Blue plastic bucket 15 L with plastic handle	1 pc.
8108B	Red plastic bucket 15 L with plastic handle	1 pc.
8218A	Blue plastic bucket 6 L with plastic handle	1 pc.
8218B	Red plastic bucket 6 L with plastic handle	1 pc.
8611U	Plastic flanges with screws for vertical frame fixing	1 pc.
C30600CL	Chromed base with wheels ø 100 mm and bumpers for Smart trolleys	1 pc.
C30602CL	Chromed wringer support for Smart trolleys	1 pc.
C30605	Chromed bag support for Smart trolleys	1 pc.
C30610	Chromed basket for Smart trolley art. 7230	1 pc.

⚠ ACCESSORIES TO BE ORDERED SEPARATELY

3650B	Red plastified bag 73x97,5 cm, capacity 120 L	1 pc.
60232	Transparent plastic cover for bucket 6 L	2 pcs

SMART R7230 - Rilsan coated trolley

REF.	PCK	VOLUME (m³)	GROSS WEIGHT (kg)	SIZE (cm) ↓ ↓ ↓
R7230	1	0,23	22,02	85x66x115

Available while stocks last

SMART 7235 - chromed trolley



REF.	PCK	VOLUME (m³)	GROSS WEIGHT (kg)	SIZE (cm) ↓ ↓ ↓
7235	1	0,23	12,48	85x53x105

0000SM00115U	FLIP - handle holder with rubber roll and snap closure fitting tubes Ø 22 mm	1 pc.
30601	Vertical frame for Smart trolleys	1 pc.
3640	Side plastic basket	1 pc.
3657	Chromed bag holder 120 L for Teddy trolleys	1 pc.
8218A	Blue plastic bucket 6 L with plastic handle	1 pc.
8218B	Red plastic bucket 6 L with plastic handle	1 pc.
8227	Plastic tray for the base of the trolleys art. 8049, Teddy 8090X-8098X and Panda	1 pc.
C30600CL	Chromed base with wheels ø 100 mm and bumpers for Smart trolleys	1 pc.
C30604	Chromed basket for Smart trolley art. 7235	2 pcs

⚠ ACCESSORIES TO BE ORDERED SEPARATELY

3639B	Red plastic cover for bag holder 120 L art. 3657-R2060010-I2060010 and R2060060	1 pc.
3650B	Red plastified bag 73x97,5 cm, capacity 120 L	1 pc.
60232	Transparent plastic cover for bucket 6 L	2 pcs

SMART R7235 - Rilsan coated trolley

REF.	PCK	VOLUME (m³)	GROSS WEIGHT (kg)	SIZE (cm) ↓ ↓ ↓
R7235	1	0,23	14,93	85x53x105

Available while stocks last



ALPHA

MORGAN

CHROMED AND RILSAN COATED TROLLEYS

Components for Jumbo trolleys - Ecology

Chromed base with wheels ø 100 mm and bumpers for Jumbo trolley



REF.	NOTES	SIZE (cm) ↓ ↓ ↓
C3629CL	for Jumbo Tank, Master and Quick	77x51
C3605CL	for Jumbo Quadri	51x51
3663CL	for Mini Jumbo	39x50

Chromed vertical frame for Jumbo trolley



REF.	NOTES
3604	

Chromed bag support for Jumbo trolley



REF.	NOTES
3633	

Chromed bag holder 120 L for Jumbo trolley



REF.	NOTES
3606	

2x70 lt chromed bag holder for Jumbo trolleys



REF.	NOTES
3637	

Chromed basket holder for Jumbo trolley



REF.	NOTES
3615	for basket art. 8252
3624	for basket art. 3638
3607	for basket art. 8253

Tray holder for art. 8252 with handle holder for Jumbo Tank trolley



REF.	NOTES
3611	



ALPHA

MORGAN

CHROMED AND RILSAN COATED TROLLEYS

Side plastic basket



REF.	NOTES
3640	internal sizes 23x40x11 cm

Central plastic basket



REF.	NOTES
8252	for Jumbo Tank and Master - internal dimensions 63x45x7 cm
8253	for Teddy and Jumbo Quadri - internal dimensions 44x45x7 cm
3638	for Jumbo Quick and Mini Jumbo - internal dimensions 43,5x27,5x11 cm

Chromed basket for Jumbo trolley

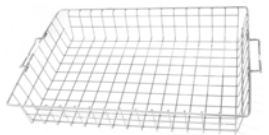

REF.	NOTES	SIZE (cm) ↓ ↓ ↓
3601	for Jumbo Quadri	45x45x11
3610	for Jumbo Master	65x48x11

Chromed basket for Jumbo Master trolley



REF.	NOTES	SIZE (cm) ↓ ↓ ↓
3613		66x23x11

Chromed rod for basket art. 3613 for Jumbo Master trolley



REF.	NOTES
3614	

Chromed wringer support for Jumbo trolley



REF.	NOTES
3600	

Chromed holder for plastic basket fitting the base of the Jumbo trolley art. 3064



REF.	NOTES
3626	



ALPHA

MORGAN

CHROMED AND RILSAN COATED TROLLEYS

Chromed basket holder for Ecology trolleys



REF.	NOTES
3647	

Chromed bucket holder for tray art. 8252



REF.	NOTES
3665	

Plastic anti-spill tray for Jumbo trolley



REF.	NOTES
60234	

Plastic flanges with screws for vertical frame fixing



REF.	NOTES
8611U	

PICK-UP - plastic bin 45 L without wheels, complete with cover and screen printed plastic plate



REF.	NOTES	SIZE (cm)
		↓ ↓ ↓
3667A	with image "paper"	51x31,5x30
3667B	with image "metal"	51x31,5x30
3667C	with image "plastic"	51x31,5x30
3667E	with image "non-recyclable waste"	51x31,5x30
3667F	with image "glass"	51x31,5x30
3667G	with image "organic waste"	51x31,5x30

Plastic basin 35 L



REF.	NOTES
3641A	

Pierced plastic sieve for basin 35 L



REF.	NOTES
3642	



ALPHA

MORGAN

CHROMED AND RILSAN COATED TROLLEYS

Set with allen spanner, screws and nuts for Jumbo assembling





REF.	NOTES
8615	

Accessories for Jumbo and Ecology trolleys



Plastic cover for bag holder 120 L art. 3657-R2060010- I2060010 and R2060060



REF.	NOTES
3639A	
3639B	

Plastic cover for bag holder 2x70L ref. 3637, 3659, I2060020 and R206005



REF.	NOTES
3644A	
3644B	

Chromed broom/mop holder



REF.	NOTES
8213	

Fixing clips for broom/mop holder support (2 pcs)



REF.	NOTES
8225U	



ALPHA

MORGAN

CHROMED AND RILSAN COATED TROLLEYS

Panda trolleys

PANDA 7106 - chromed trolley



PANDA 7108 - chromed trolley



REF.	PCK	VOLUME (m³)	GROSS WEIGHT (kg)	SIZE (cm) ↓ ↓ ↓
7106	1	0,191	14,35	75x46x122
0000SM00115U	FLIP - handle holder with rubber roll and snap closure fitting tubes Ø 22 mm			1 pc.
3640	Side plastic basket			1 pc.
7004A	REGULAR - blue plastic down-press wringer with plastic gears			1 pc.
7151	Basket holder for Panda trolleys art. 7106, 7108 and 7200			1 pc.
7152	Bag holder 120 L for Panda trolleys art. 7106 and 7200			1 pc.
7153	Chromed bag support for Panda trolley art. 7106			1 pc.
7155	Push-bar for Panda trolleys art. 7106 and 7108			1 pc.
7159	Chromed basket for bottles fitting Panda trolleys art. 7106, 7108 and 7200			1 pc.
7161CL	Chromed base with 2 wheels ø 80 mm and with 2 wheels ø 185 mm for Panda trolleys art. 7106 and 7108			1 pc.
8108B	Red plastic bucket 15 L with plastic handle			1 pc.
8218A	Blue plastic bucket 6 L with plastic handle			1 pc.
8218B	Red plastic bucket 6 L with plastic handle			1 pc.
8611U	Plastic flanges with screws for vertical frame fixing			2 pcs

REF.	PCK	VOLUME (m³)	GROSS WEIGHT (kg)	SIZE (cm) ↓ ↓ ↓
7108	1	0,191	18,57	66x46x122
0000SM00115U	FLIP - handle holder with rubber roll and snap closure fitting tubes Ø 22 mm			1 pc.
3640	Side plastic basket			2 pcs
7004A	REGULAR - blue plastic down-press wringer with plastic gears			1 pc.
7151	Basket holder for Panda trolleys art. 7106, 7108 and 7200			1 pc.
7154	Basket holder for Panda trolley art. 7108			1 pc.
7155	Push-bar for Panda trolleys art. 7106 and 7108			1 pc.
7159	Chromed basket for bottles fitting Panda trolleys art. 7106, 7108 and 7200			1 pc.
7161CL	Chromed base with 2 wheels ø 80 mm and with 2 wheels ø 185 mm for Panda trolleys art. 7106 and 7108			1 pc.
8108B	Red plastic bucket 15 L with plastic handle			1 pc.
8218A	Blue plastic bucket 6 L with plastic handle			1 pc.
8218B	Red plastic bucket 6 L with plastic handle			1 pc.
8611U	Plastic flanges with screws for vertical frame fixing			2 pcs

⚠ ACCESSORIES TO BE ORDERED SEPARATELY

3650B	Red plastified bag 73x97,5 cm, capacity 120 L	1 pc.
-------	---	-------

⚠ ACCESSORIES TO BE ORDERED SEPARATELY

60232	Transparent plastic cover for bucket 6 L	2 pcs
-------	--	-------



ALPHA

MORGAN

CHROMED AND RILSAN COATED TROLLEYS

PANDA 7200 - chromed trolley



REF.	PCK	VOLUME (m³)	GROSS WEIGHT (kg)	SIZE (cm) ↓ ↓ ↓
7200	1	0,23	17,6	75x65x122

3640	Side plastic basket	1 pc.
7004A	REGULAR - blue plastic down-press wringer with plastic gears	1 pc.
7151	Basket holder for Panda trolleys art. 7106, 7108 and 7200	1 pc.
7152	Bag holder 120 L for Panda trolleys art. 7106 and 7200	1 pc.
7156	Chromed push-bar for Panda trolley art. 7200	1 pc.
7157CL	Chromed base with wheels ø 80 mm, 2 with brakes and bumpers, for Panda trolley art. 7200	1 pc.
7159	Chromed basket for bottles fitting Panda trolleys art. 7106, 7108 and 7200	1 pc.
7160CL	Chromed bag support with wheel ø 80 mm for Panda trolley art. 7200	1 pc.
7163	Chromed wringer support for Panda trolleys art. 7200	1 pc.
8108A	Blue plastic bucket 15 L with plastic handle	1 pc.
8108B	Red plastic bucket 15 L with plastic handle	1 pc.
8218A	Blue plastic bucket 6 L with plastic handle	1 pc.
8218B	Red plastic bucket 6 L with plastic handle	1 pc.
8223U	Handle holder complete with screws for tubes ø 14 mm	1 pc.
8611U	Plastic flanges with screws for vertical frame fixing	1 pc.

⚠ ACCESSORIES TO BE ORDERED SEPARATELY

3650B	Red plastified bag 73x97,5 cm, capacity 120 L	1 pc.
60232	Transparent plastic cover for bucket 6 L	2 pcs



ALPHA

MORGAN

CHROMED AND RILSAN COATED TROLLEYS

Components for Panda trolleys

Chromed base with 2 wheels \varnothing 80 mm and 2 wheels \varnothing 175 mm for Panda trolley art. 7106 and 7108



REF.	NOTES
7161CL	

Push-bar for Panda trolleys art. 7106 and 7108



REF.	NOTES
7155	

Bag holder 120 L for Panda trolleys art. 7106 and 7200



REF.	NOTES
7152	

Basket holder for Panda trolleys art. 7106, 7108 and 7200



REF.	NOTES
7151	

Basket holder for Panda trolley art. 7108



REF.	NOTES
7154	

Chromed basket for bottles fitting Panda trolleys art. 7106, 7108 and 7200



REF.	NOTES
7159	

Chromed bag support for Panda trolley art. 7106



REF.	NOTES
7153	



ALPHA

MORGAN

CHROMED AND RILSAN COATED TROLLEYS

Chromed base with wheels \varnothing 80 mm, 2 with brakes and bumpers, for Panda trolley art. 7200



REF.	NOTES
7157CL	

Chromed push-bar for Panda trolley art. 7200



REF.	NOTES
7156	

Chromed bag support with wheel \varnothing 80 mm for Panda trolley art. 7200



REF.	NOTES
7160CL	

Chromed wringer support for Panda trolleys art. 7200



REF.	NOTES
7163	

Holder for plastic basket art. 3640



REF.	NOTES
7166	

Side plastic basket



REF.	NOTES
3640	internal sizes 23x40x11 cm

Plastic tray for the base of the trolleys art. 8049, Teddy 8090X-8098X and Panda



REF.	NOTES	SIZE (cm)
8227		 39,5x59x2,5



ALPHA

MORGAN

CHROMED AND RILSAN COATED TROLLEYS

Plastic flanges with screws for vertical frame fixing



REF.	NOTES
8611U	

Plastic bag fixing clip



REF.	NOTES
8220A	

Accessories for Panda trolleys

Chromed broom/mop holder



REF.	NOTES
8213	

Fixing clips for broom/mop holder support (2 pcs)



REF.	NOTES
8225U	



A-B PLUS anti-bacterial system



A-B PLUS



A-B PLUS



100% recyclable



A-B Plus is a complete cleaning system whose components have been treated with anti-bacterial additives in order to slow down the growth of bacteria, molds and fungi. This cleaning system uses silver ion technology for microfiber and Zinc Pyrithione for Alpha trolleys and their components. The anti-bacterial additive, mixed during the production process, is part of the polymeric matrice and penetrates the cell wall of the micro-organism blocking its growth and reproduction functions. The anti-bacterial treatment can be **guaranteed for the whole life cycle** of the product.

Better hygiene and safety for everyone

- For end users: patients, children, old people, consumers
- For professional people: doctors, nurses, teachers and food operators
- For cleaning operators
- For environment

A sanitization cleaning system for hospitals... and more than that

- Hospitals: both low-risk common areas and high-risk areas, such as operating theatres, infection disease wards, intensive care wards and similar environments
- Nursing homes
- Public facilities: schools, nursery schools, food industries, banks, airports, railway stations



Tested by EcamRicert S.r.l. - Company subject to the direction and coordination of Mérieux NutriSciences Corporation - Viale del Lavoro, 6 36030 Monte di Malo (VI) Italy, according to ISO 22196-2011



Tested by SGS, according to ISO 20743-2013

A-B PLUS

Alpha A-B PLUS trolleys

ALPHA A-B PLUS 0503700 - plastic anti-bacterial trolley



ALPHA A-B PLUS 0603700 - plastic anti-bacterial trolley



REF.	PCK	VOLUME (m³)	GROSS WEIGHT (kg)	SIZE (cm) ↓ ↓ ↓
MZ0503700Z900	1	0,372	26,17	118x66x112

0000SE0104FAZ	Anti-bacterial plastic bucket 4 L with blue upper plastic handle	1 pc.
0000SE0104FBZ	Anti-bacterial plastic bucket 4 L with red upper plastic handle	1 pc.
0000SE0104FCZ	Anti-bacterial plastic bucket 4 L with yellow upper plastic handle	1 pc.
0000SE0104FFZ	Anti-bacterial plastic bucket 4 L with green upper plastic handle	1 pc.
0000SE1322FAZ	TOP-DOWN - green antibacterial plastic bucket with blue plastic handle and watertight lid, 20 l	1 pc.
0000SE1322FBZ	TOP-DOWN - green antibacterial plastic bucket with red plastic handle and hermetic cover, 20 l	1 pc.
0000SM00165Z	Anti-bacterial set of T-shaped closing plugs for vertical frames (6 pcs)	2 pcs
020P2199906EZ	Central antibacterial plastic tray, female/female fitting, with plugs	1 pc.
P1191100EZ	Anti-bacterial side plastic basket	2 pcs
P1229906FZ	Anti-bacterial plastic sliding drawer 22 L without locking key	1 pc.
P166031EZ	Long base for antibacterial Alpha trolley with 5 rubber wheels Ø 125 mm	1 pc.
P1909948EZ	Antibacterial plastic mop holder fitting the base of the Alpha trolley	2 pcs
P2039903FZ	Anti-bacterial vertical frame, 1 side with 6 slides + 1 side for T-plugs, complete with screws and plugs	2 pcs
P2909920EZ	Anti-bacterial closing profile for central basket/bag holder complete with screws and plugs	1 pc.
P8161114EZ	2x60 antibacterial plastic waste bag holder, male fitting, with handle clips, dustpan hook, screws and plugs	1 pc.

⚠ ACCESSORIES TO BE ORDERED SEPARATELY

0000AT0170A	Plastified bag 48x97 cm, capacity 60 L, blu	1 pc.
0000AT0170B	Plastified bag 48x97 cm, capacity 60 L, red	1 pc.
0000CP1204FZ	Green anti-bacterial plastic cover with hinges for buckets 4 L art. 0000SE0104	4 pcs
P291918FZ	Green anti-bacterial plastic cover for bag holder 120 L	1 pc.

REF.	PCK	VOLUME (m³)	GROSS WEIGHT (kg)	SIZE (cm) ↓ ↓ ↓
MZ0603700Z900	1	0,372	28,47	118x66x112

0000SE0104FAZ	Anti-bacterial plastic bucket 4 L with blue upper plastic handle	1 pc.
0000SE0104FBZ	Anti-bacterial plastic bucket 4 L with red upper plastic handle	1 pc.
0000SE0104FCZ	Anti-bacterial plastic bucket 4 L with yellow upper plastic handle	1 pc.
0000SE0104FFZ	Anti-bacterial plastic bucket 4 L with green upper plastic handle	1 pc.
0000SE1322FAZ	TOP-DOWN - green antibacterial plastic bucket with blue plastic handle and watertight lid, 20 l	1 pc.
0000SE1322FBZ	TOP-DOWN - green antibacterial plastic bucket with red plastic handle and hermetic cover, 20 l	1 pc.
0000SM00165Z	Anti-bacterial set of T-shaped closing plugs for vertical frames (6 pcs)	2 pcs
020P2199906EZ	Central antibacterial plastic tray, female/female fitting, with plugs	1 pc.
P1191100EZ	Anti-bacterial side plastic basket	2 pcs
P1229906FZ	Anti-bacterial plastic sliding drawer 22 L without locking key	1 pc.
P166031EZ	Long base for antibacterial Alpha trolley with 5 rubber wheels Ø 125 mm	1 pc.
P1909948EZ	Antibacterial plastic mop holder fitting the base of the Alpha trolley	2 pcs
P2039903FZ	Anti-bacterial vertical frame, 1 side with 6 slides + 1 side for T-plugs, complete with screws and plugs	2 pcs
P2909920EZ	Anti-bacterial closing profile for central basket/bag holder complete with screws and plugs	1 pc.
P3909953FZ	Anti-bacterial fixed side wall with fixing pins	1 pc.
P3909954FZ	Plastic antibacterial door with fixing pins	1 pc.
P8161114EZ	2x60 antibacterial plastic waste bag holder, male fitting, with handle clips, dustpan hook, screws and plugs	1 pc.

⚠ ACCESSORIES TO BE ORDERED SEPARATELY

0000AT0170A	Plastified bag 48x97 cm, capacity 60 L, blu	1 pc.
0000AT0170B	Plastified bag 48x97 cm, capacity 60 L, red	1 pc.
0000CP1204FZ	Green anti-bacterial plastic cover with hinges for buckets 4 L art. 0000SE0104	4 pcs
P291918FZ	Green anti-bacterial plastic cover for bag holder 120 L	1 pc.

A-B PLUS anti-bacterial system



A-B PLUS

ALPHA A-B PLUS 0603706 - antibacterial plastic trolley with Click Safe system

NEW

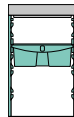

REF.	PCK	VOLUME (m³)	GROSS WEIGHT (kg)	SIZE (cm)
MZ0603706Z901	1	0,372	20,67	118x66x112

ALPHA A-B PLUS 0803701 - plastic anti-bacterial trolley

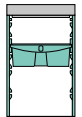

REF.	PCK	VOLUME (m³)	GROSS WEIGHT (kg)	SIZE (cm)
MZ0803701Z900	1	0,261	31,05	120x66x112

Click Safe system requires the use of the corresponding Click Safe folding mop holder (See the catalog under the line Soaking and Floor Washing Systems - system with pockets)

0000SE0104FAZ	Anti-bacterial plastic bucket 4 L with blue upper plastic handle	1 pc.
0000SE0104FBZ	Anti-bacterial plastic bucket 4 L with red upper plastic handle	1 pc.
0000SE0104FCZ	Anti-bacterial plastic bucket 4 L with yellow upper plastic handle	1 pc.
0000SE0104FFZ	Anti-bacterial plastic bucket 4 L with green upper plastic handle	1 pc.
0000SE1222FBZ	Green antibacterial plastic bucket 20 lt, with red plastic handle and hermetic cover	1 pc.
0000SE1322FAZ	TOP-DOWN - green antibacterial plastic bucket with blue plastic handle and watertight lid, 20 l	1 pc.
0000SM00165Z	Anti-bacterial set of T-shaped closing plugs for vertical frames (6 pcs)	2 pcs
020P2199906EZ	Central antibacterial plastic tray, female/female fitting, with plugs	1 pc.
P1191100EZ	Anti-bacterial side plastic basket	1 pc.
P1229906FZ	Anti-bacterial plastic sliding drawer 22 L without locking key	1 pc.
P165000EZ	Anti-bacterial supporting plastic plate for bases Alpha trolley	1 pc.
P166031EZ	Long base for antibacterial Alpha trolley with 5 rubber wheels Ø 125 mm	1 pc.
P190360U	Plastic lid for Click Safe system	1 pc.
P1909948EZ	Antibacterial plastic mop holder fitting the base of the Alpha trolley	2 pcs
P2039903FZ	Anti-bacterial vertical frame, 1 side with 6 slides + 1 side for T-plugs, complete with screws and plugs	2 pcs
P2909920EZ	Anti-bacterial closing profile for central basket/bag holder complete with screws and plugs	1 pc.
P3909953FZ	Anti-bacterial fixed side wall with fixing pins	1 pc.
P3909954FZ	Plastic antibacterial door with fixing pins	1 pc.
P8161114EZ	2x60 antibacterial plastic waste bag holder, male fitting, with handle clips, dustpan hook, screws and plugs	1 pc.

⚠ ACCESSORIES TO BE ORDERED SEPARATELY

0000AT0170A	Plastified bag 48x97 cm, capacity 60 L, blu	1 pc.
0000AT0170B	Plastified bag 48x97 cm, capacity 60 L, red	1 pc.
0000CP1204FZ	Green anti-bacterial plastic cover with hinges for buckets 4 L art. 0000SE0104	4 pcs
P291918FZ	Green anti-bacterial plastic cover for bag holder 120 L	1 pc.

0000SE0104FAZ	Anti-bacterial plastic bucket 4 L with blue upper plastic handle	1 pc.
0000SE0104FBZ	Anti-bacterial plastic bucket 4 L with red upper plastic handle	1 pc.
0000SE0104FCZ	Anti-bacterial plastic bucket 4 L with yellow upper plastic handle	1 pc.
0000SE0104FFZ	Anti-bacterial plastic bucket 4 L with green upper plastic handle	1 pc.
0000SE1322FAZ	TOP-DOWN - green antibacterial plastic bucket with blue plastic handle and watertight lid, 20 l	1 pc.
0000SE1322FBZ	TOP-DOWN - green antibacterial plastic bucket with red plastic handle and hermetic cover, 20 l	1 pc.
0000SM00165Z	Anti-bacterial set of T-shaped closing plugs for vertical frames (6 pcs)	2 pcs
020P2199906EZ	Central antibacterial plastic tray, female/female fitting, with plugs	1 pc.
60072EZ	Anti-bacterial handle holder for Alpha bag holder and closing profile	2 pcs
60082EZ	Anti-bacterial hook	1 pc.
P1191100EZ	Anti-bacterial side plastic basket	2 pcs
P1229906FZ	Anti-bacterial plastic sliding drawer 22 L without locking key	1 pc.
P166031EZ	Long base for antibacterial Alpha trolley with 5 rubber wheels Ø 125 mm	1 pc.
P190908U	Shock absorbing piston for a soft closing of the cover	2 pcs
P1909948EZ	Antibacterial plastic mop holder fitting the base of the Alpha trolley	2 pcs
P2039903FZ	Anti-bacterial vertical frame, 1 side with 6 slides + 1 side for T-plugs, complete with screws and plugs	2 pcs
P2909912EZ	Divider for plastic anti-bacterial bag holder 150 L	1 pc.
P2909920EZ	Anti-bacterial closing profile for central basket/bag holder complete with screws and plugs	1 pc.
P2909946FZ	Anti-bacterial plastic cover for bag holder 150 L	1 pc.
P3909952FZ	Plastic antibacterial door for bag holder, with fixing pins	1 pc.
P3909953FZ	Anti-bacterial fixed side wall with fixing pins	3 pcs
P3909954FZ	Plastic antibacterial door with fixing pins	1 pc.
P8169905EZ	Anti-bacterial bag holder 150 L (male version) complete with screws and plugs	1 pc.

⚠ ACCESSORIES TO BE ORDERED SEPARATELY

0000AT0160A	Plastified bag 56x92 cm, capacity 80 L, blu	1 pc.
0000AT0160B	Plastified bag 56x92 cm, capacity 80 L, red	1 pc.
0000CP1204FZ	Green anti-bacterial plastic cover with hinges for buckets 4 L art. 0000SE0104	4 pcs



PRODUCT PARTIALLY MADE OF PLASTIC COMPONENTS CERTIFIED PSV - PLASTIC SECOND LIFE

A-B PLUS

ALPHA A-B PLUS 0803705 - antibacterial plastic trolley with Click Safe system

NEW

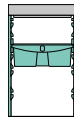

REF.	PCK	VOLUME (m³)	GROSS WEIGHT (kg)	SIZE (cm)
MZ0803705Z901	1	0,372	25,82	120x66x112

ALPHA A-B PLUS 3803702- plastic anti-bacterial trolley

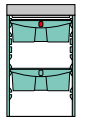

REF.	PCK	VOLUME (m³)	GROSS WEIGHT (kg)	SIZE (cm)
MZ3803702Z900	1	0,372	32,77	120x66x110

Click Safe system requires the use of the corresponding Click Safe folding mop holder (See the catalog under the line Soaking and Floor Washing Systems - system with pockets)

0000SE0104FAZ	Anti-bacterial plastic bucket 4 L with blue upper plastic handle	1 pc.
0000SE0104FBZ	Anti-bacterial plastic bucket 4 L with red upper plastic handle	1 pc.
0000SE0104FCZ	Anti-bacterial plastic bucket 4 L with yellow upper plastic handle	1 pc.
0000SE0104FFZ	Anti-bacterial plastic bucket 4 L with green upper plastic handle	1 pc.
0000SE1222FBZ	Green antibacterial plastic bucket 20 lt, with red plastic handle and hermetic cover	1 pc.
0000SE1322FAZ	TOP-DOWN - green antibacterial plastic bucket with blue plastic handle and watertight lid, 20 l	1 pc.
0000SM00165Z	Anti-bacterial set of T-shaped closing plugs for vertical frames (6 pcs)	2 pcs
020P2199906EZ	Central antibacterial plastic tray, female/female fitting, with plugs	1 pc.
60072EZ	Anti-bacterial handle holder for Alpha bag holder and closing profile	2 pcs
60082EZ	Anti-bacterial hook	1 pc.
P1191100EZ	Anti-bacterial side plastic basket	1 pc.
P1229906FZ	Anti-bacterial plastic sliding drawer 22 L without locking key	1 pc.
P165000EZ	Anti-bacterial supporting plastic plate for bases Alpha trolley	1 pc.
P166031EZ	Long base for antibacterial Alpha trolley with 5 rubber wheels Ø 125 mm	1 pc.
P190360U	Plastic lid for Click Safe system	1 pc.
P190908U	Shock absorbing piston for a soft closing of the cover	2 pcs
P1909948EZ	Antibacterial plastic mop holder fitting the base of the Alpha trolley	2 pcs
P2039903FZ	Anti-bacterial vertical frame, 1 side with 6 slides + 1 side for T-plugs, complete with screws and plugs	2 pcs
P2909912EZ	Divider for plastic anti-bacterial bag holder 150 L	1 pc.
P2909920EZ	Anti-bacterial closing profile for central basket/bag holder complete with screws and plugs	1 pc.
P2909946FZ	Anti-bacterial plastic cover for bag holder 150 L	1 pc.
P3909952FZ	Plastic antibacterial door for bag holder, with fixing pins	1 pc.
P3909953FZ	Anti-bacterial fixed side wall with fixing pins	3 pcs
P3909954FZ	Plastic antibacterial door with fixing pins	1 pc.
P8169905EZ	Anti-bacterial bag holder 150 L (male version) complete with screws and plugs	1 pc.

ACCESSORIES TO BE ORDERED SEPARATELY

0000AT0160A	Plastified bag 56x92 cm, capacity 80 L, blu	1 pc.
0000AT0160B	Plastified bag 56x92 cm, capacity 80 L, red	1 pc.
0000CP1204FZ	Green anti-bacterial plastic cover with hinges for buckets 4 L art. 0000SE0104	4 pcs

0000SE0204FAZ	Antibacterial plastic bucket 4L with blue recessed upper plastic handle	1 pc.
0000SE0204FBZ	Antibacterial plastic bucket 4L with red recessed upper plastic handle	1 pc.
0000SE0204FCZ	Antibacterial plastic bucket 4L with yellow recessed upper plastic handle	1 pc.
0000SE0204FFZ	Antibacterial plastic bucket 4L with green recessed upper plastic handle	1 pc.
0000SE1322FAZ	TOP-DOWN - green antibacterial plastic bucket with blue plastic handle and watertight lid, 20 l	1 pc.
0000SM00165Z	Anti-bacterial set of T-shaped closing plugs for vertical frames (6 pcs)	2 pcs
60072EZ	Anti-bacterial handle holder for Alpha bag holder and closing profile	2 pcs
60082EZ	Anti-bacterial hook	1 pc.
P1229906FZ	Anti-bacterial plastic sliding drawer 22 L without locking key	1 pc.
P165000EZ	Anti-bacterial supporting plastic plate for bases Alpha trolley	1 pc.
P166031EZ	Long base for antibacterial Alpha trolley with 5 rubber wheels Ø 125 mm	1 pc.
P190908U	Shock absorbing piston for a soft closing of the cover	2 pcs
P1909937EZ	Anti-bacterial plastic lift for buckets, with holes for bottles, fitting drawers 22 and 40 L	1 pc.
P1909948EZ	Antibacterial plastic mop holder fitting the base of the Alpha trolley	2 pcs
P2039903FZ	Anti-bacterial vertical frame, 1 side with 6 slides + 1 side for T-plugs, complete with screws and plugs	2 pcs
P2229906FZ	Anti-bacterial plastic sliding drawer 22 L with locking key	1 pc.
P2909912EZ	Divider for plastic anti-bacterial bag holder 150 L	1 pc.
P2909920EZ	Anti-bacterial closing profile for central basket/bag holder complete with screws and plugs	1 pc.
P2909946FZ	Anti-bacterial plastic cover for bag holder 150 L	1 pc.
P3199903EZ	Antibacterial plastic central ring for 4l buckets complete with lockable lid and two soft-close pistons	1 pc.
P3909952FZ	Plastic antibacterial door for bag holder, with fixing pins	1 pc.
P3909953FZ	Anti-bacterial fixed side wall with fixing pins	3 pcs
P3909954FZ	Plastic antibacterial door with fixing pins	1 pc.
P8169905EZ	Anti-bacterial bag holder 150 L (male version) complete with screws and plugs	1 pc.

ACCESSORIES TO BE ORDERED SEPARATELY

0000AT0160A	Plastified bag 56x92 cm, capacity 80 L, blu	1 pc.
0000AT0160B	Plastified bag 56x92 cm, capacity 80 L, red	1 pc.





A-B PLUS

Mop holders, mops and cloths for A-B PLUS system

CLICK SAFE - plastic foldable mop holder with Lock System fitting

NEW



REF.	NOTES	PCK	VOLUME (m³)	GROSS WEIGHT (kg)	SIZE (cm) ↓ ↓ ↓
0000TP0312U		10	0,024	0,4	40x11

UNIKO - foldable anti-bacterial plastic mop holder with mop fixing clip and Lock System



REF.	NOTES	PCK	VOLUME (m³)	GROSS WEIGHT (kg)	SIZE (cm) ↓ ↓ ↓
0000TD0320FZ		10	0,023	5,69	40x11

Mop **A-B PLUS** anti-bacterial ultra-microfiber pocket mop



REF.	NOTES	PCK	VOLUME (m³)	GROSS WEIGHT (kg)	SIZE (cm) ↓ ↓ ↓
0000PN04012EZ		25	0,028	3,32	40x13

Ideal for hospital indoor floors with a medium degree of dirt

Aluminium mop holder and anti-bacterial plastic components with strips for strap tape system and Lock System fitting



REF.	NOTES	PCK	VOLUME (m³)	GROSS WEIGHT (kg)	SIZE (cm) ↓ ↓ ↓
0000TA0340FZ		12	0,018	4,21	40

A-B PLUS anti-bacterial ultra-microfiber mop with strap tape system and colour-coded tag



REF.	NOTES	PCK	VOLUME (m³)	GROSS WEIGHT (kg)	SIZE (cm) ↓ ↓ ↓
0000PN03012EZ		25	0,015	1,86	40

Ideal for hospital indoor floors with a medium degree of dirt

MULTI-T A-B PLUS - anti-bacterial ultra-microfiber multipurpose cloth



REF.	NOTES	NET WEIGHT (kg)	PCK	VOLUME (m³)	GROSS WEIGHT (kg)	SIZE (cm) ↓ ↓ ↓
TCH101410		0,056	5	0,002	0,28	40x40
TCH101420		0,056	5	0,002	0,28	40x40
TCH101430		0,056	5	0,002	0,28	40x40
TCH101440		0,056	5	0,002	0,28	40x40
TCH101419	pck.: 40 polybags with 5 pcs	11,2	1	0,08	11,6	40x40
TCH101429	pck.: 40 polybags with 5 pcs	11,2	1	0,08	11,6	40x40
TCH101439	pck.: 40 polybags with 5 pcs	11,2	1	0,08	11,6	40x40
TCH101449	pck.: 40 polybags with 5 pcs	11,2	1	0,08	11,6	40x40

With anti-bacterial treatment, it removes up to 99,98% of bacteria and fungi - Cloth for any surface and for very dirty environments - Resistant, it removes and keeps dirt - Weight 310 gr/mq

A-B PLUS

A-B PLUS handles

Anodized aluminium telescopic handle with anti-bacterial components - 2 pcs



REF.	NOTES	PCK	VOLUME (m³)	GROSS WEIGHT (kg)	SIZE (cm) ↓ ↓ ↓
0000AM3040FZ		10	0,014	4,69	182

Extendible from 100 to 182 cm - External tube ø 26 mm, internal tube ø 23 mm

MOVE - plastic handle holder for ø 26 mm handles



REF.	NOTES
0000SM00147FZ	

A-B PLUS Components

Anti-bacterial long plastic base for Alpha trolley



REF.	NOTES	SIZE (cm) ↓ ↓ ↓
P166031EZ	with five ø 125 mm rubber wheels	91x52

Anti-bacterial supporting plastic plate for bases Alpha trolley



REF.	NOTES	SIZE (cm) ↓ ↓ ↓
P165000EZ		48x22x15

A-B PLUS anti-bacterial system



A-B PLUS

Anti-bacterial vertical frame, 1 side with 6 slides + 1 side for T-plugs, complete with screws and plugs



REF.

NOTES

P2039903FZ

Anti-bacterial vertical frame, 2 sides with slides, complete with screws and plugs



REF.

NOTES

P2039904FZ

Anti-bacterial set of T-shaped closing plugs for vertical frames (6 pcs)



REF.

NOTES

0000SM00165Z

Anti-bacterial fixed side wall with fixing pins



REF.

NOTES

P3909953FZ

Plastic antibacterial door with fixing pins



REF.

NOTES

P3909954FZ

A-B PLUS

A-B PLUS

Antibacterial plastic door for 150l waste bag holder, with fastening pins



REF.	NOTES
P3909952FZ	

Anti-bacterial central plastic basket (female-female version) with plugs



REF.	NOTES
020P2199906EZ	internal sizes 31x48x8 cm

Anti-bacterial central plastic basket (male-female version) complete with screws and plugs



REF.	NOTES
020P2199907EZ	internal sizes 31x48x8 cm

Anti-bacterial central plastic frame with cover with locking key and 2 shock absorbing pistons for versions with buckets 4 L



REF.	NOTES
P3199903EZ	

Anti-bacterial side plastic basket



REF.	NOTES
P1191100EZ	internal sizes 22x49x11,5 cm

Anti-bacterial closing profile for central basket/bag holder complete with screws and plugs



REF.	NOTES
P2909920EZ	



A-B PLUS

Anti-bacterial closing profile with push-grip for central basket complete with screws and plugs



REF.	NOTES
P2909921EZ	

2x60 antibacterial plastic waste bag holder, male fitting, with 2 handle clips, 2 fixed dustpan hooks, screws and plugs

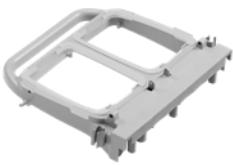

REF.	NOTES
P8161114EZ	

Anti-bacterial bag holder 150 L (male version) complete with screws and plugs

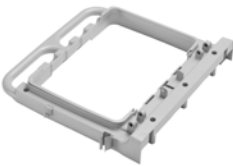

REF.	NOTES
P8169905EZ	

Divider for plastic anti-bacterial bag holder 150 L



REF.	NOTES
P2909912EZ	

Anti-bacterial plastic sliding drawer without locking key



REF.	NOTES	CAPACITY (L)
P1229906FZ	internal dimensions 40,5x34x16 cm	22
P1229907FZ	internal dimensions 40x34x33,5 cm	40



Anti-bacterial plastic slider drawer with locking key



REF.	NOTES	CAPACITY (L)
P2229906FZ	internal dimensions 40,5x34x16 cm	22
P2229907FZ	internal dimensions 40x34x33,5 cm	40



A-B PLUS

Anti-bacterial plastic lift for buckets, with holes for bottles, fitting drawers 22 and 40 L



REF.	NOTES
P1909937EZ	

Anti-bacterial green plastic bucket 4 L with coloured plastic handle



REF.	NOTES	SIZE (cm)
		↓ ↓ ↓
0000SE0104FAZ	with blue handle	17x25,5x19,5
0000SE0104FBZ	with red handle	17x25,5x19,5
0000SE0104FCZ	with yellow handle	17x25,5x19,5
0000SE0104FFZ	with green handle	17x25,5x19,5



Anti-bacterial green plastic bucket 4 L with coloured upper plastic handle



REF.	NOTES	SIZE (cm)
		↓ ↓ ↓
0000SE0204FAZ	with blue handle	16,5x21x22,5
0000SE0204FBZ	with red handle	16,5x21x22,5
0000SE0204FCZ	with yellow handle	16,5x21x22,5
0000SE0204FFZ	with green handle	16,5x21x22,5



TOP-DOWN® - anti-bacterial green plastic bucket with coloured plastic handle and hermetic cover



REF.	NOTES	CAPACITY (L)	SIZE (cm)
			↓ ↓ ↓
0000SE1322FAZ	with blue handle	20	24x55x27
0000SE1322FBZ	with red handle	20	24x55x27

Green antibacterial plastic bucket with colored plastic handle and hermetic cover



REF.	NOTES	SIZE (cm)
		↓ ↓ ↓
0000SE1222FBZ		24x55x27

Plastic lid for Click Safe system



REF.	NOTES	SIZE (cm)
		↓ ↓ ↓
P190360U		55x23x12

NEW



A-B PLUS

Anti-bacterial handle holder for Alpha bag holder and closing profile



REF.	NOTES
60072EZ	

Anti-bacterial hook



REF.	NOTES
60082EZ	

Antibacterial plastic mop holder fitting the base of the Alpha trolley



REF.	NOTES
P1909948EZ	

Accessories for A-B PLUS

JOBBY - plastic bin with aluminium handle and cover



REF.	NOTES	PCK	VOLUME (m³)	GROSS WEIGHT (kg)	SIZE (cm) ↓ ↓ ↓
00010105U		6	0,073	5,35	29x28x87,5



With serrated edge for an easy removal of the dirt from the broom

SPARK - cloth holder with rubber blades



REF.	NOTES	PCK	VOLUME (m³)	GROSS WEIGHT (kg)	SIZE (cm) ↓ ↓ ↓
002072001U		1	0,006	0,85	60x11

Autoclavable

A-B PLUS

4 lt anti-bacterial plastic bucket with handle and hermetic cover with central slot for cloth extraction



REF.	NOTES		PCK	VOLUME (m³)	GROSS WEIGHT (kg)	SIZE (cm)
0000SE3104FAZ	with blue handle		5	0,028	2,65	17x25,5x25
0000SE3104FBZ	with red handle		5	0,028	2,65	17x25,5x25
0000SE3104FCZ	with yellow handle		5	0,028	2,65	17x25,5x25
0000SE3104FFZ	with green handle		5	0,028	2,65	17x25,5x25



To be used with manual disposable TNT MONO-ROLL cloth art. 00PU0203000

Anti-bacterial pedal set for Alpha trolleys with long base, closed bag holder 150 L and wheels ø 125 mm



REF.	NOTES
P2909918FZ	

Only for bases with 4 wheels

Anti-bacterial plastic cover for bag holder 120 L



REF.	NOTES
P291918FZ	



Please, require also no. 2 shock absorbing pistons art. P190908U for a perfect soft closing

Anti-bacterial plastic cover for bag holder 150 L



REF.	NOTES
P2909946FZ	



Please, require also no. 2 shock absorbing pistons art. P190908U for a perfect soft closing

Shock absorbing piston for a soft closing of the cover



REF.	NOTES
P190908U	





A-B PLUS

Green anti-bacterial plastic cover with hinges



REF.	NOTES
0000CP1204FZ	for bucket 4 L art. 0000SE0104

Anti-bacterial plastic divider for Top-Down® bucket 20 L



REF.	NOTES
P190350FZ	

Anti-bacterial pierced plastic sieve for Top-Down® bucket 20 L



REF.	NOTES
P1190042FZ	

Ideal for a uniform distribution of the cleaning solution - For a quick pre-soaking (max 15 minutes)



Waste collection

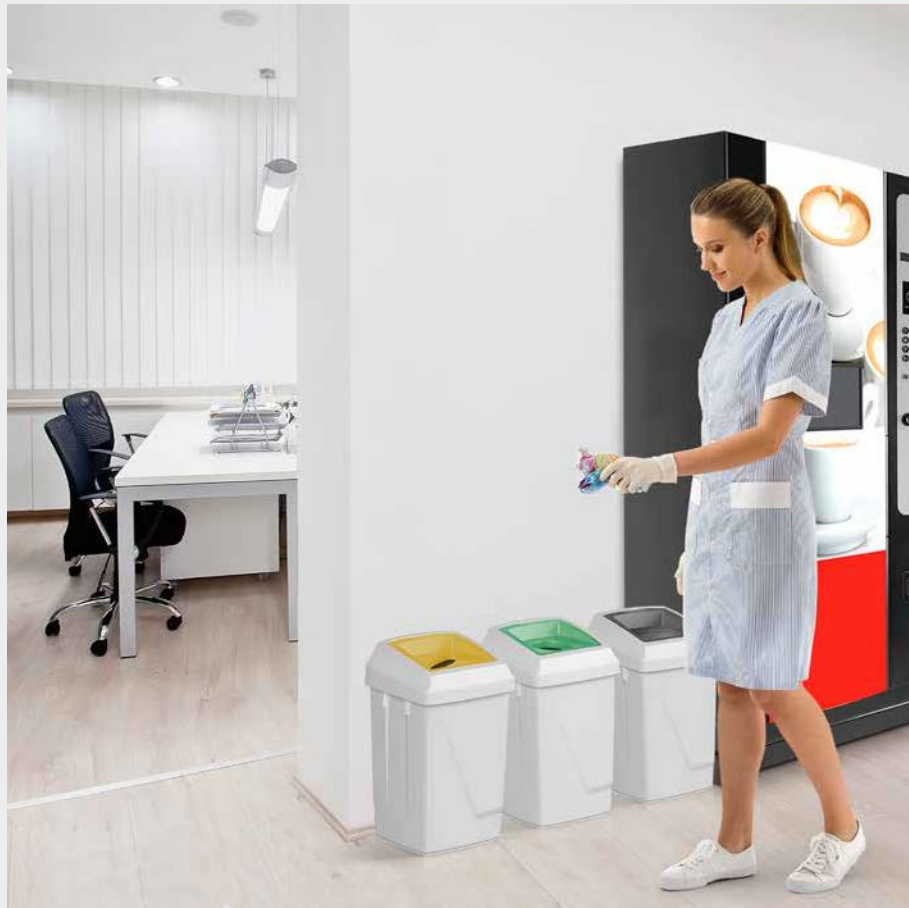

Bins for separate waste collection

Sanitary bins

Waste trolleys

Paper holders



BINS FOR SEPARATE WASTE COLLECTION

SANITARY BINS

WASTE TROLLEYS

PAPER HOLDERS

NEW Atlas: the waste collection that makes a difference

Atlas is a range of 50 L bins characterized by a modern, stylish and functional design, specifically conceived to make waste collection easier and more convenient.



ATLAS PRESS

Compliant with H.A.C.C.P. rules, avoids contact with hands thanks to the pedal. The lid can be **graphically customized** to turn the bin into a means of communication or to fit the environment.



ATLAS

Equipped with an asymmetrical swing lid with opening lock, freely **customizable with images, graphics or logos**.

Available also in the **ATLAS ECO** version, with a high percentage of recycled plastic.

ATLAS FIT

Range of bins with shaped covers to **make sorting waste collection intuitive**. The inserts are available in **color-code** to customize the collection of different types of waste, making handling easier.



Atlas bins

ATLAS PRESS - plastic white bin with lid and pedal

NEW



REF.	NOTES	CAPACITY (L)	PCK	VOLUME (m³)	GROSS WEIGHT (kg)	SIZE (cm)
0000CO8050D		50	3	0,127	7,43	37x40,5x57
0001CO8050D		50	1	0,07	2,91	37x40,5x57



Advised bags size: 65x65 cm



BINS FOR SEPARATE WASTE COLLECTION

SANITARY BINS

WASTE TROLLEYS

PAPER HOLDERS

ATLAS - white plastic bin with swing lid

NEW

REF.	NOTES	CAPACITY (L)	PCK	VOLUME (m³)	GROSS WEIGHT (kg)	SIZE (cm) ↓ ↓ ↓
0000CO7050D		50	4	0,15	8,09	31,5x39x67
0001CO7050D		50	1	0,07	2,69	31,5x39x67



Advised bags size: 65x65 cm

ATLAS ECO - plastic grey bin with swing lid

NEW

REF.	NOTES	CAPACITY (L)	PCK	VOLUME (m³)	GROSS WEIGHT (kg)	SIZE (cm) ↓ ↓ ↓
0000CO7050U1		50	4	0,15	8,09	31,5x39x67
0001CO7050U1		50	1	0,07	2,69	31,5x39x67



Advised bags size: 65x65 cm

ATLAS FIT - plastic white bin with shaped lid for waste collection

NEW

REF.	NOTES	CAPACITY (L)	PCK	VOLUME (m³)	GROSS WEIGHT (kg)	SIZE (cm) ↓ ↓ ↓	
0000CO7150DL1	Insert for paper		50	3	0,094	5,29	31,5x39x61
0000CO7150DC1	Insert for paper		50	3	0,094	5,29	31,5x39x61
0000CO7250DB1	Insert for glass/plastic/metal		50	3	0,094	5,27	31,5x39x61
0000CO7250DC1	Insert for glass/plastic/metal		50	3	0,094	5,27	31,5x39x61
0000CO7250DF3	Insert for glass/plastic/metal		50	3	0,094	5,27	31,5x39x61
0000CO7350DU	insert for mixed waste		50	3	0,094	5,14	31,5x39x61
0000CO7450DG1	insert for organic waste		50	3	0,094	5,47	31,5x39x61
0000CO7450DU	insert for organic waste		50	3	0,094	5,47	31,5x39x61
0001CO7150DL1	Insert for paper		50	1	0,07	2,61	31,5x39x61
0001CO7150DC1	Insert for paper		50	1	0,07	2,61	31,5x39x61
0001CO7250DB1	Insert for glass/plastic/metal		50	1	0,07	2,6	31,5x39x61
0001CO7250DC1	Insert for glass/plastic/metal		50	1	0,07	2,6	31,5x39x61
0001CO7250DF3	Insert for glass/plastic/metal		50	1	0,07	2,6	31,5x39x61
0001CO7350DU	insert for mixed waste		50	1	0,07	2,56	31,5x39x61
0001CO7450DG1	insert for organic waste		50	1	0,07	2,67	31,5x39x61
0001CO7450DU	insert for organic waste		50	1	0,07	2,67	31,5x39x61



Advised bags size: 65x65 cm



BINS FOR SEPARATE WASTE COLLECTION

SANITARY BINS

WASTE TROLLEYS

PAPER HOLDERS

White plastic bin without cover

NEW



REF.	NOTES	PCK	VOLUME (m³)	GROSS WEIGHT (kg)	SIZE (cm)
P190071D		4	0,15	5,72	30x38x50
P190071U1		4	0,15	5,72	30x38x50

Complete cover for Atlas bin

NEW



REF.	NOTES
P190072D	
P190072U1	

Complete cover for Atlas Fit bin

NEW



REF.	NOTES
P190073DC1	Insert for paper
P190073DL1	Insert for paper
P190074DB1	Insert for glass/plastic/metal
P190074DC1	Insert for glass/plastic/metal
P190074DF3	Insert for glass/plastic/metal
P190075DU	insert for mixed waste
P290074DG1	insert for organic waste
P290074DU	insert for organic waste

Sticky label with separate waste collection design for cover of Atlas Fit container

NEW



REF.	NOTES
801400	

BINS FOR SEPARATE WASTE COLLECTION

SANITARY BINS

WASTE TROLLEYS

PAPER HOLDERS

Patty bins

PATTY - plastic white bin with coloured swing lid

REF.	NOTES		CAPACITY (L)	PCK	VOLUME (m³)	GROSS WEIGHT (kg)	SIZE (cm)
8369	with white swing cover		25	4	0,095	5,87	27x33x52
8369A	with blue swing cover		25	4	0,095	5,87	27x33x52
8369B	with red swing cover		25	4	0,095	5,87	27x33x52
8369C	with yellow swing cover		25	4	0,095	5,87	27x33x52
8369E	with grey swing cover		25	4	0,095	5,87	27x33x52
8369F	with green swing cover		25	4	0,095	5,87	27x33x52
8369G	with brown swing cover		25	4	0,095	5,87	27x33x52



Advised bag size: 50x60 cm

PATTY - plastic white bin with coloured swing lid

REF.	NOTES		CAPACITY (L)	PCK	VOLUME (m³)	GROSS WEIGHT (kg)	SIZE (cm)
8162	with white swing cover		12	4	0,041	2,76	20x25x40
8162A	with blue swing cover		12	4	0,041	2,76	20x25x40
8162B	with red swing cover		12	4	0,041	2,76	20x25x40
8162C	with yellow swing cover		12	4	0,041	2,76	20x25x40
8162E	with grey swing cover		12	4	0,041	2,76	20x25x40
8162F	with green swing cover		12	4	0,041	2,76	20x25x40
8162G	with brown swing cover		12	4	0,041	2,76	20x25x40
8169	with white swing cover		25	4	0,095	5,63	27x33x52
8169A	with blue swing cover		25	4	0,095	5,63	27x33x52
8169B	with red swing cover		25	4	0,095	5,63	27x33x52
8169C	with yellow swing cover		25	4	0,095	5,63	27x33x52
8169E	with grey swing cover		25	4	0,095	5,63	27x33x52
8169F	with green swing cover		25	4	0,095	5,63	27x33x52
8169G	with brown swing cover		25	4	0,095	5,63	27x33x52



Advised bag size: 50x60 cm

Linking system for Patty bins



REF.	NOTES
P190938D	for Patty 25 L





BINS FOR SEPARATE WASTE COLLECTION

SANITARY BINS

WASTE TROLLEYS

PAPER HOLDERS

White plastic bin without cover



REF.	NOTES	CAPACITY (L)	PCK	VOLUME (m³)	GROSS WEIGHT (kg)	SIZE (cm) ↓ ↓ ↓
8162/1		12	4	0,041	1,92	19x24,5x30
8169/1		25	4	0,095	4,31	25x32,5x40



White cover with coloured swing for Patty bin



REF.	NOTES	
60193	for Patty 12 L	
60193A	for Patty 12 L	
60193B	for Patty 12 L	
60193C	for Patty 12 L	
60193E	for Patty 12 L	
60193F	for Patty 12 L	
60193G	for Patty 12 L	
60185	for Patty 25 L	
60185A	for Patty 25 L	
60185B	for Patty 25 L	
60185C	for Patty 25 L	
60185E	for Patty 25 L	
60185F	for Patty 25 L	
60185G	for Patty 25 L	

Patty bins with pedal

PATTY - plastic white bin with cover and pedal



REF.	NOTES	CAPACITY (L)	PCK	VOLUME (m³)	GROSS WEIGHT (kg)	SIZE (cm) ↓ ↓ ↓
8169/2	with white cover		4	0,105	6,8	28x34x47
8169/2A	with blue cover		4	0,105	6,8	28x34x47
8169/2B	with red cover		4	0,105	6,8	28x34x47
8169/2C	with yellow cover		4	0,105	6,8	28x34x47
8169/2F	with green cover		4	0,105	6,8	28x34x47



Advised bag size: 50x60 cm



BINS FOR SEPARATE WASTE COLLECTION



SANITARY BINS

WASTE TROLLEYS

PAPER HOLDERS

Plastic bin with handle for Patty bin



REF.	NOTES		CAPACITY (L)	PCK	VOLUME (m³)	GROSS WEIGHT (kg)	SIZE (cm) ↓ ↓ ↓
8168/1A	for Patty cod. 8169/2		10	15	0,194	9,25	13,5x21x36
8168/1B	for Patty cod. 8169/2		10	15	0,194	9,25	1,53x21x36
8168/1U			10	15	0,194	9,25	13,5x21x36





BINS FOR SEPARATE WASTE COLLECTION

SANITARY BINS

WASTE TROLLEYS

PAPER HOLDERS

Sirius waste collection bins:

- **Environmentally friendly:** partly made of plastic components certified **Plastic Second Life** according to the **Green Public Procurements** environmental policies
- **Versatile:** available in the 60L, 30L, 2x30L, 2x15L, 30 + 2x15L and 15 + 2x8L versions for a better separate waste collection
- **Hygienic:** thanks to their round-shaped line
- **Ergonomic:** foot pedal opening cover; built-in pedal to avoid bin upsetting and reduce the overall dimensions of the bin
- **In compliance with HACCP rules:** it is the ideal bin for kitchens, restaurants, canteens and all the environments associated with food processing activities



Available in **white with colored cover** and in **white single color** version



Sirius bins

SIRIUS - plastic white bin with pedal, bag stretcher and coloured cover

REF.	NOTES	CAPACITY (L)	PCK	VOLUME (m³)	GROSS WEIGHT (kg)	SIZE (cm)
0000C03030D	with white cover	30	3	0,148	9,54	37x51x47
0000C03031D	with blue cover	30	3	0,148	9,54	37x51x47
0000C03032D	with red cover	30	3	0,148	9,54	37x51x47
0000C03033D	with yellow cover	30	3	0,148	9,54	37x51x47
0000C03034D	with green cover	30	3	0,148	9,54	37x51x47
0000C03035D	with grey cover	30	3	0,148	9,54	37x51x47
0000C03036D	with brown cover	30	3	0,148	9,54	37x51x47
0000C03060D	with white cover	60	3	0,173	12,81	37x51x67
0000C03061D	with blue cover	60	3	0,173	12,81	37x51x67
0000C03062D	with red cover	60	3	0,173	12,81	37x51x67
0000C03063D	with yellow cover	60	3	0,173	12,81	37x51x67
0000C03064D	with green cover	60	3	0,173	12,81	37x51x67
0000C03065D	with grey cover	60	3	0,173	12,81	37x51x67
0000C03066D	with brown cover	60	3	0,173	12,81	37x51x67



Advised bag size:: 70x40 cm for 30 lt and 70x110 cm for 60 lt

BINS FOR SEPARATE WASTE COLLECTION
SANITARY BINS
WASTE TROLLEYS
PAPER HOLDERS
SIRIUS - plastic white bin with divider, pedal, bag stretcher and coloured cover

REF.	NOTES		CAPACITY (L)	PCK	VOLUME (m³)	GROSS WEIGHT (kg)	SIZE (cm) ↓ ↓ ↓
0000C03130D	with white cover		2x15lt	3	0,148	9,81	37x51x47
0000C03131D	with blue cover		2x15lt	3	0,148	9,81	37x51x47
0000C03132D	with red cover		2x15lt	3	0,148	9,81	37x51x47
0000C03133D	with yellow cover		2x15lt	3	0,148	9,81	37x51x47
0000C03134D	with green cover		2x15lt	3	0,148	9,81	37x51x47
0000C03135D	with grey cover		2x15lt	3	0,148	9,81	37x51x47
0000C03136D	with brown cover		2x15lt	3	0,148	9,81	37x51x47
0000C03160D	with white cover		2x30 L	3	0,173	13,09	37x51x67
0000C03161D	with blue cover		2x30 L	3	0,173	13,09	37x51x67
0000C03162D	with red cover		2x30 L	3	0,173	13,09	37x51x67
0000C03163D	with yellow cover		2x30 L	3	0,173	13,09	37x51x67
0000C03164D	with green cover		2x30 L	3	0,173	13,09	37x51x67
0000C03165D	with grey cover		2x30 L	3	0,173	13,09	37x51x67
0000C03166D	with brown cover		2x30 L	3	0,173	13,09	37x51x67



Advised bag dimensions: 50x60 cm for 15L and 50x70 cm for 30L

SIRIUS - plastic white bin with triple divider, pedal, bag stretcher and coloured cover

REF.	NOTES		CAPACITY (L)	PCK	VOLUME (m³)	GROSS WEIGHT (kg)	SIZE (cm) ↓ ↓ ↓
0000C03230D	with white cover		15 L + 2x8 L	3	0,148	10,05	37x51x47
0000C03231D	with blue cover		15 L + 2x8 L	3	0,148	10,05	37x51x47
0000C03232D	with red cover		15 L + 2x8 L	3	0,148	10,05	37x51x47
0000C03233D	with yellow cover		15 L + 2x8 L	3	0,148	10,05	37x51x47
0000C03234D	with green cover		15 L + 2x8 L	3	0,148	10,05	37x51x47
0000C03235D	with grey cover		15 L + 2x8 L	3	0,148	10,05	37x51x47
0000C03236D	with brown cover		15 L + 2x8 L	3	0,148	10,05	37x51x47
0000C03260D	with white cover		30 L + 2x15 L	3	0,173	13,33	37x51x67
0000C03261D	with blue cover		30 L + 2x15 L	3	0,173	13,33	37x51x67
0000C03262D	with red cover		30 L + 2x15 L	3	0,173	13,33	37x51x67
0000C03263D	with yellow cover		30 L + 2x15 L	3	0,173	13,33	37x51x67
0000C03264D	with green cover		30 L + 2x15 L	3	0,173	13,33	37x51x67
0000C03265D	with grey cover		30 L + 2x15 L	3	0,173	13,33	37x51x67
0000C03266D	with brown cover		30 L + 2x15 L	3	0,173	13,33	37x51x67



Advised bag dimensions: 50x60 cm for 15L and 8L and 50x70 cm for 30L



BINS FOR SEPARATE WASTE COLLECTION

SANITARY BINS

WASTE TROLLEYS

PAPER HOLDERS

Plastic cover for Sirius bins 30 L and 60 L with bag stretcher, cage for deodorant pills and pins



REF.	NOTES
P290934A	
P290934B	
P290934C	
P290934D	
P290934E	
P290934F	
P290934G	

Plastic divider for Sirius bins 30 L and 60 L



REF.	NOTES
P190926D	
P190937D	for 3-hole configurations



Sticky label 11x11,5 cm with image for separate waste collection



REF.	NOTES
701421	with image "metal"
701422	with image "paper"
701424	with design "organic waste"
701425	with image "plastic"
701426	with image "glass"
701428	with design "mixed waste"

Sticky label 11x11,5 cm with image and writing for separate waste collection



REF.	NOTES
701431	with image and writing "metalli"
701432	with image and writing "carta"
701440	with design and writing "organic waste"
701435	with image and writing "plastica"
701436	with image and writing "vetro"
701439	with design and writing "mixed waste"



BINS FOR SEPARATE WASTE COLLECTION

SANITARY BINS

WASTE TROLLEYS

PAPER HOLDERS

Sally bins

SALLY - plastic bin with cover and pedal



REF.	NOTES	CAPACITY (L)	PCK	VOLUME (m³)	GROSS WEIGHT (kg)	SIZE (cm) ↓ ↓ ↓
0000CO1017D		17	3	0,058	4,52	42x20x46
0000CO1023D		23	3	0,067	5,54	42x20x59



Advised bag size: 50x60 cm for 17 lt and 55x65 cm for 23 lt

Rilsan coated wall-fixing support for Sally and Desy bins



REF.	NOTES
R2180400	only for Sally-Desy 17 L

Pick-Up bins

PICK-UP - plastic bin 45 L without wheels, complete with cover and screen printed plastic plate



REF.	NOTES	PCK	VOLUME (m³)	GROSS WEIGHT (kg)	SIZE (cm) ↓ ↓ ↓
3667A	with image "paper"	4	0,095	8,1	51x31,5x30
3667B	with image "metal"	4	0,095	8,1	51x31,5x30
3667C	with image "plastic"	4	0,095	8,1	51x31,5x30
3667E	with image "non-recyclable waste"	4	0,095	8,1	51x31,5x30
3667F	with image "glass"	4	0,095	8,1	51x31,5x30
3667G	with image "organic waste"	4	0,095	8,1	51x31,5x30



PICK-UP - plastic bin 45 L without wheels, complete with cover and white plastic plate



REF.	NOTES	PCK	VOLUME (m³)	GROSS WEIGHT (kg)	SIZE (cm) ↓ ↓ ↓
3667T		4	0,095	8,1	51x31,5x30



Product suitable for contact with food in accordance with European regulations (EC Regulation 1935/2004 and EU Regulation No. 10/2011) - Compliance Declaration attached to the technical sheet



BINS FOR SEPARATE WASTE COLLECTION

SANITARY BINS

WASTE TROLLEYS

PAPER HOLDERS

Plastic bin 45 L without cover for Pick-Up bin



REF.	NOTES	PCK	VOLUME (m³)	GROSS WEIGHT (kg)
3645A		4	0,095	5,82
3645B		4	0,095	5,82
3645C		4	0,095	5,82
3645E		4	0,095	5,82
3645F		4	0,095	5,82
3645G		4	0,095	5,82
3645T		4	0,095	5,82

Plastic cover for Pick-Up bin



REF.	NOTES
3648A	with image "paper"
3648B	with image "metal"
3648C	with image "plastic"
3648E	with image "non-recyclable waste"
3648F	with image "glass"
3648G	with image "organic waste"
3648T	without image

Screen printed plastic plate with image for separate waste collection

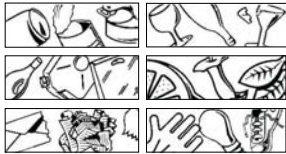

REF.	NOTES
601421	with image "metal"
601422	with image "paper"
601424	with image "organic waste"
601425	with image "plastic"
601426	with image "glass"
601428	with image "non-recyclable waste"

Wheel ø 35 mm



REF.	NOTES
2793	for Prisma, Twin, Top-Down®, Pick-Up, Trend and art. 0000SE1428

Wheel ø 50 mm



REF.	NOTES
7949	For King, Spider, Ro-cket Wheels, Duo Pro System, Prisma, Twin, Top-Down®, Pick-Up, Trend and code 0000SE1428

BINS FOR SEPARATE WASTE COLLECTION

SANITARY BINS

WASTE TROLLEYS

PAPER HOLDERS

Domino bins

DOMINO - plastic bin 25 L with 2 small oval plastic containers and plates

REF.	NOTES	PCK	VOLUME (m³)	GROSS WEIGHT (kg)	SIZE (cm) ↓ ↓ ↓
10300		1	0,045	2,22	46x24,5x36

DOMINO - plastic bin 25 L with 1 small oval plastic container and 1 rectangular plastic container

REF.	NOTES	PCK	VOLUME (m³)	GROSS WEIGHT (kg)	SIZE (cm) ↓ ↓ ↓
10305		1	0,045	2,18	46x24,5x36

Plastic bin 25 L for Domino bin



REF.	NOTES	PCK	VOLUME (m³)	GROSS WEIGHT (kg)	SIZE (cm) ↓ ↓ ↓
10200		4	0,091	5,25	46x24,5x36

Container with cover for Domino



REF.	NOTES	CAPACITY (L)	PCK	VOLUME (m³)	GROSS WEIGHT (kg)
10201	oval	3	4	0,019	1,52
10202	rectangular	2	4	0,009	1,29

Set of coloured plates for Domino bin



REF.	NOTES
10204	



BINS FOR SEPARATE WASTE COLLECTION

SANITARY BINS

WASTE TROLLEYS

PAPER HOLDERS

Bins with metal handle

Plastic bin 12 L with metal handle and cover with locking key



REF.	NOTES	PCK	VOLUME (m³)	GROSS WEIGHT (kg)	SIZE (cm)
0000C02012U		1	0,02	0,88	21x26x36



Thanks to its locking key, it is possible to transport chemical and/or toxic products inside the bin safely

Plastic bin 12 L with cover and metal handle



REF.	NOTES	CAPACITY (L)	PCK	VOLUME (m³)	GROSS WEIGHT (kg)	SIZE (cm)
8145G		12	4	0,052	2,56	22x27x30,5



Steel bins

POIS - stainless steel dustbin with pedal opening system



REF.	NOTES	CAPACITY (L)	PCK	VOLUME (m³)	GROSS WEIGHT (kg)
00005836	ø 17 x 26,5 cm	3	6	0,072	5,04
00005835	ø 20,5 x 29,5 cm	5	6	0,113	7,86
00005830	ø 25 x 40 cm	12	4	0,13	8,26



Oyster bins

OYSTER - wall mounted plastic bin 50 L with pedal and cover



REF.	NOTES	CAPACITY (L)	PCK	VOLUME (m³)	GROSS WEIGHT (kg)	SIZE (cm)
0000CO5050D	with all the components in white colour	50	1	0,123	5,45	39x53,5x81
0000CO5050U	with all the components in grey colour	50	1	0,123	5,45	39x53,5x81
0000CO5050DUD	white, with grey pedal	50	1	0,123	5,45	39x53,5x81
0000CO5050DUA	white, with grey pedal and blue cover	50	1	0,123	5,45	39x53,5x81
0000CO5050DUB	white, with grey pedal and red cover	50	1	0,123	5,45	39x53,5x81
0000CO5050DUC	white, with grey pedal and yellow cover	50	1	0,123	5,45	39x53,5x81
0000CO5050DUF	white, with grey pedal and green cover	50	1	0,123	5,45	39x53,5x81
0000CO5050DUU	white, with grey pedal and grey cover	50	1	0,123	5,45	39x53,5x81



Advised bag size: 70x110 cm

OYSTER - wall mounted plastic bin 50 L without pedal and without cover



REF.	NOTES	PCK	VOLUME (m³)	GROSS WEIGHT (kg)
0000CO5150D		1	0,123	4,6
0000CO5150U		1	0,123	4,6

Advised bag size: 70x110 cm

Plastic cover for Oyster bin



REF.	NOTES
P190060A	
P190060B	
P190060C	
P190060D	
P190060F	
P190060U	





BINS FOR SEPARATE WASTE COLLECTION

SANITARY BINS

WASTE TROLLEYS

PAPER HOLDERS

Plastic bag stretcher for Oyster bin



REF.	NOTES
SLP015000001D	<input type="checkbox"/>
SLP015000001U	<input checked="" type="checkbox"/>

Plastic key for Oyster bin



REF.	NOTES
SLP015000009H	

Shock absorbing piston for a soft closing of the cover



REF.	NOTES
P190908U	



Plastic pedal for Oyster bin



REF.	NOTES
SLP015000004D	<input type="checkbox"/>
SLP015000004U	<input checked="" type="checkbox"/>

Plastic rod for wall mounting Oyster bin



REF.	NOTES
P190061H	

Plastic pedal rod for Oyster bin



REF.	NOTES
SLP015000007H	



BINS FOR SEPARATE WASTE COLLECTION

SANITARY BINS

WASTE TROLLEYS

PAPER HOLDERS

Double-sided tape set for Oyster wall mounting

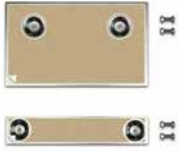

REF.	NOTES
0000SM00600	

Painted display stand support complete with screws for Oyster bin



REF.	NOTES	PCK	VOLUME (m³)	GROSS WEIGHT (kg)
V190062		3	0,21	27,19

Handy bins

HANDY - bin 70 L with drain plug, wheels, bag stretcher, grip and cover



REF.	NOTES	PCK	VOLUME (m³)	GROSS WEIGHT (kg)	SIZE (cm) ↓ ↓ ↓
0000CO6170E		2	0,293	12,8	51,5x56x86

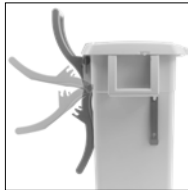

Advised bag size: 75x110 cm

HANDY - bin 70 L with drain plug, wheels and bag stretcher



REF.	NOTES	PCK	VOLUME (m³)	GROSS WEIGHT (kg)	SIZE (cm) ↓ ↓ ↓
P391070E	with push-bar	2	0,293	11,41	51,5x56x86
P291070E	without push-bar	2	0,293	10,6	37x56x71



Advised bag size: 75x110 cm



BINS FOR SEPARATE WASTE COLLECTION

SANITARY BINS

WASTE TROLLEYS

PAPER HOLDERS

Cover set complete with rubber lace, cage for deodorant pills and screws



REF.	NOTES
P290068E	

Assembling kit to fix Handy bin to Alpha vertical frame



REF.	NOTES
0000SM00610	



The **Polaris Delux** bin 90 L is handy and can be placed everywhere; it is made **in compliance with the HACCP rules**: therefore, it is the ideal bin for kitchens, restaurants, canteens and all the environments associated with food processing activities. It is completely made of polypropylene, strong and round-shaped for an easy cleaning.

It can be equipped with shock absorbing pistons "Hush System" for a soft closing of the cover and with several accessories, such as a multipurpose plastic basket, a paper-roll holder and several different hooks to carry small cleaning tools.



The door has a 250° opening that allows to take out and empty the bag in a practical way reducing the operator's efforts.



It is equipped with an ergonomic push-bar and plastic wheels ø 125 mm to handle the bin better and easier.



The cover has a 90° opening that helps the operator while emptying the bin.



Complete with shock absorbing pistons, two plastic hooks to fix the bag and with a cage for deodorant or disinfectant pills.

Polaris Delux bins

POLARIS DELUX - beige plastic bin 90 L with front door, pedal, push-bar, wheels ø 125 mm and coloured cover, equipped with shock-absorbing pistons



REF.	NOTES	PCK	VOLUME (m³)	GROSS WEIGHT (kg)	SIZE (cm) ↓ ↓ ↓
0000CO3090I	with beige cover	2	0,223	18,79	49x52x93
0000CO3091I	with blue cover	2	0,223	18,79	49x52x93
0000CO3092I	with red cover	2	0,223	18,79	49x52x93
0000CO3093I	with yellow cover	2	0,223	18,79	49x52x93
0000CO3094I	with green cover	2	0,223	18,79	49x52x93

With surcharge available in single package - To order it single packed, just add 0001 before the letters in the standard reference. Es: 0001CO3090I - Advised bag size: 80x110 cm

POLARIS DELUX - beige plastic bin 90 L with bag holder 2x45 L, front door, pedal, push-bar, wheels ø 125 mm and coloured cover, equipped with shock-absorbing pistons



REF.	NOTES	PCK	VOLUME (m³)	GROSS WEIGHT (kg)	SIZE (cm) ↓ ↓ ↓
0000CO3190I	with beige cover	2	0,223	18,79	49x52x93
0000CO3191I	with blue cover	2	0,223	18,79	49x52x93
0000CO3192I	with red cover	2	0,223	18,79	49x52x93
0000CO3193I	with yellow cover	2	0,223	18,79	49x52x93
0000CO3194I	with green cover	2	0,223	18,79	49x52x93

With surcharge available in single package - To order it single packed, just add 0001 before the letters in the standard reference. Es: 0001CO3190I - Advised bags size: 70x110 cm



BINS FOR SEPARATE WASTE COLLECTION

SANITARY BINS

WASTE TROLLEYS

PAPER HOLDERS

Polaris bins

POLARIS - beige plastic bin 90 L with pedal, push-bar, wheels Ø 100 mm and coloured cover



REF.	NOTES	PCK	VOLUME (m³)	GROSS WEIGHT (kg)	SIZE (cm) ↓ ↓ ↓
0000C02090I	with beige cover	2	0,216	15,06	49x52x93
0000C02091I	with blue cover	2	0,216	15,06	49x52x93
0000C02092I	with red cover	2	0,216	15,06	49x52x93
0000C02093I	with yellow cover	2	0,216	15,06	49x52x93
0000C02094I	with green cover	2	0,216	15,06	49x52x93



With surcharge available in single package - To order it single packed, just add 0001 before the letters in the standard reference. Ex: 0001C02090I - Advised bag size: 80x110 cm

POLARIS - beige plastic bin 90 L with bag holder 2x45 L, pedal, push-bar, wheels ø 100 mm and coloured cover



REF.	NOTES	PCK	VOLUME (m³)	GROSS WEIGHT (kg)	SIZE (cm) ↓ ↓ ↓
0000C02190I	with beige cover	2	0,216	15,56	49x52x93
0000C02191I	with blue cover	2	0,216	15,56	49x52x93
0000C02192I	with red cover	2	0,216	15,56	49x52x93
0000C02193I	with yellow cover	2	0,216	15,56	49x52x93
0000C02194I	with green cover	2	0,216	15,56	49x52x93



With surcharge available in single package - To order it single packed, just add 0001 before the letters in the standard reference. Es: 0001C02190I - Advised bags size 70x110 cm

Components for Polaris and Polaris Delux

Beige Polaris plastic bin 90 L without cover, with pedal, push-grip and wheels Ø 100 mm



REF.	NOTES	PCK	VOLUME (m³)	GROSS WEIGHT (kg)
P190915I		2	0,216	13,48



Advised bag size: 80x110 cm



BINS FOR SEPARATE WASTE COLLECTION

SANITARY BINS

WASTE TROLLEYS

PAPER HOLDERS

Plastic cover for Polaris Delux 90 L



REF.	NOTES	PCK	VOLUME (m³)	GROSS WEIGHT (kg)
P290914A		20	0,258	19,9
P290914B		20	0,258	19,9
P290914C		20	0,258	19,9
P290914F		20	0,258	19,9
P290914I		20	0,258	19,9



Please, require also no. 2 shock absorbing pistons art. P190908U for a perfect soft closing

Plastic cover for Polaris 90 L



REF.	NOTES	PCK	VOLUME (m³)	GROSS WEIGHT (kg)
P190914A		20	0,258	19,74
P190914B		20	0,258	19,74
P190914C		20	0,258	19,74
P190914F		20	0,258	19,74
P190914I		20	0,258	19,38



Please, require also no. 2 shock absorbing pistons art. P190908U for a perfect soft closing

Plastic cover for Polaris and Polaris Delux 2x45 L



REF.	NOTES
P390914A	
P390914B	
P390914C	
P390914F	
P390914I	



Please, require also no. 2 shock absorbing pistons art. P190908U for a perfect soft closing

Accessories for Polaris and Polaris Delux

Shock absorbing piston for a soft closing of the cover



REF.	NOTES
P190908U	





BINS FOR SEPARATE WASTE COLLECTION

SANITARY BINS

WASTE TROLLEYS

PAPER HOLDERS

Sticky label 11x11,5 cm with image for separate waste collection



REF.	NOTES
701421	with image "metal"
701422	with image "paper"
701424	with design "organic waste"
701425	with image "plastic"
701426	with image "glass"
701428	with design "mixed waste"

Sticky label 11x11,5 cm with image and writing for separate waste collection



REF.	NOTES
701431	with image and writing "metalli"
701432	with image and writing "carta"
701440	with design and writing "organic waste"
701435	with image and writing "plastica"
701436	with image and writing "vetro"
701439	with design and writing "mixed waste"

Plastic handle holder for Polaris and Polaris Delux bins



REF.	NOTES
0000SM0131I	

Plastic hook for Polaris and Polaris Delux bins



REF.	NOTES
0000SM0132I	

FLIP - handle holder with rubber roll for Polaris and Polaris Delux bins



REF.	NOTES
0000SM00111	



Plastic side basket set for Polaris and Polaris Delux bins



REF.	NOTES
0000SM0133I	

BINS FOR SEPARATE WASTE COLLECTION

SANITARY BINS

WASTE TROLLEYS

PAPER HOLDERS

Set of paper holder with cover and 3 hooks for Polaris and Polaris Delux bins



REF.	NOTES
P225006I	

Plastic containers 120 and 240 liters

 Polyethylene bin with cover, bag stretcher and axial wheels ϕ 200 mm

REF.	NOTES	CAPACITY (L)	PCK	VOLUME (m ³)	GROSS WEIGHT (kg)	SIZE (cm) ↓ ↓ ↓
0000CO1120D	<input type="checkbox"/>	120	1	0,291	13,62	55x48x93
0000CO1120F	<input checked="" type="checkbox"/>	120	1	0,291	13,62	55x48x93
0000CO1240D	<input type="checkbox"/>	240	1	0,567	18,5	73x58x107
0000CO1240F	<input checked="" type="checkbox"/>	240	1	0,567	18,5	73x58x107

 Polyethylene bin with cover, bag stretcher, pedal and axial wheels ϕ 200 mm

REF.	NOTES	CAPACITY (L)	PCK	VOLUME (m ³)	GROSS WEIGHT (kg)	SIZE (cm) ↓ ↓ ↓
0000CO2120D	<input type="checkbox"/>	120	1	0,291	12,72	55x48x93
0000CO2120F	<input checked="" type="checkbox"/>	120	1	0,291	12,72	55x48x93
0000CO2240D	<input type="checkbox"/>	240	1	0,567	21,3	73x58x107
0000CO2240F	<input checked="" type="checkbox"/>	240	1	0,567	21,3	73x58x107



BINS FOR SEPARATE WASTE COLLECTION

SANITARY BINS

WASTE TROLLEYS

PAPER HOLDERS

Desy is a bin for lady's sanitary towels with a modern design, that fulfils the specific needs of hygiene.
Delivered already assembled and packed one piece per box.

Also available with the **10 l capacity**, in the free-standing version and in the wall version for narrow bathrooms.



Desy 10 L bin



Desy 10 L wall mounted bin



Cover opening with a peculiar design that inhibits the sight of the content and prevents the release of any odour.



It is equipped with bag stretcher and cage for deodorant pills.

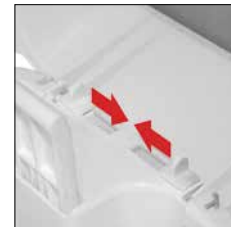

It has a particular fixing system of the cover which allows to remove it very easily and quickly, if necessary.

Desy bins

DESY - plastic bin 10 L with cover and pedal for sanitary towels



REF.	NOTES	CAPACITY (L)	PCK	VOLUME (m³)	GROSS WEIGHT (kg)	SIZE (cm)
0000C02010DE		10	1	0,034	1,69	35,7x18x43,5



Advised bag size: 45x55 cm

DESY - plastic bin 10 L for sanitary towels with cover, pedal and fixing kit for wall



REF.	NOTES	CAPACITY (L)	PCK	VOLUME (m³)	GROSS WEIGHT (kg)	SIZE (cm)
0000C02910DE		10	1	0,034	2,25	35,7x18x43,5



Advised bag size: 45x55 cm



BINS FOR SEPARATE WASTE COLLECTION

SANITARY BINS

WASTE TROLLEYS

PAPER HOLDERS

DESY - plastic bin with cover and pedal for sanitary towels



REF.	NOTES	CAPACITY (L)	PCK	VOLUME (m³)	GROSS WEIGHT (kg)	SIZE (cm) ↓ ↓ ↓
0000CO2017DE		17	1	0,049	1,9	42x20x54
0000CO2023DE		23	1	0,06	2,24	42x20x65



Advised bag size: 50x60 cm for 17 lt and 55x65 cm for 23 lt

Rilsan coated wall-fixing support for Sally and Desy bins



REF.	NOTES
R2180400	only for Sally-Desy 17 L

Kiddy bins

KIDDY - plastic bin 23 L with cover and pedal for kids' diapers



REF.	NOTES	PCK	VOLUME (m³)	GROSS WEIGHT (kg)	SIZE (cm) ↓ ↓ ↓
0000CO3023D		1	0,069	2,57	42x20x67

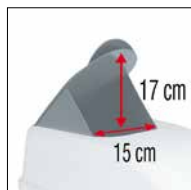

Ideal for nurseries and kindergartens - Advised bag size: 55x65 cm

Patty for Lady bins

PATTY FOR LADY - plastic bin 25 L with cover and pedal for sanitary towels



REF.	NOTES	PCK	VOLUME (m³)	GROSS WEIGHT (kg)	SIZE (cm) ↓ ↓ ↓
0000CO2025D		1	0,042	2,58	32x34x52



Advised bag size: 50x60 cm



Delta: high capacity and space-saving size in just one trolley

Delta plastic bag holding trolley has a rounded and smooth design and is easy to clean.

It is equipped with a handy and ergonomic push-bar and a wide foot-operated pedal opening of the cover.

Maximum flexibility: available also in the version 2x60 L and 1x60L + 2x30 L for a much more efficient waste collection.

The bag holding trolley is now available in the **Delta Compact** version, ideal for the small and narrow spaces thanks to its space-saving size.

Delta and **Delta Compact** are available in grey and can be equipped with a multipurpose carry basket and useful hooks and handle holders.

DELTA



DELTA COMPACT

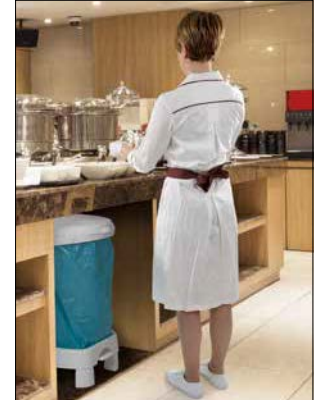

Version 2x60 L

Version 1x60 L + 2x30 L

Versions with 4 wheels

Versions with 2 wheels and 2 feet

Delta bag holding trolleys

DELTA - white plastic bag holding trolley 120 L complete with 4 wheels, pedal and coloured cover



REF.	NOTES	PCK	VOLUME (m³)	GROSS WEIGHT (kg)	SIZE (cm) ↓ ↓ ↓
0000CO4120D	with white cover	2	0,207	14,2	64x50x99
0000CO4121D	with blue cover	2	0,207	14,2	64x50x99
0000CO4122D	with red cover	2	0,207	14,2	64x50x99
0000CO4123D	with yellow cover	2	0,207	14,2	64x50x99
0000CO4124D	with green cover	2	0,207	14,2	64x50x99

With surcharge available in single package - To order the single bin, simply add the prefix 0001 on the front of the standard code. E.g. 0001CO4120D - Advised bag size: 75x110 cm

DELTA - white plastic bag holding trolley 120 L complete with 2 wheels, 2 feet, pedal and coloured cover



REF.	NOTES	PCK	VOLUME (m³)	GROSS WEIGHT (kg)	SIZE (cm) ↓ ↓ ↓
0000CO4220D	with white cover	2	0,207	13,9	64x50x99
0000CO4221D	with blue cover	2	0,207	13,9	64x50x99
0000CO4222D	with red cover	2	0,207	13,9	64x50x99
0000CO4223D	with yellow cover	2	0,207	13,9	64x50x99
0000CO4224D	with green cover	2	0,207	13,9	64x50x99

With surcharge available in single package - To order the single bin, simply add the prefix 0001 on the front of the standard code. E.g. 0001CO4220D - Advised bag size: 75x110 cm



BINS FOR SEPARATE WASTE COLLECTION

SANITARY BINS

WASTE TROLLEYS

PAPER HOLDERS

DELTA - white plastic bag holding trolley 120 L complete with 4 wheels, pedal and cover



REF.	NOTES	PCK	VOLUME (m³)	GROSS WEIGHT (kg)	SIZE (cm) ↓ ↓ ↓
2000CO4120D	with 2x60 L bag holder	2	0,207	15,1	64x50x99
3000CO4120D	with 1x60 L + 2x30 L bag holder	2	0,207	15,1	64x50x99



Advised bags size: 75x110 cm

DELTA - white plastic bag holding trolley 120 L complete with 2 wheels, 2 feet, pedal and cover



REF.	NOTES	PCK	VOLUME (m³)	GROSS WEIGHT (kg)	SIZE (cm) ↓ ↓ ↓
2000CO4220D	with 2x60 L bag holder	2	0,207	14,9	64x50x99
3000CO4220D	with 1x60 L + 2x30 L bag holder	2	0,207	14,8	64x50x99



Advised bags size: 75x110 cm

DELTA COMPACT - white plastic bag holder, with 2 wheels and 2 feet, pedal and coloured cover



REF.	NOTES	PCK	VOLUME (m³)	GROSS WEIGHT (kg)	SIZE (cm) ↓ ↓ ↓
0003CO4220D		2	0,148	12,11	64x50x80



Ideal to be placed under worktops - Advised bag size: 75x110 cm



BINS FOR SEPARATE WASTE COLLECTION

SANITARY BINS

WASTE TROLLEYS

PAPER HOLDERS

Components for Delta trolleys

Plastic base with 2 wheels ø 125 mm for Delta trolley



REF.	NOTES
P290981D	for trolleys with 4 wheels
P290989D	for trolleys with wheels and feet

Aluminium rod (connecting pedal/cover) with plastic closing connections for Delta trolley



REF.	NOTES
P290977D	for Delta
P290979D	for Delta Compact

Plastic bag holder for Delta trolley



REF.	NOTES
P290978D	120 L
P390986D	2x60 L
P390987D	60 L + 2x30 L

Plastic cover for Delta bag holding trolley



REF.	NOTES
P290976A	
P290976B	
P290976C	
P290976D	
P290976F	



Please, require also no. 2 shock absorbing pistons art. P190908U for a perfect soft closing

Set of two feet (right and left) for Delta trolley



REF.	NOTES
P190974D	



BINS FOR SEPARATE WASTE COLLECTION

SANITARY BINS

WASTE TROLLEYS

PAPER HOLDERS

Plastic pedal for Delta trolley



REF.	NOTES
P190973D	

Pedal rod for Delta trolley



REF.	NOTES
P190972D	

Accessories for Delta bag holding trolleys

Shock absorbing piston for a soft closing of the cover



REF.	NOTES
P190908U	



Plastic carry basket for Delta bag holding trolley



REF.	NOTES
P190975N	



"X" trolleys

Chromed X-trolley with square bag holder 120 L and pirouetting wheels ø 80 mm



REF.	NOTES	PCK	VOLUME (m³)	GROSS WEIGHT (kg)	SIZE (cm) ↓ ↓ ↓
8042		5	0,302	34,73	62x60x103

Chromed X-trolley with removable square bag holder 120 L and pirouetting wheels ø 80 mm



REF.	NOTES	PCK	VOLUME (m³)	GROSS WEIGHT (kg)	SIZE (cm) ↓ ↓ ↓
8042/1		2	0,16	13,93	62x60x103

ROBBY - painted X-trolley with round bag holder 120 L, elastic and pirouetting wheels ø 80 mm



REF.	NOTES	PCK	VOLUME (m³)	GROSS WEIGHT (kg)	SIZE (cm) ↓ ↓ ↓
8045A		5	0,302	33,23	58x56x102
8045B		5	0,302	33,23	58x56x102
00018045A		1	0,072	7,36	58x56x102
00018045B		1	0,072	7,36	58x56x102

Chromed X-trolley with round bag holder 120 L, elastic and pirouetting wheels ø 80 mm



REF.	NOTES	PCK	VOLUME (m³)	GROSS WEIGHT (kg)	SIZE (cm) ↓ ↓ ↓
8070		5	0,302	35,23	58x56x102
00018070		1	0,072	7,76	58x56x102



BINS FOR SEPARATE WASTE COLLECTION

SANITARY BINS

WASTE TROLLEYS

PAPER HOLDERS

Chromed X-trolley with round bag holder 120 L, elastic, plastic cover, pedal set and pirouetting wheels ø 80 mm



REF.	NOTES	PCK	VOLUME (m³)	GROSS WEIGHT (kg)	SIZE (cm) ↓ ↓ ↓
8075		3	0,21	24,23	58x56x102
00018075		1	0,072	8,76	58x56x102

Trolleys for outdoor use

Chromed bag holding trolley for outdoor use with round bag holder 120 L, elastic and wheels ø 175 mm



REF.	NOTES	PCK	VOLUME (m³)	GROSS WEIGHT (kg)	SIZE (cm) ↓ ↓ ↓
8076		2	0,177	12,7	58x58x102

It is possible to fix the chromed basket 50x20x13 cm art. 8205/2

Chromed bag holding trolley for outdoor use with round bag holder 120 L, elastic, wheels ø 175 mm, plastic cover and pedal



REF.	NOTES	PCK	VOLUME (m³)	GROSS WEIGHT (kg)	SIZE (cm) ↓ ↓ ↓
8077		2	0,177	14,36	58x58x102

Chromed bag holding trolley for outdoor use with round bag holder 70 L, elastic, wheels ø 175 mm, plastic cover and pedal



REF.	NOTES	PCK	VOLUME (m³)	GROSS WEIGHT (kg)	SIZE (cm) ↓ ↓ ↓
8077/1		2	0,177	12,7	58x48x102

Available while stocks last



BINS FOR SEPARATE WASTE COLLECTION

SANITARY BINS

WASTE TROLLEYS

PAPER HOLDERS

Rilsan bag holding trolley for outdoor use with round bag holder 120 L, elastic, wheels \varnothing 175 mm, plastic cover and pedal



REF.	NOTES	PCK	VOLUME (m ³)	GROSS WEIGHT (kg)	SIZE (cm) ↓ ↓ ↓
R8377		2	0,244	13,93	57x52x91

Painted bag holding trolley complete with three stairs climbing wheels for street cleaning



REF.	NOTES	PCK	VOLUME (m ³)	GROSS WEIGHT (kg)
7450/2		1	0,567	20,41



It can be equipped with a 25 L bin art. 8169/1 - It can be used with plastic bin 120 L art. 0000C01120F

Galvanized bag holding trolley complete with wheels \varnothing 260 mm for street cleaning



REF.	NOTES	PCK	VOLUME (m ³)	GROSS WEIGHT (kg)	SIZE (cm) ↓ ↓ ↓
8050		1	0,567	15,11	77x68x114



It is used with bin 120 L art. 0000C01120F - It can be equipped with plastic bin 25 L art. 8169/1

Galvanized bag holding trolley with bag holder 120 L and wheels \varnothing 260 mm for street cleaning



REF.	NOTES	PCK	VOLUME (m ³)	GROSS WEIGHT (kg)	SIZE (cm) ↓ ↓ ↓
8040		1	0,567	18,41	77x68x114



It can be equipped with plastic bin 25 L art. 8169/1



BINS FOR SEPARATE WASTE COLLECTION

SANITARY BINS

WASTE TROLLEYS

PAPER HOLDERS

Painted bag holding trolley complete with wheels ø 260 mm for street cleaning



REF.	NOTES	PCK	VOLUME (m³)	GROSS WEIGHT (kg)	SIZE (cm) ↓ ↓ ↓
8450		1	0,567	15,7	77x68x114



It can be equipped with a 25 L bin art. 8169/1 - It can be used with plastic bin 120 L art. 0000CO1120F

Painted bag holding trolley complete with bag holder 120 L and wheels ø 260 mm for street cleaning



REF.	NOTES	PCK	VOLUME (m³)	GROSS WEIGHT (kg)	SIZE (cm) ↓ ↓ ↓
8440		1	0,567	18,41	77x68x114



It can be equipped with plastic bin 25 L art. 8169/1

TREND - free standing bag holder 70 L with elastic and yellow plastic cover



REF.	NOTES	PCK	VOLUME (m³)	GROSS WEIGHT (kg)
8174C	height 72 cm	5	0,246	14,4

TREND - free standing bag holder 70 L with elastic, yellow plastic cover, wheels ø 35 mm and bag support



REF.	NOTES	PCK	VOLUME (m³)	GROSS WEIGHT (kg)
8175	height 76 cm	5	0,246	17,9



BINS FOR SEPARATE WASTE COLLECTION

SANITARY BINS

WASTE TROLLEYS

PAPER HOLDERS

Green bag holder for outdoor use, without cover

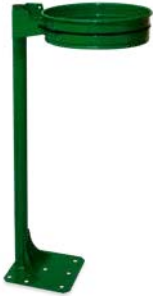

REF.	NOTES	PCK	VOLUME (m³)	GROSS WEIGHT (kg)
8191F	height 99 cm	2	0,2	14,39

Multi-sort waste separation trolleys

Chromed trolley tube Ø 25 cm with double bag holder 2x120 L and pirouetting wheels Ø 100 mm



REF.	NOTES	PCK	VOLUME (m³)	GROSS WEIGHT (kg)	SIZE (cm) ↓ ↓ ↓
8049		2	0,302	17,35	67x60x110

TEDDY 8083 - chromed trolley



REF.	PCK	VOLUME (m³)	GROSS WEIGHT (kg)	SIZE (cm) ↓ ↓ ↓
8083X	1	0,191	10,48	82x51x105

0000SM00115U	FLIP - handle holder with rubber roll and snap closure fitting tubes Ø 22 mm	1 pc.
3657	Chromed bag holder 120 L for Teddy trolleys	2 pcs
8203/2	Chromed vertical frame for Teddy trolleys	1 pc.
8611U	Plastic flanges with screws for vertical frame fixing	2 pcs
C8201CL	Chromed base 47x80 cm with wheels Ø 100 mm and bumpers for trolleys art. 8080X and 8083X	1 pc.

⚠ ACCESSORIES TO BE ORDERED SEPARATELY

3639A	Blue plastic cover for bag holder 120 L art. 3657-R2060010- I2060010 and R2060060	1 pc.
3639B	Red plastic cover for bag holder 120 L art. 3657-R2060010- I2060010 and R2060060	1 pc.
3650A	Blue plastic-coated bag 73x97 cm, maximum capacity 120 L	1 pc.
3650B	Red plastified bag 73x97,5 cm, capacity 120 L	1 pc.

ECOLOGY 3100 - chromed trolley



REF.	PCK	VOLUME (m³)	GROSS WEIGHT (kg)	SIZE (cm) ↓ ↓ ↓
3100	1	0,291	27,62	84x58x110

3604	Chromed vertical frame for Jumbo trolley	2 pcs
3647	Chromed basket holder for Ecology trolleys	1 pc.
3667A	PICK-UP - blue plastic bin 45 L without wheels, complete with cover and screen printed plastic plate with image "paper"	1 pc.
3667B	PICK-UP - red plastic bin 45 L without wheels, complete with cover and screen printed plastic plate with image "metal"	1 pc.
3667C	PICK-UP - yellow plastic bin 45 L without wheels, complete with cover and screen printed plastic plate with image "plastic"	1 pc.
3667F	PICK-UP - green plastic bin 45 L without wheels, complete with cover and screen printed plastic plate with image "glass"	1 pc.
C3629CL	Chromed base 77x51 cm with wheels Ø 100 mm and bumpers for Jumbo Tank, Master and Quick trolleys	1 pc.

Components for chromed waste trolleys

Bag fixing elastic



REF.	NOTES
8054	for trolleys art.8045,8070,8075,8076,8077,8077/1,R8377,8040 and 8440
8054/1	for Trend and laundry trolleys

Pedal set with rods



REF.	NOTES
8074	for Robby trolley art. 8075
8079	for free standing trolleys art. 8076 and 8077
8079/1	for free standing trolley art. 8077/1

Plastic tray for the base of the trolleys art. 8049, Teddy 8090X-8098X and Panda



REF.	NOTES	SIZE (cm) ↓ ↓ ↓
8227		39,5x59x2,5

Galvanized bag holder 120 L with elastic for street cleaning's trolley



REF.	NOTES
Z2060104	galvanized
V2060104F	painted green

Container holder 25 lt for street cleaning trolley



REF.	NOTES
Z2060103	galvanized
V2060103F	painted green

Plastic clip for bag fixing



REF.	NOTES
8220/1	

Plastic bag fixing clip



REF.	NOTES
8220A	

For the Teddy and Ecology trolley components and accessories see the multipurpose trolley range



BINS FOR SEPARATE WASTE COLLECTION

SANITARY BINS

WASTE TROLLEYS

PAPER HOLDERS

Accessories for chromed waste trolleys

Round plastic cover with hinges fitting trolleys art. 8045, 8070, 8075, 8076, 8077, 8077/1, R8377, 8040 and 8440



REF.	NOTES
8055B	

Square plastic cover with hinges fitting "X" trolley art. 8042



REF.	NOTES
8056DB	

Round plastic cover with hinges fitting bag holding trolley Trend



REF.	NOTES
8400A	
8400B	
8400C	

Round cover for bag holder for outdoor use complete with screws



REF.	NOTES
8092F	

Plastic coated basket for trolleys art. 8042, 8042/1, 8045, 8070 and 8075



REF.	NOTES	SIZE (cm)
8053		↓ ↓ ↓ 41,5x22,5x21

Chromed basket for Teddy and art. 8076 trolleys



REF.	NOTES	SIZE (cm)
8205/2		↓ ↓ ↓ 50x20x13

For the Teddy and Ecology trolley components and accessories see the multipurpose trolley range



BINS FOR SEPARATE WASTE COLLECTION

SANITARY BINS

WASTE TROLLEYS

PAPER HOLDERS

Chromed frame for basket art. 8205 for "X" trolleys art. 8042, 8042/1, 8045 and 8070



REF.	NOTES
8071	

Chromed basket fitting vertical frame art. 8071



REF.	NOTES	SIZE (cm) ↓ ↓ ↓
8205		43,5x26x16

Chromed paper holder for trolleys art. 8045, 8070, 8042 and 8042/1



REF.	NOTES
8072	

Plastified side panel with pockets fitting trolleys art. 8042, 8042/1, 8045, 8070, 8075 and 8043



REF.	NOTES	SIZE (cm) ↓ ↓ ↓
8058		48x74

Ash-tray box for trolleys art. 8042/1



REF.	NOTES
8073B	

Wheel ø 80 mm with turning plate complete with screws



REF.	NOTES
23011300	To be applied to street cleaning trolleys

For the Teddy and Ecology trolley components and accessories see the multipurpose trolley range



BINS FOR SEPARATE WASTE COLLECTION

SANITARY BINS

WASTE TROLLEYS

PAPER HOLDERS

Alpha trolleys

ALPHA 1102 - plastic trolley



ALPHA 2107 - plastic trolley



REF.	PCK	VOLUME (m³)	GROSS WEIGHT (kg)	SIZE (cm) ↓ ↓ ↓
0000MA1102U00	1	0,177	14,21	97x58x102

0000SM00163	Set of T-shaped dark grey closing plugs for vertical frames (6 pcs)	1 pc.
P059011U	Short base with wheels ø 100 mm	1 pc.
P165000U	Base extension for Alpha trolleys and for the bag supporting plastic plate of the Morgan Hotel Elegance trolleys	1 pc.
P2031103U	Vertical frame with reinforcement, 1 smooth side + 1 side for T-plugs, complete with screws	1 pc.
P8161110U	120l waste bag holder, female fitting, with dustpan hook and handle clip	1 pc.
P8161111U	120l waste bag holder, male fitting, with dustpan hook and handle clip	1 pc.

⚠ ACCESSORIES TO BE ORDERED SEPARATELY

3650A	Blue plastic-coated bag 73x97 cm, maximum capacity 120 L	1 pc.
3650B	Red plastified bag 73x97,5 cm, capacity 120 L	1 pc.
P291918A	Blue cover for bag holder 120 L	1 pc.
P291918B	Red cover for bag holder 120 L	1 pc.

ON REQUEST, WITH SURCHARGE

	Rubber wheels ø 125 mm TROLLEY REF. 0000MA1302U00		Wheels ø 125 mm TROLLEY REF. 0000MA1602U00		Foldable bag holder 120 L TROLLEY REF. 0300MA1102U00
--	--	--	---	--	---



REF.	PCK	VOLUME (m³)	GROSS WEIGHT (kg)	SIZE (cm) ↓ ↓ ↓
0500MA2107U00	1	0,224	19,05	126x58x102

Trolley dimensions with closed foldable bag holder 72x58x145 cm

0000SM00165	Set of T-shaped light grey closing plugs for vertical frames (6 pcs)	2 pcs
P059011U	Short base with wheels ø 100 mm	1 pc.
P165000U	Base extension for Alpha trolleys and for the bag supporting plastic plate of the Morgan Hotel Elegance trolleys	1 pc.
P175000U	Supporting plastic plate for Alpha trolleys	1 pc.
P2039903E	Vertical frame, 1 side with slides + 1 side for T-plugs, complete with screws and plugs	2 pcs
P8161113U	Folding 120l waste bag holder, with bag retaining hooks, dustpan hook, handle clip, screws and plugs	2 pcs
P8169903U	Central bag holder 150 L (female-female version)	1 pc.

⚠ ACCESSORIES TO BE ORDERED SEPARATELY

0000AT0190E	Grey plastified bag 79x96 cm, capacity 150 L	1 pc.
3650A	Blue plastic-coated bag 73x97 cm, maximum capacity 120 L	1 pc.
3650B	Red plastified bag 73x97,5 cm, capacity 120 L	1 pc.
P291918A	Blue cover for bag holder 120 L	1 pc.
P291918B	Red cover for bag holder 120 L	1 pc.
P2919943U	Cover for central bag holder 150 L	1 pc.

ON REQUEST, WITH SURCHARGE

	Rubber wheels ø 125 mm TROLLEY REF. 0500MA2307U00		Wheels ø 125 mm TROLLEY REF. 0500MA2607U00
--	--	--	---



BINS FOR SEPARATE WASTE COLLECTION

SANITARY BINS

WASTE TROLLEYS

PAPER HOLDERS

ALPHA 5143 - plastic trolley



ALPHA 0901006 - plastic trolley



REF.	PCK	VOLUME (m³)	GROSS WEIGHT (kg)	SIZE (cm) ↓ ↓ ↓
0300MA5143U00	1	0,261	18,15	133x58x102

Trolley dimensions with closed foldable bag holder 100x58x145 cm

0000SM00165	Set of T-shaped light grey closing plugs for vertical frames (6 pcs)	2 pcs
P066011U	Long base with wheels ø 100 mm	1 pc.
P175000U	Supporting plastic plate for Alpha trolleys	1 pc.
P2039903E	Vertical frame, 1 side with slides + 1 side for T-plugs, complete with screws and plugs	2 pcs
P8161111U	120l waste bag holder, male fitting, with dustpan hook and handle clip	1 pc.
P8161113U	Folding 120l waste bag holder, with bag retaining hooks, dustpan hook, handle clip, screws and plugs	1 pc.
P8169903U	Central bag holder 150 L (female-female version)	1 pc.

ACCESSORIES TO BE ORDERED SEPARATELY

0000AT0190E	Grey plastified bag 79x96 cm, capacity 150 L	1 pc.
3650A	Blue plastic-coated bag 73x97 cm, maximum capacity 120 L	1 pc.
3650B	Red plastified bag 73x97,5 cm, capacity 120 L	1 pc.
P291918A	Blue cover for bag holder 120 L	1 pc.
P291918B	Red cover for bag holder 120 L	1 pc.
P2919943U	Cover for central bag holder 150 L	1 pc.

ON REQUEST, WITH SURCHARGE

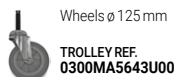

REF.	PCK	VOLUME (m³)	GROSS WEIGHT (kg)	SIZE (cm) ↓ ↓ ↓
MA0901006U000	1	0,27	22,27	146x58x102

Trolley dimensions with closed foldable bag holder 101x58x145 cm

0000SM00165	Set of T-shaped light grey closing plugs for vertical frames (6 pcs)	2 pcs
P066011U	Long base with wheels ø 100 mm	1 pc.
P175000U	Supporting plastic plate for Alpha trolleys	2 pcs
P2039903E	Vertical frame, 1 side with slides + 1 side for T-plugs, complete with screws and plugs	2 pcs
P8161113U	Folding 120l waste bag holder, with bag retaining hooks, dustpan hook, handle clip, screws and plugs	2 pcs
P8169906U	Set of 2 bag holders 150 L complete with screws and plugs	1 pc.

ACCESSORIES TO BE ORDERED SEPARATELY

0000AT0190E	Grey plastified bag 79x96 cm, capacity 150 L	2 pcs
3650A	Blue plastic-coated bag 73x97 cm, maximum capacity 120 L	1 pc.
3650B	Red plastified bag 73x97,5 cm, capacity 120 L	1 pc.
P291918A	Blue cover for bag holder 120 L	1 pc.
P291918B	Red cover for bag holder 120 L	1 pc.
P2919943U	Cover for central bag holder 150 L	2 pcs

ON REQUEST, WITH SURCHARGE





BINS FOR SEPARATE WASTE COLLECTION

SANITARY BINS

WASTE TROLLEYS

PAPER HOLDERS

ALPHA 7103 - plastic trolley



ALPHA 8125 - plastic trolley



REF.	PCK	VOLUME (m³)	GROSS WEIGHT (kg)	SIZE (cm) ↓ ↓ ↓
0000MA7103U00	1	0,261	21,85	105x58x102

0000SM00165	Set of T-shaped light grey closing plugs for vertical frames (6 pcs)	1 pc.
P066011U	Long base with wheels ø 100 mm	1 pc.
P2039903E	Vertical frame, 1 side with slides + 1 side for T-plugs, complete with screws and plugs	1 pc.
P2909912U	Divider for bag holder 150 L	2 pcs
P2909946A	Blue cover for bag holder 150 L with check list holder	1 pc.
P2909946B	Red cover for bag holder 150 L with check list holder	1 pc.
P3059953E	Fixed side wall with fixing pins	4 pcs
P3909952E	Door with fixing pins for bag holder	2 pcs
P8169900U	150l waste bag holder, female fitting, with 2 Uni-Move clips, 2 long supports with sign hook, 2 pistons, screws and plugs for Alpha 7103 trolley	1 pc.
P8169901U	150l waste bag holder, male fitting, with 2 Uni-Move clips, 2 long supports with sign hook, 2 pistons, screws and plugs for Alpha 7103 trolley	1 pc.

⚠ ACCESSORIES TO BE ORDERED SEPARATELY

0000AT0160A	Plastified bag 56x92 cm, capacity 80 L, blu	2 pcs
0000AT0160B	Plastified bag 56x92 cm, capacity 80 L, red	2 pcs
P2909915U	Pedal kit for Alpha trolleys with large, mini or supporting plate, 150 lt bag holder and ø 100 mm wheels	1 pc.

ON REQUEST, WITH SURCHARGE

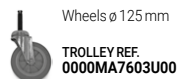

REF.	PCK	VOLUME (m³)	GROSS WEIGHT (kg)	SIZE (cm) ↓ ↓ ↓
1000MA8125U00	1	0,372	30,77	146x58x102

0000SM00165	Set of T-shaped light grey closing plugs for vertical frames (6 pcs)	2 pcs
P066011U	Long base with wheels ø 100 mm	1 pc.
P2039903E	Vertical frame, 1 side with slides + 1 side for T-plugs, complete with screws and plugs	2 pcs
P2909912U	Divider for bag holder 150 L	3 pcs
P2909946A	Blue cover for bag holder 150 L with check list holder	1 pc.
P2909946B	Red cover for bag holder 150 L with check list holder	1 pc.
P2919943U	Cover for central bag holder 150 L	1 pc.
P3059953E	Fixed side wall with fixing pins	5 pcs
P3059954E	Right door with fixing pins	1 pc.
P3909952E	Door with fixing pins for bag holder	2 pcs
P515010U	Supporting plate with 2 wheels ø 100 mm and 2 blocking pins	1 pc.
P8169903U	Central bag holder 150 L (female-female version)	1 pc.
P8169905U	150-liter bag holder for Alpha standard and 90-liter for Alpha with Split system, male version, with hooks, pistons, screws and plugs	2 pcs

⚠ ACCESSORIES TO BE ORDERED SEPARATELY

0000AT0160A	Plastified bag 56x92 cm, capacity 80 L, blu	2 pcs
0000AT0160B	Plastified bag 56x92 cm, capacity 80 L, red	3 pcs
0000AT0160E	Grey plastified bag 56x92 cm, capacity 80 L	1 pc.
P2909915U	Pedal kit for Alpha trolleys with large, mini or supporting plate, 150 lt bag holder and ø 100 mm wheels	2 pcs

ON REQUEST, WITH SURCHARGE

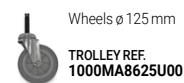

BINS FOR SEPARATE WASTE COLLECTION

SANITARY BINS

WASTE TROLLEYS

PAPER HOLDERS

ALPHA 0901005 - plastic trolley



REF.	PCK	VOLUME (m³)	GROSS WEIGHT (kg)	SIZE (cm) ↓ ↓ ↓
MA0901005U002	1	0,372	30,77	146x58x102

AVAILABLE TO ORDER

0000SM00165	Set of T-shaped light grey closing plugs for vertical frames (6 pcs)	2 pcs
P066011U	Long base with wheels ø 100 mm	1 pc.
P2039903E	Vertical frame, 1 side with slides + 1 side for T-plugs, complete with screws and plugs	2 pcs
P2909946A	Blue cover for bag holder 150 L with check list holder	1 pc.
P2909946B	Red cover for bag holder 150 L with check list holder	1 pc.
P2919943U	Cover for central bag holder 150 L	1 pc.
P3119953E	Fixed side wall with "plastic" design, with fixing pins	2 pcs
P3129953E	Fixed side wall with "glass" design, with fixing pins	1 pc.
P3129954E	Right door with "glass" design, with fixing pins	1 pc.
P3139953E	Fixed side wall with "paper" design, with fixing pins	2 pcs
P3909952E	Door with fixing pins for bag holder	2 pcs
P515010U	Supporting plate with 2 wheels ø 100 mm and 2 blocking pins	1 pc.
P8169903U	Central bag holder 150 L (female-female version)	1 pc.
P8169905U	150-liter bag holder for Alpha standard and 90-liter for Alpha with Split system, male version, with hooks, pistons, screws and plugs	2 pcs

ACCESSORIES TO BE ORDERED SEPARATELY

0000AT0190A	Blue plastified bag 150 L, 79x96 cm	1 pc.
0000AT0190B	Red plastified bag 150 L, 79x96cm	1 pc.
0000AT0190E	Grey plastified bag 79x96 cm, capacity 150 L	1 pc.
P2909915U	Pedal kit for Alpha trolleys with large, mini or supporting plate, 150 lt bag holder and ø 100 mm wheels	2 pcs

ON REQUEST, WITH SURCHARGE

Rubber wheels ø 125 mm TROLLEY REF. MA0903005U002	Wheels ø 125 mm TROLLEY REF. MA0906005U002	Bag holder with adjustable push-grip TROLLEY REF. MA0901055U002
--	---	--

ALPHA 0901019 - plastic trolley



REF.	PCK	VOLUME (m³)	GROSS WEIGHT (kg)	SIZE (cm) ↓ ↓ ↓
MA0901019U000	1	0,488	35,64	194x58x102

0000SM00165	Set of T-shaped light grey closing plugs for vertical frames (6 pcs)	2 pcs
P066011U	Long base with wheels ø 100 mm	1 pc.
P2039903E	Vertical frame, 1 side with slides + 1 side for T-plugs, complete with screws and plugs	2 pcs
P2039904E	Vertical frame, 2 sides with slides, complete with screws and plugs	1 pc.
P2909912U	Divider for bag holder 150 L	4 pcs
P2909946A	Blue cover for bag holder 150 L with check list holder	1 pc.
P2909946B	Red cover for bag holder 150 L with check list holder	1 pc.
P2919943U	Cover for central bag holder 150 L	2 pcs
P3059953E	Fixed side wall with fixing pins	6 pcs
P3059954E	Right door with fixing pins	1 pc.
P3059974E	Left door with fixing pins	1 pc.
P3909952E	Door with fixing pins for bag holder	2 pcs
P515010U	Supporting plate with 2 wheels ø 100 mm and 2 blocking pins	2 pcs
P8169903U	Central bag holder 150 L (female-female version)	1 pc.
P8169904U	Central bag holder 150 L (male-female version) complete with screws and plugs	1 pc.
P8169905U	150-liter bag holder for Alpha standard and 90-liter for Alpha with Split system, male version, with hooks, pistons, screws and plugs	2 pcs

ACCESSORIES TO BE ORDERED SEPARATELY

0000AT0160A	Plastified bag 56x92 cm, capacity 80 L, blu	2 pcs
0000AT0160B	Plastified bag 56x92 cm, capacity 80 L, red	4 pcs
0000AT0160E	Grey plastified bag 56x92 cm, capacity 80 L	2 pcs
P2909915U	Pedal kit for Alpha trolleys with large, mini or supporting plate, 150 lt bag holder and ø 100 mm wheels	2 pcs

ON REQUEST, WITH SURCHARGE

Rubber wheels ø 125 mm TROLLEY REF. MA0903019U000	Wheels ø 125 mm TROLLEY REF. MA0906019U000	Bag holder with adjustable push-grip TROLLEY REF. MA0901069U000
--	---	--



BINS FOR SEPARATE WASTE COLLECTION

SANITARY BINS

WASTE TROLLEYS

PAPER HOLDERS

Morgan trolleys

MORGAN 1010 - plastic trolley



MORGAN 1030 - plastic trolley



REF.	PCK	VOLUME (m³)	GROSS WEIGHT (kg)	SIZE (cm) ↓ ↓ ↓
0000MP1010A	1	0,191	12,96	93x57x104

0000SM00115U	FLIP - handle holder with rubber roll and snap closure fitting tubes Ø 22 mm	1 pc.
P202001A	Short plastic base with wheels ø 100 mm and bumpers for Morgan trolley	1 pc.
R1030010	Rilsan coated vertical frame complete with screws for Morgan trolley	1 pc.
R2060010	Rilsan coated bag holder 120 L with bag-stretchers for Morgan trolley	2 pcs

⚠ ACCESSORIES TO BE ORDERED SEPARATELY

3639A	Blue plastic cover for bag holder 120 L art. 3657-R2060010-I2060010 and R2060060	2 pcs
3650A	Blue plastic-coated bag 73x97 cm, maximum capacity 120 L	2 pcs

ON REQUEST, WITH SURCHARGE



REF.	PCK	VOLUME (m³)	GROSS WEIGHT (kg)	SIZE (cm) ↓ ↓ ↓
0000MP1030U	1	0,191	9,82	102x57x104

0000SM00115U	FLIP - handle holder with rubber roll and snap closure fitting tubes Ø 22 mm	1 pc.
P202001U	Short plastic base with wheels ø 100 mm and bumpers for Morgan trolley	1 pc.
P816010U	Plastic bag holder 120 L with push-bar, bag-stretchers and reinforcements	2 pcs
R1030147	Rilsan coated vertical frame with double connection for Morgan trolley art. 0000MP1030U	1 pc.

⚠ ACCESSORIES TO BE ORDERED SEPARATELY

3650A	Blue plastic-coated bag 73x97 cm, maximum capacity 120 L	1 pc.
3650B	Red plastified bag 73x97,5 cm, capacity 120 L	1 pc.
P291918A	Blue cover for bag holder 120 L	1 pc.
P291918B	Red cover for bag holder 120 L	1 pc.

ON REQUEST, WITH SURCHARGE





BINS FOR SEPARATE WASTE COLLECTION

SANITARY BINS

WASTE TROLLEYS

PAPER HOLDERS

Painted metal paper holders

Painted white metal wall paper holder



REF.	NOTES	PCK	VOLUME (m³)	GROSS WEIGHT (kg)	SIZE (cm) ↓ ↓ ↓
8171		10	0,115	19,13	21x41x34

For maximum size rolls ø 32x29 cm

Painted white metal standing paper holder on wheels



REF.	NOTES	PCK	VOLUME (m³)	GROSS WEIGHT (kg)	SIZE (cm) ↓ ↓ ↓
8172		5	0,19	18,56	62x49x103

For maximum size rolls ø 35x36 cm

Plastic paper holders

Closed plastic wall paper holder



REF.	NOTES	PCK	VOLUME (m³)	GROSS WEIGHT (kg)	SIZE (cm) ↓ ↓ ↓
8571		1	0,048	2	31,5x36x34

Closed plastic standing paper holder on wheels



REF.	NOTES	PCK	VOLUME (m³)	GROSS WEIGHT (kg)	SIZE (cm) ↓ ↓ ↓
8272		4	0,153	9,06	51,5x47x91

For maximum size rolls ø 42x42cm



BINS FOR SEPARATE WASTE COLLECTION

SANITARY BINS

WASTE TROLLEYS

PAPER HOLDERS

Paper holders

Painted bag holder 120 L complete with basket (39x12x10 cm), clip with spring and wheels ø 175 mm



REF.	NOTES	PCK	VOLUME (m³)	GROSS WEIGHT (kg)	SIZE (cm) ↓ ↓ ↓
8167		2	0,244	12,87	44x45x95



Housekeeping trolleys

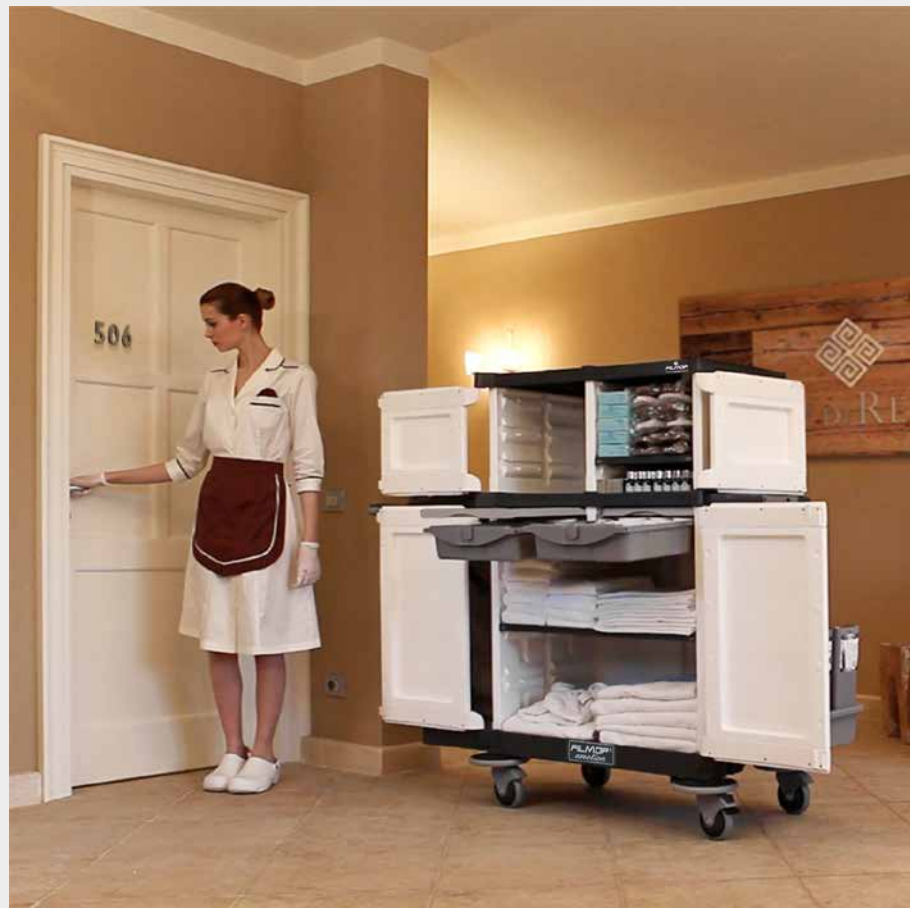

Morgan Hotel Elegance

Alpha Hotel

Emotion

KeepHotel

Trolleys for laundry
collection

Silver





MORGAN HOTEL ELEGANCE

ALPHA HOTEL

EMOTION

KEEPHOTEL

TROLLEYS FOR LAUNDRY COLLECTION

SILVER



The **Morgan Hotel Elegance** line is elegant, smart, simple and fits any environment, satisfying any cleaning need and request in hotels.

Characterized by Rilsan coated vertical frames, rich and elegant wooden shelves made of beech, brown plastified panels, easy to remove and periodically clean.

The trolley can be equipped with a wide and complete range of accessories ideal to meet any cleaning need: it can be used for the change of towels and linen, for the collection of dirty towels and linen by means of the specific trolleys for laundry collection, for the cleaning of rooms and bathrooms and for waste collection.

Light series

Light range service trolleys feature a modern design, and are light and easy to control.

The whole range also offers utmost capacity.



Some details about the Morgan Hotel Elegance line:



Plastic sliding drawer 10 and 22 L with locking key for guest amenities



Handy plastic baskets



Bins and bagholder for the separate waste collection



Bathrobe holder kit



It is standard equipped with the useful door stopper (cod. P130001Q).

Morgan Hotel Trolleys can be used with several wet mopping systems:



Top-Down® system



Bucket 22 L and its special mop



Master Lux bucket



Unilav wet mopping system

Accessories



Roll-up front covering: handy and safe



Coupling device to connect the laundry trolley with dirty linen to the Morgan Hotel trolley



MORGAN HOTEL ELEGANCE

ALPHA HOTEL

EMOTION

KEEPHOTEL

TROLLEYS FOR LAUNDRY
COLLECTION

SILVER

Light series

MORGAN HOTEL LIGHT 4374 - trolley with wooden shelves

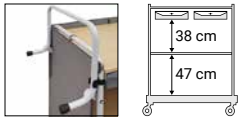

REF.	PCK	VOLUME (m³)	GROSS WEIGHT (kg)	SIZE (cm)
0000HP4374U	1	0,342	39,25	165x55x130

Recommended for 14-16 rooms - Max. load capacity 30 kg/shelf

0000AT0185E	90l self-standing bag with strape tape system, grey	2 pcs
I1900050	Galvanized steel rod 102 cm to fix the back panel	1 pc.
L0220013	Wooden shelf 85, 5x46 cm, for line 800	1 pc.
L5220013	Wooden shelf 85, 5x46 cm with slots for two plastic drawers, for line 800	1 pc.
P1229909U	Plastic sliding drawer 10 L without locking key	2 pcs
P202051U	Big base with ø 125 mm wheels and ø 130 mm bumpers	1 pc.
P514000U	Bag support shelf with 125mm ø castor and 130mm ø bumpers	2 pcs
Q1400011E	Full 3-sided reinforced plastic-coated cloth back, grey	1 pc.
R1230110	Rilsan coated reinforcing rod for Morgan Hotel trolley, 81 cm	2 pcs
R2030161	Rilsan vertical frame with 2 bag holder retaining clips	2 pcs
R2060081	Rilsan 90l bag holder for Morgan Hotel Light trolleys	2 pcs

ON REQUEST, WITH SURCHARGE



MORGAN HOTEL LIGHT 4373 - trolley with wooden shelves

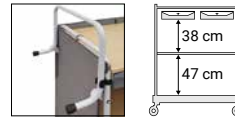

REF.	PCK	VOLUME (m³)	GROSS WEIGHT (kg)	SIZE (cm)
0000HP4373U	1	0,295	34,44	135x55x130

Recommended for 14-16 rooms - Max. load capacity 30 kg/shelf

0000AT0185E	90l self-standing bag with strape tape system, grey	1 pc.
I1900050	Galvanized steel rod 102 cm to fix the back panel	1 pc.
L0220013	Wooden shelf 85, 5x46 cm, for line 800	1 pc.
L5220013	Wooden shelf 85, 5x46 cm with slots for two plastic drawers, for line 800	1 pc.
P1229909U	Plastic sliding drawer 10 L without locking key	2 pcs
P202051U	Big base with ø 125 mm wheels and ø 130 mm bumpers	1 pc.
P514000U	Bag support shelf with 125mm ø castor and 130mm ø bumpers	1 pc.
Q1400011E	Full 3-sided reinforced plastic-coated cloth back, grey	1 pc.
R1230110	Rilsan coated reinforcing rod for Morgan Hotel trolley, 81 cm	2 pcs
R2030161	Rilsan vertical frame with 2 bag holder retaining clips	2 pcs
R2060081	Rilsan 90l bag holder for Morgan Hotel Light trolleys	1 pc.

ON REQUEST, WITH SURCHARGE

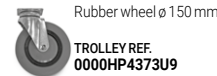

Housekeeping trolleys



MORGAN HOTEL ELEGANCE

ALPHA HOTEL

EMOTION

KEEPHOTEL

TROLLEYS FOR LAUNDRY
COLLECTION

SILVER

MORGAN HOTEL LIGHT 4274 - trolley with wooden shelves

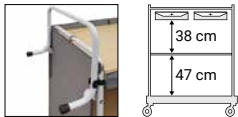

REF.	PCK	VOLUME (m³)	GROSS WEIGHT (kg)	SIZE (cm)
0000HP4274U	1	0,295	36,64	155x55x130

Recommended for 14-16 rooms - Max. load capacity 30 kg/shelf - Trolley dimensions with closed bag holders 114x55x144 cm

0000AT0185E	90l self-standing bag with strape tape system, grey	2 pcs
I1900050	Galvanized steel rod 102 cm to fix the back panel	1 pc.
L0220013	Wooden shelf 85,5x46 cm, for line 800	1 pc.
L5220013	Wooden shelf 85,5x46 cm with slots for two plastic drawers, for line 800	1 pc.
P1229909U	Plastic sliding drawer 10 L without locking key	2 pcs
P202051U	Big base with ø 125 mm wheels and ø 130 mm bumpers	1 pc.
Q1400011E	Full 3-sided reinforced plastic-coated cloth back, grey	1 pc.
R1230110	Rilsan coated reinforcing rod for Morgan Hotel trolley, 81 cm	2 pcs
R2030161	Rilsan vertical frame with 2 bag holder retaining clips	2 pcs
R2060081	Rilsan 90l bag holder for Morgan Hotel Light trolleys	2 pcs

ON REQUEST, WITH SURCHARGE



MORGAN HOTEL LIGHT 4273 - trolley with wooden shelves

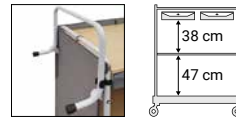

REF.	PCK	VOLUME (m³)	GROSS WEIGHT (kg)	SIZE (cm)
0000HP4273U	1	0,295	32	128x55x130

Recommended for 14-16 rooms - Max. load capacity 30 kg/shelf

0000AT0185E	90l self-standing bag with strape tape system, grey	1 pc.
I1900050	Galvanized steel rod 102 cm to fix the back panel	1 pc.
L0220013	Wooden shelf 85,5x46 cm, for line 800	1 pc.
L5220013	Wooden shelf 85,5x46 cm with slots for two plastic drawers, for line 800	1 pc.
P1229909U	Plastic sliding drawer 10 L without locking key	2 pcs
P202051U	Big base with ø 125 mm wheels and ø 130 mm bumpers	1 pc.
Q1400011E	Full 3-sided reinforced plastic-coated cloth back, grey	1 pc.
R1230110	Rilsan coated reinforcing rod for Morgan Hotel trolley, 81 cm	2 pcs
R2030161	Rilsan vertical frame with 2 bag holder retaining clips	2 pcs
R2060081	Rilsan 90l bag holder for Morgan Hotel Light trolleys	1 pc.

ON REQUEST, WITH SURCHARGE

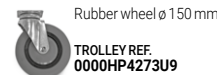



MORGAN HOTEL ELEGANCE

ALPHA HOTEL

EMOTION

KEEPHOTEL

TROLLEYS FOR LAUNDRY COLLECTION

SILVER

Line 600

MORGAN HOTEL 600 - trolley with wooden shelves

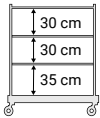

REF.	PCK	VOLUME (m³)	GROSS WEIGHT (kg)	SIZE (cm) ↓ ↓ ↓
0000HP3300U	1	0,307	26,54	88x49x130

Advised for 10-12 room service - Max. load capacity 30 kg/shelf

.P130001Q	Door stopper made of plastic and rubber	1 pc.
L0220014	Wooden shelf, 72,5x46 cm, for line 600	3 pcs
P202008U	Short base with wheels ø 125 mm	1 pc.
R1030122	Rilsan coated vertical frame, 111 cm high, for Hotel trolleys 600 and 800	2 pcs
R1230111	Rilsan coated reinforcing rod, 68 cm, for Morgan Hotel trolley	2 pcs

ON REQUEST, WITH SURCHARGE



MORGAN HOTEL 611 - trolley with wooden shelves

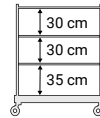

REF.	PCK	VOLUME (m³)	GROSS WEIGHT (kg)	SIZE (cm) ↓ ↓ ↓
0000HP3301U	1	0,295	29,14	88x49x130

Advised for 10-12 room service - Max. load capacity 30 kg/shelf

.P130001Q	Door stopper made of plastic and rubber	1 pc.
I1900050	Galvanized steel rod 102 cm to fix the back panel	1 pc.
L0220014	Wooden shelf, 72,5x46 cm, for line 600	3 pcs
P202008U	Short base with wheels ø 125 mm	1 pc.
Q1400030G	Plastified and reinforced back and side panels (3 parts) for Line 600, brown and grey	1 pc.
R1030122	Rilsan coated vertical frame, 111 cm high, for Hotel trolleys 600 and 800	2 pcs
R1230111	Rilsan coated reinforcing rod, 68 cm, for Morgan Hotel trolley	2 pcs

ON REQUEST, WITH SURCHARGE

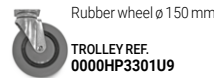



MORGAN HOTEL ELEGANCE

ALPHA HOTEL

EMOTION

KEEPHOTEL

TROLLEYS FOR LAUNDRY
COLLECTION

SILVER

MORGAN HOTEL 612 - trolley with wooden shelves

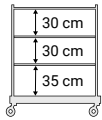

MORGAN HOTEL 613 - trolley with wooden shelves

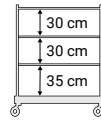

REF.	PCK	VOLUME (m³)	GROSS WEIGHT (kg)	SIZE (cm) ↓ ↓ ↓
0000HP3302U	1	0,295	33,54	126x52x130

Advised for 10-12 room service - Max. load capacity 30 kg/shelf

.P130001Q	Door stopper made of plastic and rubber	1 pc.
I1900050	Galvanized steel rod 102 cm to fix the back panel	1 pc.
L0220014	Wooden shelf, 72,5x46 cm, for line 600	3 pcs
P202008U	Short base with wheels ø 125 mm	1 pc.
P314001U	Supporting plastic plate with wheel ø 125 mm	1 pc.
P816010U	Plastic bag holder 120 L with push-bar, bag-stretchers and reinforcements	1 pc.
Q1400030G	Plastified and reinforced back and side panels (3 parts) for Line 600, brown and grey	1 pc.
R1030122	Rilsan coated vertical frame, 111 cm high, for Hotel trolleys 600 and 800	2 pcs
R1230111	Rilsan coated reinforcing rod, 68 cm, for Morgan Hotel trolley	2 pcs

⚠ ACCESSORIES TO BE ORDERED SEPARATELY

8057A	Polyester bag capacity 150L, white with blue stripe	1 pc.
-------	---	-------

ON REQUEST, WITH SURCHARGE



REF.	PCK	VOLUME (m³)	GROSS WEIGHT (kg)	SIZE (cm) ↓ ↓ ↓
0000HP3303U	1	0,307	37,94	166x52x130

Advised for 10-12 room service - Max. load capacity 30 kg/shelf

.P130001Q	Door stopper made of plastic and rubber	1 pc.
I1900050	Galvanized steel rod 102 cm to fix the back panel	1 pc.
L0220014	Wooden shelf, 72,5x46 cm, for line 600	3 pcs
P202008U	Short base with wheels ø 125 mm	1 pc.
P314001U	Supporting plastic plate with wheel ø 125 mm	2 pcs
P816010U	Plastic bag holder 120 L with push-bar, bag-stretchers and reinforcements	2 pcs
Q1400030G	Plastified and reinforced back and side panels (3 parts) for Line 600, brown and grey	1 pc.
R1030122	Rilsan coated vertical frame, 111 cm high, for Hotel trolleys 600 and 800	2 pcs
R1230111	Rilsan coated reinforcing rod, 68 cm, for Morgan Hotel trolley	2 pcs

⚠ ACCESSORIES TO BE ORDERED SEPARATELY

8057A	Polyester bag capacity 150L, white with blue stripe	2 pcs
-------	---	-------

ON REQUEST, WITH SURCHARGE





MORGAN HOTEL ELEGANCE

ALPHA HOTEL

EMOTION

KEEPHOTEL

TROLLEYS FOR LAUNDRY
COLLECTION

SILVER

Line 800

MORGAN HOTEL 614 - trolley with wooden shelves

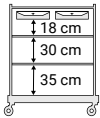

REF.	PCK	VOLUME (m³)	GROSS WEIGHT (kg)	SIZE (cm) ↓ ↓ ↓
0000HP4304U	1	0,307	39,42	166x52x130

Advised for 10-12 room service - Max. load capacity 30 kg/shelf

.P130001Q	Door stopper made of plastic and rubber	1 pc.
I1900050	Galvanized steel rod 102 cm to fix the back panel	1 pc.
L0220014	Wooden shelf, 72,5x46 cm, for line 600	2 pcs
L4220014	Wooden shelf 72,5x46 cm with slots for one plastic sliding drawer, for line 600	1 pc.
P202008U	Short base with wheels ø 125 mm	1 pc.
P2229909U	Plastic sliding drawer 10 L with lock	1 pc.
P314001U	Supporting plastic plate with wheel ø 125 mm	2 pcs
P816010U	Plastic bag holder 120 L with push-bar, bag-stretchers and reinforcements	2 pcs
Q1400030G	Plastified and reinforced back and side panels (3 parts) for Line 600, brown and grey	1 pc.
R1030122	Rilsan coated vertical frame, 111 cm high, for Hotel trolleys 600 and 800	2 pcs
R1230111	Rilsan coated reinforcing rod, 68 cm, for Morgan Hotel trolley	2 pcs

⚠ ACCESSORIES TO BE ORDERED SEPARATELY

8057A	Polyester bag capacity 150L, white with blue stripe	2 pcs
-------	---	-------

ON REQUEST, WITH SURCHARGE

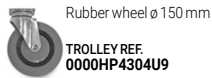

MORGAN HOTEL 800 - trolley with wooden shelves

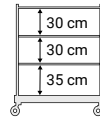

REF.	PCK	VOLUME (m³)	GROSS WEIGHT (kg)	SIZE (cm) ↓ ↓ ↓
0000HP3360U	1	0,295	29,64	102x49x130

Recommended for 14-16 rooms - Max. load capacity 30 kg/shelf

.P130001Q	Door stopper made of plastic and rubber	1 pc.
L0220013	Wooden shelf 85,5x46 cm, for line 800	3 pcs
P202058U	Long base with wheels ø 125 mm	1 pc.
R1030122	Rilsan coated vertical frame, 111 cm high, for Hotel trolleys 600 and 800	2 pcs
R1230110	Rilsan coated reinforcing rod for Morgan Hotel trolley, 81 cm	2 pcs

ON REQUEST, WITH SURCHARGE

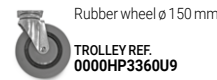



MORGAN HOTEL 811 - trolley with wooden shelves

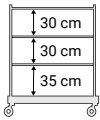

REF.	PCK	VOLUME (m³)	GROSS WEIGHT (kg)	SIZE (cm)
0000HP3361U	1	0,307	32,44	102x49x130

Recommended for 14-16 rooms - Max. load capacity 30 kg/shelf

.P130001Q	Door stopper made of plastic and rubber	1 pc.
I1900050	Galvanized steel rod 102 cm to fix the back panel	1 pc.
L0220013	Wooden shelf 85, 5x46 cm, for line 800	3 pcs
P202058U	Long base with wheels ø 125 mm	1 pc.
Q1400010G	Plastified and reinforced back and side panels (3 parts) for Line 800, brown and grey	1 pc.
R1030122	Rilsan coated vertical frame, 111 cm high, for Hotel trolleys 600 and 800	2 pcs
R1230110	Rilsan coated reinforcing rod for Morgan Hotel trolley, 81 cm	2 pcs

ON REQUEST, WITH SURCHARGE



MORGAN HOTEL 812 - trolley with wooden shelves

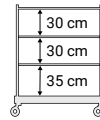

REF.	PCK	VOLUME (m³)	GROSS WEIGHT (kg)	SIZE (cm)
0000HP3362U	1	0,295	36,84	140x52x130

Recommended for 14-16 rooms - Max. load capacity 30 kg/shelf

.P130001Q	Door stopper made of plastic and rubber	1 pc.
I1900050	Galvanized steel rod 102 cm to fix the back panel	1 pc.
L0220013	Wooden shelf 85, 5x46 cm, for line 800	3 pcs
P202058U	Long base with wheels ø 125 mm	1 pc.
P314001U	Supporting plastic plate with wheel ø 125 mm	1 pc.
P816010U	Plastic bag holder 120 L with push-bar, bag-stretchers and reinforcements	1 pc.
Q1400010G	Plastified and reinforced back and side panels (3 parts) for Line 800, brown and grey	1 pc.
R1030122	Rilsan coated vertical frame, 111 cm high, for Hotel trolleys 600 and 800	2 pcs
R1230110	Rilsan coated reinforcing rod for Morgan Hotel trolley, 81 cm	2 pcs

ACCESSORIES TO BE ORDERED SEPARATELY

8057A	Polyester bag capacity 150L, white with blue stripe	1 pc.
-------	---	-------

ON REQUEST, WITH SURCHARGE

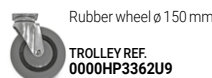



MORGAN HOTEL 813 - trolley with wooden shelves

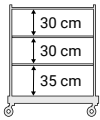

REF.	PCK	VOLUME (m³)	GROSS WEIGHT (kg)	SIZE (cm)
0000HP3363U	1	0,307	41,24	178x52x130

Recommended for 14-16 rooms - Max. load capacity 30 kg/shelf

.P130001Q	Door stopper made of plastic and rubber	1 pc.
I1900050	Galvanized steel rod 102 cm to fix the back panel	1 pc.
L0220013	Wooden shelf 85, 5x46 cm, for line 800	3 pcs
P202058U	Long base with wheels ø 125 mm	1 pc.
P314001U	Supporting plastic plate with wheel ø 125 mm	2 pcs
P816010U	Plastic bag holder 120 L with push-bar, bag-stretchers and reinforcements	2 pcs
Q1400010G	Plastified and reinforced back and side panels (3 parts) for Line 800, brown and grey	1 pc.
R1030122	Rilsan coated vertical frame, 111 cm high, for Hotel trolleys 600 and 800	2 pcs
R1230110	Rilsan coated reinforcing rod for Morgan Hotel trolley, 81 cm	2 pcs

⚠ ACCESSORIES TO BE ORDERED SEPARATELY

8057A	Polyester bag capacity 150L, white with blue stripe	2 pcs
-------	---	-------

ON REQUEST, WITH SURCHARGE



MORGAN HOTEL 814 - trolley with wooden shelves

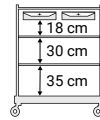

REF.	PCK	VOLUME (m³)	GROSS WEIGHT (kg)	SIZE (cm)
0000HP4364U	1	0,295	44,14	177x52x130

Recommended for 14-16 rooms - Max. load capacity 30 kg/shelf

.P130001Q	Door stopper made of plastic and rubber	1 pc.
I1900050	Galvanized steel rod 102 cm to fix the back panel	1 pc.
L0220013	Wooden shelf 85, 5x46 cm, for line 800	2 pcs
L5220013	Wooden shelf 85,5x46 cm with slots for two plastic drawers, for line 800	1 pc.
P202058U	Long base with wheels ø 125 mm	1 pc.
P2229909U	Plastic sliding drawer 10 L with lock	2 pcs
P314001U	Supporting plastic plate with wheel ø 125 mm	2 pcs
P816010U	Plastic bag holder 120 L with push-bar, bag-stretchers and reinforcements	2 pcs
Q1400010G	Plastified and reinforced back and side panels (3 parts) for Line 800, brown and grey	1 pc.
R1030122	Rilsan coated vertical frame, 111 cm high, for Hotel trolleys 600 and 800	2 pcs
R1230110	Rilsan coated reinforcing rod for Morgan Hotel trolley, 81 cm	2 pcs

⚠ ACCESSORIES TO BE ORDERED SEPARATELY

8057A	Polyester bag capacity 150L, white with blue stripe	2 pcs
-------	---	-------

ON REQUEST, WITH SURCHARGE

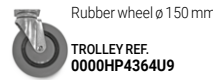

Housekeeping trolleys



MORGAN HOTEL ELEGANCE

ALPHA HOTEL

EMOTION

KEEPHOTEL

TROLLEYS FOR LAUNDRY
COLLECTION

SILVER

MORGAN HOTEL 815 - trolley with wooden shelves

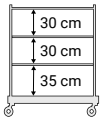

MORGAN HOTEL 816 - trolley with wooden shelves

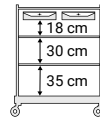

REF.	PCK	VOLUME (m³)	GROSS WEIGHT (kg)	SIZE (cm) ↓ ↓ ↓
0000HP3365U	1	0,295	33,44	140x52x130

Recommended for 14-16 rooms - Max. load capacity 30 kg/shelf

.P130001Q	Door stopper made of plastic and rubber	1 pc.
I1900050	Galvanized steel rod 102 cm to fix the back panel	1 pc.
L0220013	Wooden shelf 85, 5x46 cm, for line 800	3 pcs
P202058U	Long base with wheels ø 125 mm	1 pc.
P314001U	Supporting plastic plate with wheel ø 125 mm	1 pc.
P816010U	Plastic bag holder 120 L with push-bar, bag-stretchers and reinforcements	1 pc.
Q0400070G	Plastified and reinforced side panel with pockets, brown and grey	1 pc.
Q1400050G	Plastified and reinforced smooth side panel (2 pcs), brown and grey	1 pc.
Q1400090G	Plastified and reinforced panel for Line 800, brown and grey	1 pc.
R1030122	Rilsan coated vertical frame, 111 cm high, for Hotel trolleys 600 and 800	2 pcs
R1230110	Rilsan coated reinforcing rod for Morgan Hotel trolley, 81 cm	2 pcs

⚠ ACCESSORIES TO BE ORDERED SEPARATELY

8057A	Polyester bag capacity 150L, white with blue stripe	1 pc.
-------	---	-------

ON REQUEST, WITH SURCHARGE



REF.	PCK	VOLUME (m³)	GROSS WEIGHT (kg)	SIZE (cm) ↓ ↓ ↓
0000HP4366U	1	0,295	35,64	140x52x130

Recommended for 14-16 rooms - Max. load capacity 30 kg/shelf

.P130001Q	Door stopper made of plastic and rubber	1 pc.
I1900050	Galvanized steel rod 102 cm to fix the back panel	1 pc.
L0220013	Wooden shelf 85, 5x46 cm, for line 800	2 pcs
L5220013	Wooden shelf 85,5x46 cm with slots for two plastic drawers, for line 800	1 pc.
P202058U	Long base with wheels ø 125 mm	1 pc.
P2229909U	Plastic sliding drawer 10 L with lock	2 pcs
P314001U	Supporting plastic plate with wheel ø 125 mm	1 pc.
P816010U	Plastic bag holder 120 L with push-bar, bag-stretchers and reinforcements	1 pc.
Q0400070G	Plastified and reinforced side panel with pockets, brown and grey	1 pc.
Q1400050G	Plastified and reinforced smooth side panel (2 pcs), brown and grey	1 pc.
Q1400090G	Plastified and reinforced panel for Line 800, brown and grey	1 pc.
R1030122	Rilsan coated vertical frame, 111 cm high, for Hotel trolleys 600 and 800	2 pcs
R1230110	Rilsan coated reinforcing rod for Morgan Hotel trolley, 81 cm	2 pcs

⚠ ACCESSORIES TO BE ORDERED SEPARATELY

8057A	Polyester bag capacity 150L, white with blue stripe	1 pc.
-------	---	-------

ON REQUEST, WITH SURCHARGE

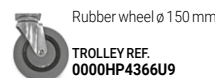



MORGAN HOTEL 817 - trolley with wooden shelves



REF.	PCK	VOLUME (m³)	GROSS WEIGHT (kg)	SIZE (cm)
0000HP3367U	1	0,295	34,14	140x52x130

Recommended for 14-16 rooms - Max. load capacity 30 kg/shelf

.P130001Q	Door stopper made of plastic and rubber	1 pc.
I1900050	Galvanized steel rod 102 cm to fix the back panel	1 pc.
L0220013	Wooden shelf 85, 5x46 cm, for line 800	3 pcs
P202058U	Long base with wheels ø 125 mm	1 pc.
P314001U	Supporting plastic plate with wheel ø 125 mm	1 pc.
P816010U	Plastic bag holder 120 L with push-bar, bag-stretchers and reinforcements	1 pc.
Q0400075G	Plastic-coated reinforced brown side panel with glove compartment, dispenser, bottles and bucket 4 lt.	1 pc.
Q1400050G	Plastified and reinforced smooth side panel (2 pcs), brown and grey	1 pc.
Q1400090G	Plastified and reinforced panel for Line 800, brown and grey	1 pc.
R1030122	Rilsan coated vertical frame, 111 cm high, for Hotel trolleys 600 and 800	2 pcs
R1230110	Rilsan coated reinforcing rod for Morgan Hotel trolley, 81 cm	2 pcs

⚠ ACCESSORIES TO BE ORDERED SEPARATELY

8057A	Polyester bag capacity 150L, white with blue stripe	1 pc.
-------	---	-------

ON REQUEST, WITH SURCHARGE



MORGAN HOTEL 818 - trolley with wooden shelves



REF.	PCK	VOLUME (m³)	GROSS WEIGHT (kg)	SIZE (cm)
0000HP4368U	1	0,295	36,34	140x52x130

Recommended for 14-16 rooms - Max. load capacity 30 kg/shelf

.P130001Q	Door stopper made of plastic and rubber	1 pc.
I1900050	Galvanized steel rod 102 cm to fix the back panel	1 pc.
L0220013	Wooden shelf 85, 5x46 cm, for line 800	2 pcs
L5220013	Wooden shelf 85,5x46 cm with slots for two plastic drawers, for line 800	1 pc.
P202058U	Long base with wheels ø 125 mm	1 pc.
P2229909U	Plastic sliding drawer 10 L with lock	2 pcs
P314001U	Supporting plastic plate with wheel ø 125 mm	1 pc.
P816010U	Plastic bag holder 120 L with push-bar, bag-stretchers and reinforcements	1 pc.
Q0400075G	Plastic-coated reinforced brown side panel with glove compartment, dispenser, bottles and bucket 4 lt.	1 pc.
Q1400050G	Plastified and reinforced smooth side panel (2 pcs), brown and grey	1 pc.
Q1400090G	Plastified and reinforced panel for Line 800, brown and grey	1 pc.
R1030122	Rilsan coated vertical frame, 111 cm high, for Hotel trolleys 600 and 800	2 pcs
R1230110	Rilsan coated reinforcing rod for Morgan Hotel trolley, 81 cm	2 pcs

⚠ ACCESSORIES TO BE ORDERED SEPARATELY

8057A	Polyester bag capacity 150L, white with blue stripe	1 pc.
-------	---	-------

ON REQUEST, WITH SURCHARGE

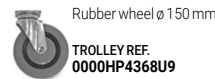



MORGAN HOTEL ELEGANCE

ALPHA HOTEL

EMOTION

KEEPHOTEL

TROLLEYS FOR LAUNDRY
COLLECTION

SILVER

MORGAN HOTEL 851 - trolley with wooden shelves

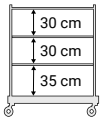

MORGAN HOTEL 852 - trolley with wooden shelves

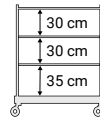

REF.	PCK	VOLUME (m³)	GROSS WEIGHT (kg)	SIZE (cm) ↓ ↓ ↓
0000HP3341U	1	0,295	26,6	104x52x130

Suggested for 6 to 8 rooms - Maximum load capacity of each shelf: 15 kg

.P130001Q	Door stopper made of plastic and rubber	1 pc.
L0220015	Wooden shelf 50x46 cm for Hotel trolleys 851, 852 and 853	3 pcs
P202058U	Long base with wheels ø 125 mm	1 pc.
P816010U	Plastic bag holder 120 L with push-bar, bag-stretchers and reinforcements	1 pc.
Q1400130G	Plastified and reinforced back and side panels (3 parts) for Line 851 and 852, brown and grey	1 pc.
R1030122	Rilsan coated vertical frame, 111 cm high, for Hotel trolleys 600 and 800	2 pcs
R1230112	Rilsan coated reinforcing rod, 46 cm, for Morgan Hotel trolley	2 pcs

⚠ ACCESSORIES TO BE ORDERED SEPARATELY

8057A	Polyester bag capacity 150L, white with blue stripe	1 pc.
-------	---	-------

ON REQUEST, WITH SURCHARGE



REF.	PCK	VOLUME (m³)	GROSS WEIGHT (kg)	SIZE (cm) ↓ ↓ ↓
0000HP3342U	1	0,307	29,34	140x52x130

Suggested for 6 to 8 rooms - Maximum load capacity of each shelf: 15 kg

.P130001Q	Door stopper made of plastic and rubber	1 pc.
L0220015	Wooden shelf 50x46 cm for Hotel trolleys 851, 852 and 853	3 pcs
P202058U	Long base with wheels ø 125 mm	1 pc.
P314001U	Supporting plastic plate with wheel ø 125 mm	1 pc.
P816010U	Plastic bag holder 120 L with push-bar, bag-stretchers and reinforcements	1 pc.
Q1400130G	Plastified and reinforced back and side panels (3 parts) for Line 851 and 852, brown and grey	1 pc.
R1030122	Rilsan coated vertical frame, 111 cm high, for Hotel trolleys 600 and 800	2 pcs
R1230112	Rilsan coated reinforcing rod, 46 cm, for Morgan Hotel trolley	2 pcs

⚠ ACCESSORIES TO BE ORDERED SEPARATELY

8057A	Polyester bag capacity 150L, white with blue stripe	1 pc.
-------	---	-------

ON REQUEST, WITH SURCHARGE





MORGAN HOTEL ELEGANCE

ALPHA HOTEL

EMOTION

KEEPHOTEL

TROLLEYS FOR LAUNDRY COLLECTION

SILVER

Trolleys for laundry collection

MORGAN HOTEL 853 - trolley with wooden shelves

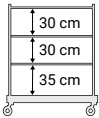

REF.	PCK	VOLUME (m³)	GROSS WEIGHT (kg)	SIZE (cm) ↓ ↓ ↓
0000HP3343U	1	0,307	28,14	104x52x130

Suggested for 6 to 8 rooms - Maximum load capacity of each shelf: 15 kg

.P130001Q	Door stopper made of plastic and rubber	1 pc.
L0220015	Wooden shelf 50x46 cm for Hotel trolleys 851, 852 and 853	3 pcs
P202058U	Long base with wheels ø 125 mm	1 pc.
P816010U	Plastic bag holder 120 L with push-bar, bag-stretchers and reinforcements	1 pc.
Q0400070G	Plastified and reinforced side panel with pockets, brown and grey	1 pc.
Q1400210G	Plastified and reinforced back and one side (2 parts) for Line 853, brown and grey	1 pc.
R1030122	Rilsan coated vertical frame, 111 cm high, for Hotel trolleys 600 and 800	2 pcs
R1230112	Rilsan coated reinforcing rod, 46 cm, for Morgan Hotel trolley	2 pcs

⚠ ACCESSORIES TO BE ORDERED SEPARATELY

8057A	Polyester bag capacity 150L, white with blue stripe	1 pc.
-------	---	-------

ON REQUEST, WITH SURCHARGE



LAUNDRY TROLLEY 3100 - trolley with bag



REF.	PCK	VOLUME (m³)	GROSS WEIGHT (kg)	SIZE (cm) ↓ ↓ ↓
0000HP3100U	1	0,166	11,8	88x49x88

.P130001Q	Door stopper made of plastic and rubber	1 pc.
P202008U	Short base with wheels ø 125 mm	1 pc.
Q0400102G	Brown plastified bag 200 L for laundry collection trolley with zip	1 pc.
R1030113	Rilsan coated vertical frame for laundry collection trolleys art. 0000HP3100U and 0000HP3110U	2 pcs

ON REQUEST, WITH SURCHARGE





MORGAN HOTEL ELEGANCE

ALPHA HOTEL

EMOTION

KEEPHOTEL

TROLLEYS FOR LAUNDRY
COLLECTION

SILVER

LAUNDRY TROLLEY 3110 - trolley with bag



REF.	PCK	VOLUME (m³)	GROSS WEIGHT (kg)	SIZE (cm) ↓ ↓ ↓
0000HP3110U	1	0,166	11,94	88x49x88

Available also in grey version with rubber wheels ø 125 mm and bumpers ø 200 mm art. 0000HP3110Q5

.P130001Q	Door stopper made of plastic and rubber	1 pc.
P202008U	Short base with wheels ø 125 mm	1 pc.
Q0400103G	Brown plastified bag 200 L for laundry collection trolley with zip and closure	1 pc.
R1030113	Rilsan coated vertical frame for laundry collection trolleys art. 0000HP3100U and 0000HP3110U	2 pcs

ON REQUEST, WITH SURCHARGE



LAUNDRY TROLLEY 3140 - trolley with bag



REF.	PCK	VOLUME (m³)	GROSS WEIGHT (kg)	SIZE (cm) ↓ ↓ ↓
0000HP3140U	1	0,191	18,48	126x52x108

.P130001Q	Door stopper made of plastic and rubber	1 pc.
P202008U	Short base with wheels ø 125 mm	1 pc.
P314001U	Supporting plastic plate with wheel ø 125 mm	1 pc.
P816010U	Plastic bag holder 120 L with push-bar, bag-stretchers and reinforcements	1 pc.
Q0400103G	Brown plastified bag 200 L for laundry collection trolley with zip and closure	1 pc.
R1030142	Rilsan coated vertical frame for laundry collection trolley art. 0000HP3140U	2 pcs
R1230113	Rilsan coated reinforcing rod, 66 cm, for Morgan Hotel trolley	2 pcs

⚠ ACCESSORIES TO BE ORDERED SEPARATELY

8057A	Polyester bag capacity 150L, white with blue stripe	1 pc.
-------	---	-------

ON REQUEST, WITH SURCHARGE

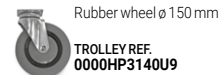



LAUNDRY TROLLEY 3101 - trolley with bag



REF.	PCK	VOLUME (m³)	GROSS WEIGHT (kg)	SIZE (cm) ↓ ↓ ↓
0000HP3101U	1	0,244	16	105x49x105

.P130001Q	Door stopper made of plastic and rubber	1 pc.
P202058U	Long base with wheels ø 125 mm	1 pc.
Q0400101G	Brown plastified bag 300 L for laundry collection trolley with zip	1 pc.
R1030144	Rilsan coated vertical frame for laundry collection trolley art. 0000HP3101U	2 pcs

ON REQUEST, WITH SURCHARGE

Rubber wheel ø 150 mm

TROLLEY REF.
0000HP3101U9

LAUNDRY TROLLEY 3100 - trolley with bag



REF.	PCK	VOLUME (m³)	GROSS WEIGHT (kg)	SIZE (cm) ↓ ↓ ↓
0000HP3103U	1	0,236	19,5	88x49x152,5

.P130001Q	Door stopper made of plastic and rubber	1 pc.
P202008U	Short base with wheels ø 125 mm	1 pc.
Q0400122P	Brown plastified bag 600 L for laundry collection trolley with front zip	1 pc.
R1030146	Rilsan coated vertical frame for laundry collection trolley art. 0000HP3103U	2 pcs
R1230113	Rilsan coated reinforcing rod, 66 cm, for Morgan Hotel trolley	6 pcs

ON REQUEST, WITH SURCHARGE

Rubber wheel ø 150 mm

TROLLEY REF.
0000HP3103U9



MORGAN HOTEL ELEGANCE

ALPHA HOTEL

EMOTION

KEEPHOTEL

TROLLEYS FOR LAUNDRY
COLLECTION

SILVER

Components for Morgan Hotel Elegance trolleys

Short plastic base



REF.	NOTES	SIZE (cm) ↓ ↓ ↓
P202008U	with wheels ø 125 mm	92x49
P202012U	with rubber wheels ø 150 mm	92x49

Long plastic base



REF.	NOTES	SIZE (cm) ↓ ↓ ↓
P202058U	with wheels ø 125 mm	105x49
P202063U	with rubber wheels ø 150 mm	105x49

Large plastic base for Light series



REF.	NOTES
P202051U	with ø 125 mm wheels and ø 130 mm bumpers
P202075U	with ø 150 mm rubber wheels and ø 130 mm bumpers

Supporting plastic plate with wheel



REF.	NOTES
P314001U	with wheel ø 125 mm
P314005U	with rubber wheel ø 125 mm

Supporting plastic plate with wheel and bumpers ø 200 mm



REF.	NOTES
P414001U	with wheel ø 125 mm
P414005U	with rubber wheel ø 125 mm

Supporting plate with wheel for Light serie



REF.	NOTES
P514000U	with wheel ø 125 mm
P514005U	with rubber wheel ø 125 mm



Supporting plastic plate for bucket 10 and 20 L fitting Morgan base



REF.	NOTES	SIZE (cm) ↓ ↓ ↓
P064000A		22x48x15
P064000U		22x48x15

Base extension for Alpha trolleys and for the bag supporting plastic plate of the Morgan Hotel Elegance trolleys



REF.	NOTES	SIZE (cm) ↓ ↓ ↓
P165000U	without castors	22x48
P065060U	with 2 wheels ø 125 mm	22x48



Rilsan coated vertical frame, 111 cm high, for Hotel trolleys 600 and 800



REF.	NOTES
R1030122	

Rilsan vertical frame with 2 bag holder retaining clips for Light series



REF.	NOTES
R2030161	

Rilsan coated vertical frame for laundry collection trolley



REF.	NOTES
R1030113	for art. 0000HP3100U and 0000HP3110U
R1030142	for art. 0000HP3140U
R1030144	for art. 0000HP3101U
R1030146	for art. 0000HP3103U

Rilsan coated reinforcing rod



REF.	NOTES	SIZE (cm) ↓ ↓ ↓
R1230110		81
R1230111		68
R1230112		46
R1230113		66

Housekeeping trolleys



- MORGAN HOTEL ELEGANCE
- ALPHA HOTEL
- EMOTION
- KEEPHOTEL
- TROLLEYS FOR LAUNDRY COLLECTION
- SILVER

Wooden shelf



REF.	NOTES	SIZE (cm) ↓ ↓ ↓
L0220013	for line 800	85,5x46
L0220014	for line 600	72,5x46
L0220015	for trolleys 851, 852 and 853	50x46

Fixing screw set for shelves



REF.	NOTES
0000SM00602	for 3 shelves (12 screws)
0000SM00603	for 2 shelves (8 screws)
0000SM00607	for 1 shelf (4 screws)

Wooden shelf with slots for one plastic sliding drawer



REF.	NOTES	SIZE (cm) ↓ ↓ ↓
L4220013	for line 800	85,5x46
L4220014	for line 600	72,5x46
L4220015	for trolleys 851, 852 and 853	50x46

Wooden shelf with slots for two plastic drawers



REF.	NOTES	SIZE (cm) ↓ ↓ ↓
L5220013	for line 800	85,5x46

Plastic sliding drawer without locking key



REF.	NOTES	CAPACITY (L)	SIZE (cm) ↓ ↓ ↓
P1229909U	internal dimensions 41x34x9,5 cm	10	46,5x37,5x11
P1229906U	internal dimensions 40,5x34x16 cm	22	46,5x37,5x17
P1229907U	internal dimensions 40x34x33,5 cm	40	46,5x37,5x35



Plastic sliding drawer with locking key



REF.	NOTES	CAPACITY (L)	SIZE (cm) ↓ ↓ ↓
P2229909U	internal dimensions 41x34x9,5 cm	10	46,5x37,5x11
P2229906A	internal dimensions 40,5x34x16 cm	22	46,5x37,5x17
P2229906B	internal dimensions 40,5x34x16 cm	22	46,5x37,5x17
P2229906U	internal dimensions 40,5x34x16 cm	22	46,5x37,5x17
P2229907U	internal dimensions 40x34x33,5 cm	40	46,5x37,5x35





MORGAN HOTEL ELEGANCE

ALPHA HOTEL

EMOTION

KEEPHOTEL

TROLLEYS FOR LAUNDRY
COLLECTION

SILVER

Galvanized steel rod 102 cm to fix the back panel

REF.	NOTES
I1900050	

Plastified and reinforced back and side panels (3 parts), brown and grey

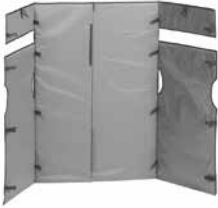

REF.	NOTES	SIZE (cm) ↓ ↓ ↓
Q1400010G	for line 800	178x103,5
Q1400030G	for line 600	165x103,5

Plastified and reinforced back and side panels (3 parts) for Line 851 and 852, brown and grey

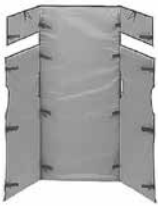

REF.	NOTES	SIZE (cm) ↓ ↓ ↓
Q1400130G		144x103,5

Full 3-sided grey reinforced plastic-coated cloth back, for Light series



REF.	NOTES
Q1400011E	

Plastified and reinforced panel, brown and grey



REF.	NOTES	SIZE (cm) ↓ ↓ ↓
Q1400090G	for line 800	87x103,5
Q1400110G	for line 600	73x103,5

Plastified and reinforced back and one side (2 parts) for Line 853, brown and grey



REF.	NOTES	SIZE (cm) ↓ ↓ ↓
Q1400210G		97x103,5

Housekeeping trolleys



- MORGAN HOTEL ELEGANCE
- ALPHA HOTEL
- EMOTION
- KEEPHOTEL
- TROLLEYS FOR LAUNDRY COLLECTION
- SILVER

Plastified and reinforced smooth side panel (2 pcs), brown and grey



REF.	NOTES	SIZE (cm) ↓ ↓ ↓
Q1400050G		47x103,5

Plastified and reinforced side panel with pockets, brown and grey



REF.	NOTES	SIZE (cm) ↓ ↓ ↓
Q0400070G		47x103,5

Multipurpose pocket for hotel disinfection



REF.	NOTES	SIZE (cm) ↓ ↓ ↓
Q0400075G		47x103,5



Brown plastified bag for laundry collection with zip



REF.	NOTES	CAPACITY (L)
Q0400101G	300 L	300
Q0400102G	200 L	200

Brown plastified bag 200 L for laundry collection trolley with zip and closure



REF.	NOTES
Q0400103G	

Brown plastified bag 600 L for laundry collection trolley with front zip



REF.	NOTES
Q0400122P	



MORGAN HOTEL ELEGANCE

ALPHA HOTEL

EMOTION

KEEPHOTEL

TROLLEYS FOR LAUNDRY
COLLECTION

SILVER

90l self-standing bag with strap tape system



REF.	NOTES
0000AT0185E	

For Morgan Hotel Light trolley bag holder

Plastic bag holder 120 L with push-bar, bag-stretchers and reinforcements



REF.	NOTES
P816010U	

Plastic bag holder 2x60 L with push-bar, bag-stretchers and reinforcements



REF.	NOTES
P516010U	

Rilsan 90l bag holder for Morgan Hotel Light



REF.	NOTES
R2060081	

Accessories for Morgan Hotel Elegance trolleys

Plastic divider for drawer 10 L



REF.	NOTES
0000SM00227D	9 compartments
0000SM00228D	12 compartments

Set of 1 big divider 39 cm + 1 medium divider 32 cm for plastic sliding drawer 22 L

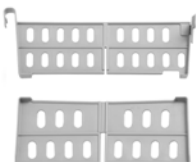

REF.	NOTES
0000SM00213U	

Housekeeping trolleys



- MORGAN HOTEL ELEGANCE
- ALPHA HOTEL
- EMOTION
- KEEPHOTEL
- TROLLEYS FOR LAUNDRY COLLECTION
- SILVER

Set of 1 big divider 39 cm + 3 small dividers 16 cm for plastic sliding drawer 22 L

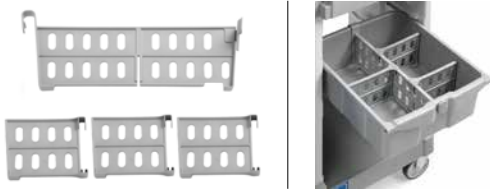

REF.	NOTES
0000SM00214U	

Brown plastified front covering



REF.	NOTES
Q0400220G	for line 600
Q0400230G	for line 800 (except versions 851-852-853)

Brown plastified front covering with elastic

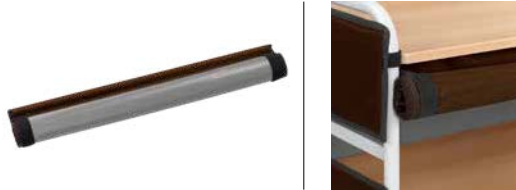

REF.	NOTES
Q0400221G	for line 600
Q0400231G	for line 800 (except versions 851-852-853)

Plastic cover for bag holder 120 L with storage room, check-list holder and lock

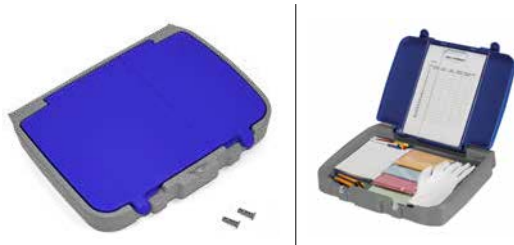

REF.	NOTES
P291920UA	
P291920UB	
P291920U	

Please, require also no. 2 shock absorbing pistons art. P190908U for a perfect soft closing

Shock absorbing piston for a soft closing of the cover



REF.	NOTES
P190908U	



Plastic tray for guest amenities



REF.	NOTES	SIZE (cm)
P219004U		↓ ↓ ↓ 28x43x9
P219005U		55x43x9



Plastified tray for guest amenities



REF.	NOTES	SIZE (cm)
Q0400104		66x46
Q0400117		43x46

Rilsan coated coupling device to connect the laundry trolley to the Morgan Hotel trolleys



REF.	NOTES
R1180050	

Bathrobe holder kit with pockets complete with double fixing clip with screws



REF.	NOTES
Q1400118U	

Recommended with bag supporting plastic plate

Rilsan coated hand towels and toilet paper dispenser



REF.	NOTES
R1900050	

Rilsan coated external vertical frame h 109 cm complete with 2 fixing clips (special shaped in the lower part)



REF.	NOTES
R2030106	

Side plastic basket for Morgan Hotel fitting vertical frame ref. R2030106



REF.	NOTES
P119002U	internal sizes 18,5x49,5x11 cm

Housekeeping trolleys



- MORGAN HOTEL ELEGANCE
- ALPHA HOTEL
- EMOTION
- KEEPHOTEL
- TROLLEYS FOR LAUNDRY COLLECTION
- SILVER

Rilsan coated support 70 L with bag stretcher fitting special shaped vertical frame



REF.	NOTES
R2060080	

Grey waste collection bin 16 L with handle



REF.	NOTES	CAPACITY (L)	SIZE (cm) ↓ ↓ ↓
8168U		16	16x26x50

Rilsan coated holder for plastic bin 16 L, fitting special shaped vertical frame



REF.	NOTES
R2200050	

Rilsan coated vertical frame 52 cm high complete with 4 fixing clips



REF.	NOTES
R3030135	

Rilsan coated basket holder for basket art. P1191100U fitting vertical frame art. R2030135



REF.	NOTES
R2200051	

Side plastic basket



REF.	NOTES
P1191100U	internal sizes 22x49x11,5 cm

Rilsan coated bucket holder for buckets 10 and 20 L fitting Morgan vertical frame and Alpha trolley



REF.	NOTES
R2200040	



Alpha Hotel: comfortable and functional service trolley

Alpha Hotel trolleys have a plain and simple design to fit any environment. Partially made of PSV - Second Life Plastic - certified plastic components, they are available in open versions or with closing doors for maximum safety.



The Alpha Hotel range features utmost care of all details and a specific design conceived to ensure practicality, efficiency and functionality.

Better functionality

The models with two storage units have a left opening door, for **convenience** and **practicality**.



Innovative closing mechanism to work safe

Organize your services and work better

The versions without central vertical frame ensure **high trolley capacity**, so that everything that may be needed for the job can be right at hand.



Alpha Hotel Drive

Alpha Hotel Drive Trolleys can be used to move loads of up to 150 kg on several types of floors with slopes up to 8%, **without any strain** for the operator. Equipped with a **removable key** to switch on the control console, the motor-driven versions are **easy to manoeuvre**, do not need to be pushed and provide **maximum safety**. Being **extremely quiet**, they do not cause disturbance, and are therefore ideal for cleaning and tidying activities inside welcoming establishments

Unhook the trolley and go

Thanks to **Link-Up**, the **new hook system** designed by Filmop, it will be possible to separate the bag holder compartment from the rest of the trolley with a simple click.

The **new independent waste collection unit** allows to move around more freely and comfortably during all waste or laundry disposal operations and to gain access easier to small and reduced areas, such as elevators, small hallways and laundries.

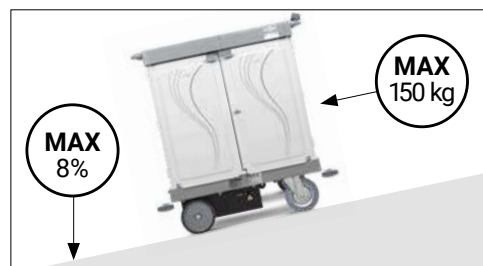



Baskets set for Alpha trolleys

The exclusive set of central trays for Alpha Hotel trolleys is an essential accessory to offer the **maximum convenience** and **safety**.

The practical set **doubles the storage capacity**, allowing you to further optimize your service trolley: it offers two open storage areas and two areas with **cover with locking key**, which can be organized according to your specific needs.



The set of central trays is characterized by a **well-finished design** in line with the **simple and elegant style** of the whole Alpha Hotel range of trolleys.





MORGAN HOTEL ELEGANCE

ALPHA HOTEL

EMOTION

KEEPHOTEL

TROLLEYS FOR LAUNDRY
COLLECTION

SILVER

Open version trolleys

ALPHA HOTEL 2300-05 - plastic trolley



REF.	PCK	VOLUME (m³)	GROSS WEIGHT (kg)	SIZE (cm) ↓ ↓ ↓
0300HA2300U05	1	0,261	16,05	99x58x107

Suggested for 4 to 5 rooms - Maximum pull-out shelf capacity 15 kg

.P130001Q	Door stopper made of plastic and rubber	1 pc.
0000SM00165	Set of T-shaped light grey closing plugs for vertical frames (6 pcs)	2 pcs
P059031U	Short base with rubber wheels ø 125 mm	1 pc.
P1229900U	Set of plastic shelves (2 pcs)	1 pc.
P165000U	Base extension for Alpha trolleys and for the bag supporting plastic plate of the Morgan Hotel Elegance trolleys	1 pc.
P2039903E	Vertical frame, 1 side with slides + 1 side for T-plugs, complete with screws and plugs	2 pcs
P2199906U	Central plastic basket (female-female version) with plugs	1 pc.
P2909921U	Closing profile with push-grip for central basket and central bag holder complete with screws and plugs	1 pc.
P3059953E	Fixed side wall with fixing pins	1 pc.
P8161113U	Folding 120l waste bag holder, with bag retaining hooks, dustpan hook, handle clip, screws and plugs	1 pc.

⚠️ ACCESSORIES TO BE ORDERED SEPARATELY

0000AT0120E	Plastic coated bag 120L with grip, grey	1 pc.
-------------	---	-------

ALPHA HOTEL 5300-06 - plastic trolley



REF.	PCK	VOLUME (m³)	GROSS WEIGHT (kg)	SIZE (cm) ↓ ↓ ↓
0300HA5300U06	1	0,372	25,17	142x58x107

Suggested for 8 to 10 rooms - Maximum pull-out shelf capacity 15 kg

.P130001Q	Door stopper made of plastic and rubber	1 pc.
0000SM00165	Set of T-shaped light grey closing plugs for vertical frames (6 pcs)	2 pcs
P066031U	Long base with rubber wheels ø 125 mm	1 pc.
P1229900U	Set of plastic shelves (2 pcs)	2 pcs
P175000U	Supporting plastic plate for Alpha trolleys	1 pc.
P2039903E	Vertical frame, 1 side with slides + 1 side for T-plugs, complete with screws and plugs	2 pcs
P2039904E	Vertical frame, 2 sides with slides, complete with screws and plugs	1 pc.
P2199906U	Central plastic basket (female-female version) with plugs	1 pc.
P2199907U	Central plastic basket (male-female version) with screws and plugs	1 pc.
P2909921U	Closing profile with push-grip for central basket and central bag holder complete with screws and plugs	1 pc.
P3059953E	Fixed side wall with fixing pins	2 pcs
P8161113U	Folding 120l waste bag holder, with bag retaining hooks, dustpan hook, handle clip, screws and plugs	1 pc.

⚠️ ACCESSORIES TO BE ORDERED SEPARATELY

0000AT0120E	Plastic coated bag 120L with grip, grey	1 pc.
-------------	---	-------





MORGAN HOTEL ELEGANCE

ALPHA HOTEL

EMOTION

KEEPHOTEL

TROLLEYS FOR LAUNDRY
COLLECTION

SILVER

ALPHA HOTEL 5301-06 - plastic trolley



REF.	PCK	VOLUME (m³)	GROSS WEIGHT (kg)	SIZE (cm) ↓ ↓ ↓
0500HA5301U06	1	0,372	29,27	177x58x107

Suggested for 8 to 10 rooms - Maximum pull-out shelf capacity 15 kg

.P130001Q	Door stopper made of plastic and rubber	1 pc.
0000SM00165	Set of T-shaped light grey closing plugs for vertical frames (6 pcs)	2 pcs
P066031U	Long base with rubber wheels ø 125 mm	1 pc.
P1229900U	Set of plastic shelves (2 pcs)	2 pcs
P175000U	Supporting plastic plate for Alpha trolleys	2 pcs
P2039903E	Vertical frame, 1 side with slides + 1 side for T-plugs, complete with screws and plugs	2 pcs
P2039904E	Vertical frame, 2 sides with slides, complete with screws and plugs	1 pc.
P2199906U	Central plastic basket (female-female version) with plugs	1 pc.
P2199907U	Central plastic basket (male-female version) with screws and plugs	1 pc.
P3059953E	Fixed side wall with fixing pins	2 pcs
P8161113U	Folding 120l waste bag holder, with bag retaining hooks, dustpan hook, handle clip, screws and plugs	2 pcs

⚠ ACCESSORIES TO BE ORDERED SEPARATELY

0000AT0120E	Plastic coated bag 120L with grip, grey	2 pcs
-------------	---	-------

ALPHA HOTEL 5304-06 - plastic trolley



REF.	PCK	VOLUME (m³)	GROSS WEIGHT (kg)	SIZE (cm) ↓ ↓ ↓
0300HA5304U06	1	0,372	26,7	153x58x107

Suggested for 8 to 10 rooms - Maximum pull-out shelf capacity 15 kg

.P130001Q	Door stopper made of plastic and rubber	1 pc.
0000SM00165	Set of T-shaped light grey closing plugs for vertical frames (6 pcs)	2 pcs
P066031U	Long base with rubber wheels ø 125 mm	1 pc.
P1191100U	Side plastic basket	2 pcs
P1229900U	Set of plastic shelves (2 pcs)	2 pcs
P175000U	Supporting plastic plate for Alpha trolleys	1 pc.
P2039903E	Vertical frame, 1 side with slides + 1 side for T-plugs, complete with screws and plugs	2 pcs
P2039904E	Vertical frame, 2 sides with slides, complete with screws and plugs	1 pc.
P2199906U	Central plastic basket (female-female version) with plugs	1 pc.
P2199907U	Central plastic basket (male-female version) with screws and plugs	1 pc.
P2909920U	Closing profile for central basket and central bag holder, with screws and plugs	1 pc.
P3059953E	Fixed side wall with fixing pins	2 pcs
P8161113U	Folding 120l waste bag holder, with bag retaining hooks, dustpan hook, handle clip, screws and plugs	1 pc.

⚠ ACCESSORIES TO BE ORDERED SEPARATELY

0000AT0120E	Plastic coated bag 120L with grip, grey	1 pc.
-------------	---	-------





MORGAN HOTEL ELEGANCE

ALPHA HOTEL

EMOTION

KEEPHOTEL

TROLLEYS FOR LAUNDRY
COLLECTION

SILVER

ALPHA HOTEL 5302-98 - plastic trolley



REF.	PCK	VOLUME (m³)	GROSS WEIGHT (kg)	SIZE (cm) ↓ ↓ ↓
0000HA5302U98	1	0,261	18,75	97x58x107

Suggested for 8 to 10 rooms - Maximum pull-out shelf capacity 30 kg

.P130001Q	Door stopper made of plastic and rubber	1 pc.
0000SM00033E	Blocking device for side walls for Alpha trolleys	1 pc.
0000SM00165	Set of T-shaped light grey closing plugs for vertical frames (6 pcs)	2 pcs
P066031U	Long base with rubber wheels ø 125 mm	1 pc.
P2039908E	Vertical frame 1 side with slides + 1 side T-plugs with reinforcements, screws and plugs	2 pcs
P2229911U	Plastic Shelf 46,5x79 cm	1 pc.
P2909920U	Closing profile for central basket and central bag holder, with screws and plugs	1 pc.
P2909921U	Closing profile with push-grip for central basket and central bag holder complete with screws and plugs	1 pc.
P3059953E	Fixed side wall with fixing pins	2 pcs
P3199908U	Set with 2 central basket, screws and plugs	1 pc.

ALPHA HOTEL 5300-98 - plastic trolley



REF.	PCK	VOLUME (m³)	GROSS WEIGHT (kg)	SIZE (cm) ↓ ↓ ↓
0300HA5300U98	1	0,27	22,07	142x58x107

Suggested for 8 to 10 rooms - Maximum pull-out shelf capacity 30 kg

.P130001Q	Door stopper made of plastic and rubber	1 pc.
0000SM00033E	Blocking device for side walls for Alpha trolleys	1 pc.
0000SM00165	Set of T-shaped light grey closing plugs for vertical frames (6 pcs)	2 pcs
P066031U	Long base with rubber wheels ø 125 mm	1 pc.
P175000U	Supporting plastic plate for Alpha trolleys	1 pc.
P2039908E	Vertical frame 1 side with slides + 1 side T-plugs with reinforcements, screws and plugs	2 pcs
P2229911U	Plastic Shelf 46,5x79 cm	1 pc.
P2909921U	Closing profile with push-grip for central basket and central bag holder complete with screws and plugs	1 pc.
P3059953E	Fixed side wall with fixing pins	2 pcs
P3199908U	Set with 2 central basket, screws and plugs	1 pc.
P8161113U	Folding 120L waste bag holder, with bag retaining hooks, dustpan hook, handle clip, screws and plugs	1 pc.

⚠ ACCESSORIES TO BE ORDERED SEPARATELY

0000AT0120E	Plastic coated bag 120L with grip, grey	1 pc.
-------------	---	-------





MORGAN HOTEL ELEGANCE

ALPHA HOTEL

EMOTION

KEEPHOTEL

TROLLEYS FOR LAUNDRY
COLLECTION

SILVER

ALPHA HOTEL HR5300-98 - plastic trolley with Link-Up system



REF.	PCK	VOLUME (m³)	GROSS WEIGHT (kg)	SIZE (cm) ↓ ↓ ↓
0300HR5300U98	1	0,438	33,65	153x58x107

Suggested for 8 to 10 rooms - Maximum pull-out shelf capacity 30 kg

.P130001Q	Door stopper made of plastic and rubber	1 pc.
0000SM00033E	Blocking device for side walls for Alpha trolleys	1 pc.
0000SM00163	Set of T-shaped dark grey closing plugs for vertical frames (6 pcs)	1 pc.
0000SM00165	Set of T-shaped light grey closing plugs for vertical frames (6 pcs)	2 pcs
0000SM00617	Quick connection kit Link-Up (4 pcs)	1 pc.
P025031U	Compact base with wheels ø 125 mm	1 pc.
P066031U	Long base with rubber wheels ø 125 mm	1 pc.
P1909967U	Closing profile for bag holder 120 L	1 pc.
P2031103U	Vertical frame with reinforcement, 1 smooth side + 1 side for T-plugs, complete with screws	1 pc.
P2039908E	Vertical frame 1 side with slides + 1 side T-plugs with reinforcements, screws and plugs	2 pcs
P2229911U	Plastic Shelf 46,5x79 cm	1 pc.
P2909920U	Closing profile for central basket and central bag holder, with screws and plugs	1 pc.
P2909921U	Closing profile with push-grip for central basket and central bag holder complete with screws and plugs	1 pc.
P3059953E	Fixed side wall with fixing pins	2 pcs
P3199908U	Set with 2 central basket, screws and plugs	1 pc.
P8161111U	120L waste bag holder, male fitting, with dustpan hook and handle clip	1 pc.

⚠ ACCESSORIES TO BE ORDERED SEPARATELY

0000AT0120E	Plastic coated bag 120L with grip, grey	1 pc.
-------------	---	-------

ALPHA HOTEL 5503006 - plastic trolley



REF.	PCK	VOLUME (m³)	GROSS WEIGHT (kg)	SIZE (cm) ↓ ↓ ↓
HA5503006U000	1	0,31	27,39	142x58x107

Suggested for 8 to 10 rooms - Maximum pull-out shelf capacity 30 kg

.P130001Q	Door stopper made of plastic and rubber	1 pc.
0000SM00033E	Blocking device for side walls for Alpha trolleys	1 pc.
0000SM00165	Set of T-shaped light grey closing plugs for vertical frames (6 pcs)	2 pcs
P066031U	Long base with rubber wheels ø 125 mm	1 pc.
P175000U	Supporting plastic plate for Alpha trolleys	1 pc.
P2039908E	Vertical frame 1 side with slides + 1 side T-plugs with reinforcements, screws and plugs	2 pcs
P2229911U	Plastic Shelf 46,5x79 cm	1 pc.
P2909921U	Closing profile with push-grip for central basket and central bag holder complete with screws and plugs	1 pc.
P3059953E	Fixed side wall with fixing pins	2 pcs
P3199928U	Set with 2 central baskets with dividers, 2 grey covers, screws and plugs	1 pc.
P8161113U	Folding 120L waste bag holder, with bag retaining hooks, dustpan hook, handle clip, screws and plugs	1 pc.

⚠ ACCESSORIES TO BE ORDERED SEPARATELY

0000AT0120E	Plastic coated bag 120L with grip, grey	1 pc.
-------------	---	-------





MORGAN HOTEL ELEGANCE

ALPHA HOTEL

EMOTION

KEEPHOTEL

TROLLEYS FOR LAUNDRY
COLLECTION

SILVER

Closed version trolleys

ALPHA HOTEL 5301-98 - plastic trolley



REF.	PCK	VOLUME (m³)	GROSS WEIGHT (kg)	SIZE (cm) ↓ ↓ ↓
0500HA5301U98	1	0,372	27,87	177x58x107

Suggested for 8 to 10 rooms - Maximum pull-out shelf capacity 30 kg

.P130001Q	Door stopper made of plastic and rubber	1 pc.
0000SM00033E	Blocking device for side walls for Alpha trolleys	1 pc.
0000SM00165	Set of T-shaped light grey closing plugs for vertical frames (6 pcs)	2 pcs
P066031U	Long base with rubber wheels ø 125 mm	1 pc.
P175000U	Supporting plastic plate for Alpha trolleys	2 pcs
P2039908E	Vertical frame 1 side with slides + 1 side T-plugs with reinforcements, screws and plugs	2 pcs
P2229911U	Plastic Shelf 46,5x79 cm	1 pc.
P3059953E	Fixed side wall with fixing pins	2 pcs
P3199908U	Set with 2 central basket, screws and plugs	1 pc.
P8161113U	Folding 120l waste bag holder, with bag retaining hooks, dustpan hook, handle clip, screws and plugs	2 pcs

ACCESSORIES TO BE ORDERED SEPARATELY

0000AT0120E	Plastic coated bag 120L with grip, grey	2 pcs
-------------	---	-------

ALPHA HOTEL 0603002 - plastic trolley

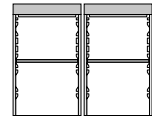

REF.	PCK	VOLUME (m³)	GROSS WEIGHT (kg)	SIZE (cm) ↓ ↓ ↓
HA0603002U000	1	0,31	22,63	97x58x107

Suggested for 8 to 10 rooms - Maximum pull-out shelf capacity 15 kg

.P130001Q	Door stopper made of plastic and rubber	1 pc.
0000SM00165	Set of T-shaped light grey closing plugs for vertical frames (6 pcs)	2 pcs
P066031U	Long base with rubber wheels ø 125 mm	1 pc.
P1229900U	Set of plastic shelves (2 pcs)	2 pcs
P2039903E	Vertical frame, 1 side with slides + 1 side for T-plugs, complete with screws and plugs	2 pcs
P2039904E	Vertical frame, 2 sides with slides, complete with screws and plugs	1 pc.
P2199906U	Central plastic basket (female-female version) with plugs	1 pc.
P2199907U	Central plastic basket (male-female version) with screws and plugs	1 pc.
P2909920U	Closing profile for central basket and central bag holder, with screws and plugs	1 pc.
P2909921U	Closing profile with push-grip for central basket and central bag holder complete with screws and plugs	1 pc.
P3059953E	Fixed side wall with fixing pins	2 pcs
P3059954E	Right door with fixing pins	1 pc.
P3059974E	Left door with fixing pins	1 pc.





MORGAN HOTEL ELEGANCE

ALPHA HOTEL

EMOTION

KEEPHOTEL

TROLLEYS FOR LAUNDRY
COLLECTION

SILVER

ALPHA HOTEL 0603005 - plastic trolley

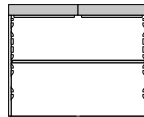

ALPHA HOTEL 3300-05 - plastic trolley

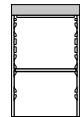

REF.	PCK	VOLUME (m³)	GROSS WEIGHT (kg)	SIZE (cm)
HA0603005U000	1	0,31	27,58	97x58x107

Suggested for 8 to 10 rooms - Maximum pull-out shelf capacity 30 kg

.P130001Q	Door stopper made of plastic and rubber	1 pc.
0000SM00033E	Blocking device for side walls for Alpha trolleys	1 pc.
0000SM00165	Set of T-shaped light grey closing plugs for vertical frames (6 pcs)	2 pcs
P166031U	Big base with five ø 125 mm rubber wheels	1 pc.
P2039908E	Vertical frame 1 side with slides + 1 side T-plugs with reinforcements, screws and plugs	2 pcs
P2229911U	Plastic Shelf 46,5x79 cm	1 pc.
P2909920U	Closing profile for central basket and central bag holder, with screws and plugs	1 pc.
P2909921U	Closing profile with push-grip for central basket and central bag holder complete with screws and plugs	1 pc.
P3059953E	Fixed side wall with fixing pins	2 pcs
P3059977E	Right and left wing door set for Alpha trolleys	1 pc.
P3199908U	Set with 2 central basket, screws and plugs	1 pc.

REF.	PCK	VOLUME (m³)	GROSS WEIGHT (kg)	SIZE (cm)
0300HA3300U05	1	0,261	21,15	99x58x107

Suggested for 4 to 5 rooms - Maximum pull-out shelf capacity 15 kg

.P130001Q	Door stopper made of plastic and rubber	1 pc.
0000SM00165	Set of T-shaped light grey closing plugs for vertical frames (6 pcs)	2 pcs
P059031U	Short base with rubber wheels ø 125 mm	1 pc.
P1229900U	Set of plastic shelves (2 pcs)	1 pc.
P165000U	Base extension for Alpha trolleys and for the bag supporting plastic plate of the Morgan Hotel Elegance trolleys	1 pc.
P2039903E	Vertical frame, 1 side with slides + 1 side for T-plugs, complete with screws and plugs	2 pcs
P2199906U	Central plastic basket (female-female version) with plugs	1 pc.
P2909921U	Closing profile with push-grip for central basket and central bag holder complete with screws and plugs	1 pc.
P3059953E	Fixed side wall with fixing pins	1 pc.
P3059954E	Right door with fixing pins	1 pc.
P816113U	Folding 120L waste bag holder, with bag retaining hooks, dustpan hook, handle clip, screws and plugs	1 pc.

⚠ ACCESSORIES TO BE ORDERED SEPARATELY

0000AT0120E	Plastic coated bag 120L with grip, grey	1 pc.
-------------	---	-------





MORGAN HOTEL ELEGANCE

ALPHA HOTEL

EMOTION

KEEPHOTEL

TROLLEYS FOR LAUNDRY
COLLECTION

SILVER

ALPHA HOTEL 0603003 - plastic trolley

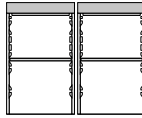

REF.	PCK	VOLUME (m³)	GROSS WEIGHT (kg)	SIZE (cm)
HA0603003U000	1	0,372	27,17	142x58x107

Suggested for 8 to 10 rooms - Maximum pull-out shelf capacity 15 kg

.P130001Q	Door stopper made of plastic and rubber	1 pc.
0000SM00165	Set of T-shaped light grey closing plugs for vertical frames (6 pcs)	2 pcs
P066031U	Long base with rubber wheels ø 125 mm	1 pc.
P1229900U	Set of plastic shelves (2 pcs)	2 pcs
P175000U	Supporting plastic plate for Alpha trolleys	1 pc.
P2039903E	Vertical frame, 1 side with slides + 1 side for T-plugs, complete with screws and plugs	2 pcs
P2039904E	Vertical frame, 2 sides with slides, complete with screws and plugs	1 pc.
P2199906U	Central plastic basket (female-female version) with plugs	1 pc.
P2199907U	Central plastic basket (male-female version) with screws and plugs	1 pc.
P2909921U	Closing profile with push-grip for central basket and central bag holder complete with screws and plugs	1 pc.
P3059953E	Fixed side wall with fixing pins	2 pcs
P3059954E	Right door with fixing pins	1 pc.
P3059974E	Left door with fixing pins	1 pc.
P8161113U	Folding 120L waste bag holder, with bag retaining hooks, dustpan hook, handle clip, screws and plugs	1 pc.

⚠ ACCESSORIES TO BE ORDERED SEPARATELY

0000AT0120E	Plastic coated bag 120L with grip, grey	1 pc.
-------------	---	-------

ALPHA HOTEL HR0603003 - plastic trolley with Link-Up system

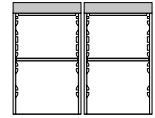

REF.	PCK	VOLUME (m³)	GROSS WEIGHT (kg)	SIZE (cm)
HR0603003U000	1	0,549	45	153x58x107

Suggested for 8 to 10 rooms - Maximum pull-out shelf capacity 15 kg

.P130001Q	Door stopper made of plastic and rubber	1 pc.
0000SM00163	Set of T-shaped dark grey closing plugs for vertical frames (6 pcs)	1 pc.
0000SM00165	Set of T-shaped light grey closing plugs for vertical frames (6 pcs)	2 pcs
0000SM00617	Quick connection kit Link-Up (4 pcs)	1 pc.
P025031U	Compact base with wheels ø 125 mm	1 pc.
P066031U	Long base with rubber wheels ø 125 mm	1 pc.
P1229900U	Set of plastic shelves (2 pcs)	2 pcs
P1909967U	Closing profile for bag holder 120 L	1 pc.
P2031103U	Vertical frame with reinforcement, 1 smooth side+ 1 side for T-plugs, complete with screws	1 pc.
P2039903E	Vertical frame, 1 side with slides + 1 side for T-plugs, complete with screws and plugs	2 pcs
P2039904E	Vertical frame, 2 sides with slides, complete with screws and plugs	1 pc.
P2199906U	Central plastic basket (female-female version) with plugs	1 pc.
P2199907U	Central plastic basket (male-female version) with screws and plugs	1 pc.
P2909920U	Closing profile for central basket and central bag holder, with screws and plugs	1 pc.
P2909921U	Closing profile with push-grip for central basket and central bag holder complete with screws and plugs	1 pc.
P3059953E	Fixed side wall with fixing pins	2 pcs
P3059954E	Right door with fixing pins	1 pc.
P3059974E	Left door with fixing pins	1 pc.
P8161111U	120L waste bag holder, male fitting, with dustpan hook and handle clip	1 pc.

⚠ ACCESSORIES TO BE ORDERED SEPARATELY

0000AT0120E	Plastic coated bag 120L with grip, grey	1 pc.
-------------	---	-------





MORGAN HOTEL ELEGANCE

ALPHA HOTEL

EMOTION

KEEPHOTEL

TROLLEYS FOR LAUNDRY
COLLECTION

SILVER

ALPHA HOTEL 5603003 - plastic trolley



REF.	PCK	VOLUME (m³)	GROSS WEIGHT (kg)	SIZE (cm)
HA5603003U000	1	0,372	29,77	142x58x107

Suggested for 8 to 10 rooms - Maximum pull-out shelf capacity 15 kg

.P130001Q	Door stopper made of plastic and rubber	1 pc.
0000SM00165	Set of T-shaped light grey closing plugs for vertical frames (6 pcs)	2 pcs
P066031U	Long base with rubber wheels ø 125 mm	1 pc.
P1229900U	Set of plastic shelves (2 pcs)	2 pcs
P175000U	Supporting plastic plate for Alpha trolleys	1 pc.
P2039903E	Vertical frame, 1 side with slides + 1 side for T-plugs, complete with screws and plugs	2 pcs
P2039904E	Vertical frame, 2 sides with slides, complete with screws and plugs	1 pc.
P2199926U	Central basket (female-female version) with divider, grey cover and plugs	1 pc.
P2199927U	Central basket (male-female version) with divider, grey cover, screws and plugs	1 pc.
P2909921U	Closing profile with push-grip for central basket and central bag holder complete with screws and plugs	1 pc.
P3059953E	Fixed side wall with fixing pins	2 pcs
P3059954E	Right door with fixing pins	1 pc.
P3059974E	Left door with fixing pins	1 pc.
P8161113U	Folding 120L waste bag holder, with bag retaining hooks, dustpan hook, handle clip, screws and plugs	1 pc.

⚠ ACCESSORIES TO BE ORDERED SEPARATELY

0000AT0120E	Plastic coated bag 120L with grip, grey	1 pc.
-------------	---	-------

ALPHA HOTEL HR0603006 - plastic trolley with Link-Up system

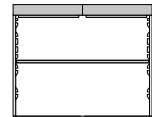

REF.	PCK	VOLUME (m³)	GROSS WEIGHT (kg)	SIZE (cm)
HR0603006U000	1	0,487	42,5	153x58x107

Suggested for 8 to 10 rooms - Maximum pull-out shelf capacity 30 kg

.P130001Q	Door stopper made of plastic and rubber	1 pc.
0000SM00033E	Blocking device for side walls for Alpha trolleys	1 pc.
0000SM00163	Set of T-shaped dark grey closing plugs for vertical frames (6 pcs)	1 pc.
0000SM00165	Set of T-shaped light grey closing plugs for vertical frames (6 pcs)	2 pcs
0000SM00617	Quick connection kit Link-Up (4 pcs)	1 pc.
P025031U	Compact base with wheels ø 125 mm	1 pc.
P166031U	Big base with five ø 125 mm rubber wheels	1 pc.
P1909967U	Closing profile for bag holder 120 L	1 pc.
P2031103U	Vertical frame with reinforcement, 1 smooth side+ 1 side for T-plugs, complete with screws	1 pc.
P2039908E	Vertical frame 1 side with slides + 1 side T-plugs with reinforcements, screws and plugs	2 pcs
P2229911U	Plastic Shelf 46,5x79 cm	1 pc.
P2909920U	Closing profile for central basket and central bag holder, with screws and plugs	1 pc.
P2909921U	Closing profile with push-grip for central basket and central bag holder complete with screws and plugs	1 pc.
P3059953E	Fixed side wall with fixing pins	2 pcs
P3059977E	Right and left wing door set for Alpha trolleys	1 pc.
P3199908U	Set with 2 central basket, screws and plugs	1 pc.
P8161111U	120L waste bag holder, male fitting, with dustpan hook and handle clip	1 pc.

⚠ ACCESSORIES TO BE ORDERED SEPARATELY

0000AT0120E	Plastic coated bag 120L with grip, grey	1 pc.
-------------	---	-------





MORGAN HOTEL ELEGANCE

ALPHA HOTEL

EMOTION

KEEPHOTEL

TROLLEYS FOR LAUNDRY
COLLECTION

SILVER

Alpha Hotel Drive

ALPHA HOTEL 0603004 - plastic trolley

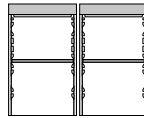

ALPHA HOTEL DRIVE 0648005 - plastic trolley

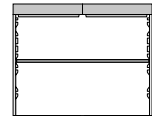

REF.	PCK	VOLUME (m³)	GROSS WEIGHT (kg)	SIZE (cm) ↓ ↓ ↓
HA0603004U000	1	0,372	31,67	177x58x107

Suggested for 8 to 10 rooms - Maximum pull-out shelf capacity 15 kg

.P130001Q	Door stopper made of plastic and rubber	1 pc.
0000SM00165	Set of T-shaped light grey closing plugs for vertical frames (6 pcs)	2 pcs
P066031U	Long base with rubber wheels ø 125 mm	1 pc.
P1229900U	Set of plastic shelves (2 pcs)	2 pcs
P175000U	Supporting plastic plate for Alpha trolleys	2 pcs
P2039903E	Vertical frame, 1 side with slides + 1 side for T-plugs, complete with screws and plugs	2 pcs
P2039904E	Vertical frame, 2 sides with slides, complete with screws and plugs	1 pc.
P2199906U	Central plastic basket (female-female version) with plugs	1 pc.
P2199907U	Central plastic basket (male-female version) with screws and plugs	1 pc.
P3059953E	Fixed side wall with fixing pins	2 pcs
P3059954E	Right door with fixing pins	1 pc.
P3059974E	Left door with fixing pins	1 pc.
P8161113U	Folding 120L waste bag holder, with bag retaining hooks, dustpan hook, handle clip, screws and plugs	2 pcs

⚠ ACCESSORIES TO BE ORDERED SEPARATELY

0000AT0120E	Plastic coated bag 120L with grip, grey	2 pcs
-------------	---	-------

REF.	PCK	VOLUME (m³)	GROSS WEIGHT (kg)	SIZE (cm) ↓ ↓ ↓
HA0648005U000	1	1,71	66	97x58x114

Suggested for 8 to 10 rooms - Maximum pull-out shelf capacity 30 kg

.P130001Q	Door stopper made of plastic and rubber	1 pc.
0000SM00033E	Blocking device for side walls for Alpha trolleys	1 pc.
0000SM00165	Set of T-shaped light grey closing plugs for vertical frames (6 pcs)	2 pcs
P2039908E	Vertical frame 1 side with slides + 1 side T-plugs with reinforcements, screws and plugs	2 pcs
P2229911U	Plastic Shelf 46,5x79 cm	1 pc.
P266481U	Long base with 2 rubber wheels ø 200x50 mm and 4 bumpers complete with motor kit	1 pc.
P2909920U	Closing profile for central basket and central bag holder, with screws and plugs	1 pc.
P2909921U	Closing profile with push-grip for central basket and central bag holder complete with screws and plugs	1 pc.
P3059953E	Fixed side wall with fixing pins	2 pcs
P3059977E	Right and left wing door set for Alpha trolleys	1 pc.
P3199908U	Set with 2 central basket, screws and plugs	1 pc.

⚠ ACCESSORIES TO BE ORDERED SEPARATELY

00BL1000	Lithium battery	1 pc.
----------	-----------------	-------





MORGAN HOTEL ELEGANCE

ALPHA HOTEL

EMOTION

KEEPHOTEL

TROLLEYS FOR LAUNDRY
COLLECTION

SILVER

ALPHA HOTEL DRIVE 0648003 - plastic trolley

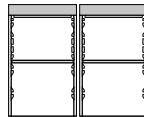

REF.	PCK	VOLUME (m³)	GROSS WEIGHT (kg)	SIZE (cm)
HA0648003U000	1	1,71	63,5	142x58x114

Suggested for 8 to 10 rooms - Maximum pull-out shelf capacity 15 kg

.P130001Q	Door stopper made of plastic and rubber	1 pc.
0000SM00165	Set of T-shaped light grey closing plugs for vertical frames (6 pcs)	2 pcs
P066481U	Long base with 2 rubber wheels ø 200x50 mm and 2 bumpers complete with motor kit	1 pc.
P1229900U	Set of plastic shelves (2 pcs)	2 pcs
P1901109U	Blocking plug for supporting plastic plate	2 pcs
P2039903E	Vertical frame, 1 side with slides + 1 side for T-plugs, complete with screws and plugs	2 pcs
P2039904E	Vertical frame, 2 sides with slides, complete with screws and plugs	1 pc.
P2199906U	Central plastic basket (female-female version) with plugs	1 pc.
P2199907U	Central plastic basket (male-female version) with screws and plugs	1 pc.
P2909921U	Closing profile with push-grip for central basket and central bag holder complete with screws and plugs	1 pc.
P3059953E	Fixed side wall with fixing pins	2 pcs
P3059954E	Right door with fixing pins	1 pc.
P3059974E	Left door with fixing pins	1 pc.
P375000U	Supporting plate with bumpers for Alpha	1 pc.
P8161113U	Folding 120l waste bag holder, with bag retaining hooks, dustpan hook, handle clip, screws and plugs	1 pc.

⚠ ACCESSORIES TO BE ORDERED SEPARATELY

0000AT0120E	Plastic coated bag 120L with grip, grey	1 pc.
00BL1000	Lithium battery	1 pc.





MORGAN HOTEL ELEGANCE

ALPHA HOTEL

EMOTION

KEEPHOTEL

TROLLEYS FOR LAUNDRY
COLLECTION

SILVER

Components for Alpha Hotel trolleys

Short plastic base for Alpha trolley



REF.	NOTES	SIZE (cm) ↓ ↓ ↓
P059011U	with wheels ø 100 mm	66x52
P059031U	with rubber wheels ø 125 mm	66x52
P059061U	with wheels ø 125 mm	66x52
P159061U	with five ø 125 mm wheels	66x52

Long plastic base for Alpha trolley



REF.	NOTES	SIZE (cm) ↓ ↓ ↓
P066011U	with wheels ø 100 mm	91x52
P066031U	with rubber wheels ø 125 mm	91x52
P066061U	with wheels ø 125 mm	91x52
P166031U	with five ø 125 mm rubber wheels	91x52

Base extension for Alpha trolleys and for the bag supporting plastic plate of the Morgan Hotel Elegance trolleys



REF.	NOTES	SIZE (cm) ↓ ↓ ↓
P165000U	without castors	22x48
P065060U	with 2 wheels ø 125 mm	22x48



Supporting plastic plate for Alpha trolleys

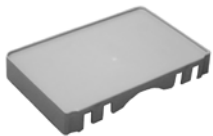

REF.	NOTES	SIZE (cm) ↓ ↓ ↓
P175000U		32x48x7

Vertical frame, 1 side with slides + 1 side for T-plugs, complete with screws and plugs



REF.	NOTES
P2039903E	

Vertical frame, 2 sides with slides, complete with screws and plugs



REF.	NOTES
P2039904E	

Housekeeping trolleys



MORGAN HOTEL ELEGANCE

ALPHA HOTEL

EMOTION

KEEPHOTEL

TROLLEYS FOR LAUNDRY
COLLECTION

SILVER

Reinforced vertical frame, 1 side with slides + 1 side for T-plugs, complete with screws and plugs



REF.	NOTES
P2039908E	

Quick connection kit Link-Up (4 pcs)



REF.	NOTES
0000SM00617	

Set of T-shaped closing plugs for vertical frames (6 pcs)



REF.	NOTES
0000SM00163	dark grey
0000SM00165	light grey

Fixed side wall with fixing pins



REF.	NOTES
P3059953E	

Right door with fixing pins



REF.	NOTES
P3059954E	

Left door with fixing pins



REF.	NOTES
P3059974E	



MORGAN HOTEL ELEGANCE

ALPHA HOTEL

EMOTION

KEEPHOTEL

TROLLEYS FOR LAUNDRY
COLLECTION

SILVER

Right and left wing door set for Apha trolleys



REF.	NOTES
P305997E	

Central plastic basket (female-female version) with plugs



REF.	NOTES
P2199906U	internal sizes 31x48x8 cm

Central plastic basket (male-female version) with screws and plugs



REF.	NOTES
P2199907U	internal sizes 31x48x8 cm

Set with 2 central basket, screws and plugs



REF.	NOTES
P3199908U	

Central basket (female-female version) with divider and plugs



REF.	NOTES
P2199926U	with a grey cover
P2199926UT	with transparent cover
P2199936U	with 2 grey covers
P2199936UT	with 2 transparent covers





MORGAN HOTEL ELEGANCE

ALPHA HOTEL

EMOTION

KEEPHOTEL

TROLLEYS FOR LAUNDRY
COLLECTION

SILVER

Central basket (male-female version) with divider and plugs



REF.	NOTES
P2199927U	with a grey cover
P2199927UT	with transparent cover
P2199937U	with 2 grey covers
P2199937UT	with 2 transparent covers



Set of 2 central baskets with dividers, screws and plugs



REF.	NOTES
P3199928U	with 2 grey covers
P3199938U	with 4 grey covers



Closing profile with push-grip for central basket and central bag holder complete with screws and plugs

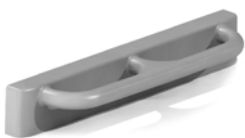

REF.	NOTES
P2909921U	

Folding 120l waste bag holder, with bag retaining hooks, 2 fixed dustpan hooks, 1 handle clip, 2 Uni-Move clips, screws and plugs



REF.	NOTES
P8161113U	
P8161115U	for trolleys with central frame

Set of plastic shelves (2 pcs)



REF.	NOTES	SIZE (cm) ↓ ↓ ↓
P1229900U		21,5x37,5x1,5



MORGAN HOTEL ELEGANCE

ALPHA HOTEL

EMOTION

KEEPHOTEL

TROLLEYS FOR LAUNDRY
COLLECTION

SILVER

Plastic Shelf 46,5x79 cm



REF.	NOTES
P2229911U	

Accessories for Alpha Hotel trolleys

Side plastic basket



REF.	NOTES
P1191100U	internal sizes 22x49x11,5 cm

Bumper set for 120-litre bag holder (no. 1 right bumper + no. 1 left bumper)



REF.	NOTES
000SM00260	

Plastic cover for bag holder 120 L with storage room, check-list holder and lock



REF.	NOTES
P291920UA	
P291920UB	
P291920U	



Please, require also no. 2 shock absorbing pistons art. P190908U for a perfect soft closing

Shock absorbing piston for a soft closing of the cover



REF.	NOTES
P190908U	



Lithium battery for Drive trolleys



REF.	NOTES
00BL1000	



MORGAN HOTEL ELEGANCE

ALPHA HOTEL

EMOTION

KEEPHOTEL

TROLLEYS FOR LAUNDRY COLLECTION

SILVER

Emotion: a new way to communicate through service trolleys

Emotion is Filmop line of trolleys for general and professional cleaning in hotels. Emotion trolleys are **handy, strong**, extremely modular and made of high quality polypropylene materials, from the base to the vertical frames, the shelves and all other accessories. Open or completely closed models are available to guarantee **the highest hygiene** and **the utmost security**. Moreover, thanks to their doors these trolleys always keep a clean and tidy look. Besides their functionality, Emotion trolleys are characterized by a classy, simple and pleasant-looking design, enriched by a **smart graphic layout**. Elegance and style match perfectly together with plainness and efficiency. Thanks to its several components Emotion trolley can be fully accessorized and, consequently, it is ideal for any cleaning need; not only for the change of dirty clean linen, but also for room and bathroom cleaning, for waste collection and mini-bar refilling.

A very close and accurate research and planning have developed a line of trolleys that can be customized with images, special designs, pictures or brands, thus transforming, in a very completely original way, a simple service trolley into an advertising vehicle or into a trolley perfectly fitting the surrounding environment.



Some details about the Emotion line:



Base with 5 rubber wheels Ø 125 mm to increase



Bag holder with bumpers.



Door with locking system with removable key and with ergonomic hand grip



Customizable design

Emotion Drive motor-driven service trolleys



Thanks to the possibility of moving heavy loads without strain, Emotion Drive trolleys **make cleaning easier and quicker**. The range of motor-driven service trolleys makes it possible to tackle all kinds of up or down sloping floors in **full safety** and **without causing disturbance**.

- Loading capacity up to 150 kg
- Freedom of movement with slopes up to 8%
- Adjustable travel speed between 2 and 4.5 km/h
- Intuitive and easy to use console
- Up to 8 hours of use with one charge
- USB mobile phone and tablet charging port

Some features of the Emotion Drive range



Insertion of the key in the console and switching on



FORWARD travel button



REVERSE travel button



STOP button (forward/reverse travel)

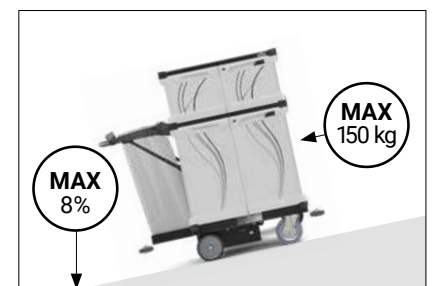



MORGAN HOTEL ELEGANCE

ALPHA HOTEL

EMOTION

KEEPHOTEL

TROLLEYS FOR LAUNDRY
COLLECTION

SILVER

Trolleys with long base

EMOTION 0300020 - plastic trolley



EMOTION 0301020 - plastic trolley

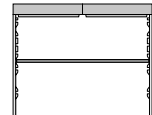

REF.	PCK	VOLUME (m³)	GROSS WEIGHT (kg)	SIZE (cm) ↓ ↓ ↓
SE0300020AE00	1	0,261	29,43	110x64x103,5

REF.	PCK	VOLUME (m³)	GROSS WEIGHT (kg)	SIZE (cm) ↓ ↓ ↓
SE0301020AE00	1	0,31	33,26	154x64x103,5

Suggested for 8 to 10 rooms - Maximum pull-out shelf capacity 30 kg

0000SM00165	Set of T-shaped light grey closing plugs for vertical frames (6 pcs)	2 pcs
P130001Q	Door stopper made of plastic and rubber	1 pc.
P166131Q	Long base with 5 rubber wheels ø 125 mm and bumpers ø 200 mm	1 pc.
P1908839E	Side-walls blocking device	1 pc.
P1918802E	Big fixed side wall	2 pcs
P2038805E	Big vertical frame, 1 side for T-plugs + 1 side with slides, complete with screws	2 pcs
P2229911Q	Long pull-out shelf	1 pc.
P3228800QU	Long smooth fixed shelf with central tray support	1 pc.
P3229915U	Grey pull-out plastic tray with slide out limiter and removable locking key	2 pcs
P3908835Q	Right closing profile with push-grip for Emotion trolleys with door	1 pc.
P3908836Q	Left closing profile with push-grip for Emotion trolleys with door	1 pc.
P3928802E	Big right door with lock and assembling kit	1 pc.
P3938802E	Big left door with assembling kit	1 pc.

Suggested for 8 to 10 rooms - Maximum pull-out shelf capacity 30 kg

0000SM00165	Set of T-shaped light grey closing plugs for vertical frames (6 pcs)	2 pcs
P075130Q	Base extension with rubber wheel ø 125 mm	1 pc.
P130001Q	Door stopper made of plastic and rubber	1 pc.
P166131Q	Long base with 5 rubber wheels ø 125 mm and bumpers ø 200 mm	1 pc.
P1908839E	Side-walls blocking device	1 pc.
P1918802E	Big fixed side wall	2 pcs
P2038805E	Big vertical frame, 1 side for T-plugs + 1 side with slides, complete with screws	2 pcs
P2229911Q	Long pull-out shelf	1 pc.
P3228800QU	Long smooth fixed shelf with central tray support	1 pc.
P3229915U	Grey pull-out plastic tray with slide out limiter and removable locking key	2 pcs
P3908835Q	Right closing profile with push-grip for Emotion trolleys with door	1 pc.
P3928802E	Big right door with lock and assembling kit	1 pc.
P3938802E	Big left door with assembling kit	1 pc.
P8268801Q	Left foldable bag holder 120 L with bumpers for Emotion trolleys with door	1 pc.

⚠ ACCESSORIES TO BE ORDERED SEPARATELY

0000AT0120E	Plastic coated bag 120L with grip, grey	1 pc.
-------------	---	-------



MORGAN HOTEL ELEGANCE

ALPHA HOTEL

EMOTION

KEEPHOTEL

TROLLEYS FOR LAUNDRY
COLLECTION

SILVER

EMOTION 0301021 - plastic trolley



EMOTION 0401021 - plastic trolley



REF.	PCK	VOLUME (m³)	GROSS WEIGHT (kg)	SIZE (cm) ↓ ↓ ↓
SE0301021AE00	1	0,27	30,16	154x64x103,5

Suggested for 8 to 10 rooms - Maximum pull-out shelf capacity 30 kg

0000SM00165	Set of T-shaped light grey closing plugs for vertical frames (6 pcs)	2 pcs
P075130Q	Base extension with rubber wheel ø 125 mm	1 pc.
P130001Q	Door stopper made of plastic and rubber	1 pc.
P166131Q	Long base with 5 rubber wheels ø 125 mm and bumpers ø 200 mm	1 pc.
P1908839E	Side-walls blocking device	1 pc.
P1918802E	Big fixed side wall	2 pcs
P2038805E	Big vertical frame, 1 side for T-plugs + 1 side with slides, complete with screws	2 pcs
P2229911Q	Long pull-out shelf	1 pc.
P3228800QU	Long smooth fixed shelf with central tray support	1 pc.
P3229915U	Grey pull-out plastic tray with slide out limiter and removable locking key	2 pcs
P3908833Q	Right closing profile with push-grip for Emotion trolleys without door	1 pc.
P8268803Q	Left foldable bag holder 120 L with bumpers for Emotion trolleys without door	1 pc.

⚠ ACCESSORIES TO BE ORDERED SEPARATELY

0000AT0120E	Plastic coated bag 120L with grip, grey	1 pc.
-------------	---	-------

REF.	PCK	VOLUME (m³)	GROSS WEIGHT (kg)	SIZE (cm) ↓ ↓ ↓
SE0401021AE00	1	0,31	33,99	154x64x103,5

Suggested for 8 to 10 rooms - Maximum pull-out shelf capacity 15 kg

0000SM00165	Set of T-shaped light grey closing plugs for vertical frames (6 pcs)	2 pcs
P075130Q	Base extension with rubber wheel ø 125 mm	1 pc.
P130001Q	Door stopper made of plastic and rubber	1 pc.
P166131Q	Long base with 5 rubber wheels ø 125 mm and bumpers ø 200 mm	1 pc.
P1918802E	Big fixed side wall	2 pcs
P2038805E	Big vertical frame, 1 side for T-plugs + 1 side with slides, complete with screws	2 pcs
P2229910Q	Small pull-out shelf	2 pcs
P2328801Q	Big fixed shelf with seat for vertical frame	1 pc.
P3038804E	Big vertical frame, 2 sides with slides, complete with screws	1 pc.
P3229915U	Grey pull-out plastic tray with slide out limiter and removable locking key	2 pcs
P3908833Q	Right closing profile with push-grip for Emotion trolleys without door	1 pc.
P8268803Q	Left foldable bag holder 120 L with bumpers for Emotion trolleys without door	1 pc.

⚠ ACCESSORIES TO BE ORDERED SEPARATELY

0000AT0120E	Plastic coated bag 120L with grip, grey	1 pc.
-------------	---	-------



MORGAN HOTEL ELEGANCE

ALPHA HOTEL

EMOTION

KEEPHOTEL

TROLLEYS FOR LAUNDRY
COLLECTION

SILVER

EMOTION 0304020 - plastic trolley

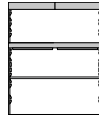

EMOTION 0304004 - plastic trolley



REF.	PCK	VOLUME (m³)	GROSS WEIGHT (kg)	SIZE (cm) ↓ ↓ ↓
SE0304004AE00	1	0,261	33	110x64x142,5

Advised for 10-12 room service - Maximum pull-out shelf capacity 30 kg

REF.	PCK	VOLUME (m³)	GROSS WEIGHT (kg)	SIZE (cm) ↓ ↓ ↓
SE0304020AE00	1	0,31	39,77	110x64x142,5

Advised for 10-12 room service - Maximum pull-out shelf capacity 30 kg

0000SM00165	Set of T-shaped light grey closing plugs for vertical frames (6 pcs)	2 pcs
P130001Q	Door stopper made of plastic and rubber	1 pc.
P166131Q	Long base with 5 rubber wheels ø 125 mm and bumpers ø 200 mm	1 pc.
P1908839E	Side-walls blocking device	1 pc.
P1918802E	Big fixed side wall	2 pcs
P1948802E	Small fixed side wall	2 pcs
P2038805E	Big vertical frame, 1 side for T-plugs + 1 side with slides, complete with screws	2 pcs
P2038806E	Small vertical frame, 1 smooth side + 1 side with slides	2 pcs
P2228800Q	Long smooth fixed shelf	1 pc.
P2229911Q	Long pull-out shelf	1 pc.
P2908822Q	Right closing profile for Emotion trolleys with door	1 pc.
P2908823Q	Left closing profile for Emotion trolleys with door	1 pc.
P3228800QU	Long smooth fixed shelf with central tray support	1 pc.
P3229915U	Grey pull-out plastic tray with slide out limiter and removable locking key	2 pcs
P3908835Q	Right closing profile with push-grip for Emotion trolleys with door	1 pc.
P3908836Q	Left closing profile with push-grip for Emotion trolleys with door	1 pc.
P3928802E	Big right door with lock and assembling kit	1 pc.
P3938802E	Big left door with assembling kit	1 pc.
P3958802E	Small right door with lock and assembling kit	1 pc.
P3968802E	Small left door with assembling kit	1 pc.

0000SM00165	Set of T-shaped light grey closing plugs for vertical frames (6 pcs)	2 pcs
P130001Q	Door stopper made of plastic and rubber	1 pc.
P166131Q	Long base with 5 rubber wheels ø 125 mm and bumpers ø 200 mm	1 pc.
P2038805E	Big vertical frame, 1 side for T-plugs + 1 side with slides, complete with screws	2 pcs
P2038806E	Small vertical frame, 1 smooth side + 1 side with slides	2 pcs
P2228800Q	Long smooth fixed shelf	1 pc.
P2229911Q	Long pull-out shelf	1 pc.
P2908820Q	Right closing profile for Emotion trolleys without door	1 pc.
P2908821Q	Left closing profile for Emotion trolleys without door	1 pc.
P3228800QU	Long smooth fixed shelf with central tray support	1 pc.
P3229915U	Grey pull-out plastic tray with slide out limiter and removable locking key	2 pcs
P3908833Q	Right closing profile with push-grip for Emotion trolleys without door	1 pc.
P3908834Q	Left closing profile with push-grip for Emotion trolleys without door	1 pc.



MORGAN HOTEL ELEGANCE

ALPHA HOTEL

EMOTION

KEEPHOTEL

TROLLEYS FOR LAUNDRY
COLLECTION

SILVER

EMOTION 0404021 - plastic trolley



EMOTION 0305020 - plastic trolley



REF.	PCK	VOLUME (m³)	GROSS WEIGHT (kg)	SIZE (cm) ↓ ↓ ↓
SE0404021AE00	1	0,372	37,97	110x64x142,5

Advised for 10-12 room service - Maximum pull-out shelf capacity 15 kg

0000SM00165	Set of T-shaped light grey closing plugs for vertical frames (6 pcs)	2 pcs
P130001Q	Door stopper made of plastic and rubber	1 pc.
P166131Q	Long base with 5 rubber wheels ø 125 mm and bumpers ø 200 mm	1 pc.
P1918802E	Big fixed side wall	2 pcs
P1948802E	Small fixed side wall	2 pcs
P2038805E	Big vertical frame, 1 side for T-plugs + 1 side with slides, complete with screws	2 pcs
P2038806E	Small vertical frame, 1 smooth side + 1 side with slides	2 pcs
P2038807E	Small vertical frame, 2 sides with slides	1 pc.
P2229910Q	Small pull-out shelf	2 pcs
P2328801Q	Big fixed shelf with seat for vertical frame	2 pcs
P2908820Q	Right closing profile for Emotion trolleys without door	1 pc.
P2908821Q	Left closing profile for Emotion trolleys without door	1 pc.
P3038804E	Big vertical frame, 2 sides with slides, complete with screws	1 pc.
P3229915U	Grey pull-out plastic tray with slide out limiter and removable locking key	2 pcs
P3908833Q	Right closing profile with push-grip for Emotion trolleys without door	1 pc.
P3908834Q	Left closing profile with push-grip for Emotion trolleys without door	1 pc.

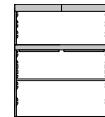

REF.	PCK	VOLUME (m³)	GROSS WEIGHT (kg)	SIZE (cm) ↓ ↓ ↓
SE0305020AE00	1	0,438	40,87	154x64x142,5

Advised for 10-12 room service - Maximum pull-out shelf capacity 30 kg

0000SM00165	Set of T-shaped light grey closing plugs for vertical frames (6 pcs)	2 pcs
P075130Q	Base extension with rubber wheel ø 125 mm	1 pc.
P130001Q	Door stopper made of plastic and rubber	1 pc.
P166131Q	Long base with 5 rubber wheels ø 125 mm and bumpers ø 200 mm	1 pc.
P1908839E	Side-walls blocking device	1 pc.
P1918802E	Big fixed side wall	2 pcs
P1948802E	Small fixed side wall	2 pcs
P2038805E	Big vertical frame, 1 side for T-plugs + 1 side with slides, complete with screws	2 pcs
P2038806E	Small vertical frame, 1 smooth side + 1 side with slides	2 pcs
P2228800Q	Long smooth fixed shelf	1 pc.
P2229911Q	Long pull-out shelf	1 pc.
P2908822Q	Right closing profile for Emotion trolleys with door	1 pc.
P2908823Q	Left closing profile for Emotion trolleys with door	1 pc.
P3228800QU	Long smooth fixed shelf with central tray support	1 pc.
P3229915U	Grey pull-out plastic tray with slide out limiter and removable locking key	2 pcs
P3908835Q	Right closing profile with push-grip for Emotion trolleys with door	1 pc.
P3928802E	Big right door with lock and assembling kit	1 pc.
P3938802E	Big left door with assembling kit	1 pc.
P3958802E	Small right door with lock and assembling kit	1 pc.
P3968802E	Small left door with assembling kit	1 pc.
P8268801Q	Left foldable bag holder 120 L with bumpers for Emotion trolleys with door	1 pc.

⚠ ACCESSORIES TO BE ORDERED SEPARATELY

0000AT0120E	Plastic coated bag 120L with grip, grey	1 pc.
-------------	---	-------



MORGAN HOTEL ELEGANCE

ALPHA HOTEL

EMOTION

KEEPHOTEL

TROLLEYS FOR LAUNDRY
COLLECTION

SILVER

EMOTION 0305021 - plastic trolley



EMOTION 0505021 - plastic trolley



REF.	PCK	VOLUME (m³)	GROSS WEIGHT (kg)	SIZE (cm) ↓ ↓ ↓
SE0305021AE00	1	0,372	38,63	154x64x142,5

REF.	PCK	VOLUME (m³)	GROSS WEIGHT (kg)	SIZE (cm) ↓ ↓ ↓
SE0505021AE06	1	0,438	44,96	154x64x142,5

Advised for 10-12 room service - Maximum pull-out shelf capacity 30 kg

Advised for 10-12 room service - Maximum pull-out shelf capacity big 30 kg, small 15 kg

0000SM00165	Set of T-shaped light grey closing plugs for vertical frames (6 pcs)	2 pcs
P075130Q	Base extension with rubber wheel ø 125 mm	1 pc.
P130001Q	Door stopper made of plastic and rubber	1 pc.
P166131Q	Long base with 5 rubber wheels ø 125 mm and bumpers ø 200 mm	1 pc.
P1908839E	Side-walls blocking device	1 pc.
P1918802E	Big fixed side wall	2 pcs
P1948802E	Small fixed side wall	2 pcs
P2038805E	Big vertical frame, 1 side for T-plugs + 1 side with slides, complete with screws	2 pcs
P2038806E	Small vertical frame, 1 smooth side + 1 side with slides	2 pcs
P2228800Q	Long smooth fixed shelf	1 pc.
P2229911Q	Long pull-out shelf	1 pc.
P2908820Q	Right closing profile for Emotion trolleys without door	1 pc.
P2908821Q	Left closing profile for Emotion trolleys without door	1 pc.
P3228800QU	Long smooth fixed shelf with central tray support	1 pc.
P3229915U	Grey pull-out plastic tray with slide out limiter and removable locking key	2 pcs
P3908833Q	Right closing profile with push-grip for Emotion trolleys without door	1 pc.
P8268803Q	Left foldable bag holder 120 L with bumpers for Emotion trolleys without door	1 pc.

0000SM00165	Set of T-shaped light grey closing plugs for vertical frames (6 pcs)	2 pcs
P075130Q	Base extension with rubber wheel ø 125 mm	1 pc.
P130001Q	Door stopper made of plastic and rubber	1 pc.
P166131Q	Long base with 5 rubber wheels ø 125 mm and bumpers ø 200 mm	1 pc.
P1908839E	Side-walls blocking device	1 pc.
P1918802E	Big fixed side wall	2 pcs
P1948802E	Small fixed side wall	2 pcs
P2038805E	Big vertical frame, 1 side for T-plugs + 1 side with slides, complete with screws	2 pcs
P2038806E	Small vertical frame, 1 smooth side + 1 side with slides	2 pcs
P2038807E	Small vertical frame, 2 sides with slides	1 pc.
P2229909U	Plastic sliding drawer 10 L with lock	3 pcs
P2229910Q	Small pull-out shelf	1 pc.
P2229911Q	Long pull-out shelf	1 pc.
P2328801Q	Big fixed shelf with seat for vertical frame	1 pc.
P2908820Q	Right closing profile for Emotion trolleys without door	1 pc.
P2908821Q	Left closing profile for Emotion trolleys without door	1 pc.
P3228801QU	Long fixed shelf with seat for vertical frame and central tray support	1 pc.
P3229915U	Grey pull-out plastic tray with slide out limiter and removable locking key	2 pcs
P3908833Q	Right closing profile with push-grip for Emotion trolleys without door	1 pc.
P8268803Q	Left foldable bag holder 120 L with bumpers for Emotion trolleys without door	1 pc.

⚠ ACCESSORIES TO BE ORDERED SEPARATELY

0000AT0120E	Plastic coated bag 120L with grip, grey	1 pc.
-------------	---	-------

⚠ ACCESSORIES TO BE ORDERED SEPARATELY

0000AT0120E	Plastic coated bag 120L with grip, grey	1 pc.
-------------	---	-------



MORGAN HOTEL ELEGANCE

ALPHA HOTEL

EMOTION

KEEPHOTEL

TROLLEYS FOR LAUNDRY
COLLECTION

SILVER

EMOTION 0605021 - plastic trolley



EMOTION 0306020 - plastic trolley



REF.	PCK	VOLUME (m³)	GROSS WEIGHT (kg)	SIZE (cm) ↓ ↓ ↓
SE0605021AE00	1	0,372	39,57	154x64x142,5

Advised for 10-12 room service - Maximum pull-out shelf capacity 15 kg

0000SM00165	Set of T-shaped light grey closing plugs for vertical frames (6 pcs)	2 pcs
P075130Q	Base extension with rubber wheel ø 125 mm	1 pc.
P130001Q	Door stopper made of plastic and rubber	1 pc.
P166131Q	Long base with 5 rubber wheels ø 125 mm and bumpers ø 200 mm	1 pc.
P1918802E	Big fixed side wall	2 pcs
P1948802E	Small fixed side wall	2 pcs
P2038805E	Big vertical frame, 1 side for T-plugs + 1 side with slides, complete with screws	2 pcs
P2038806E	Small vertical frame, 1 smooth side + 1 side with slides	2 pcs
P2228800Q	Long smooth fixed shelf	1 pc.
P2229910Q	Small pull-out shelf	2 pcs
P2328801Q	Big fixed shelf with seat for vertical frame	1 pc.
P2908820Q	Right closing profile for Emotion trolleys without door	1 pc.
P2908821Q	Left closing profile for Emotion trolleys without door	1 pc.
P3038804E	Big vertical frame, 2 sides with slides, complete with screws	1 pc.
P3229915U	Grey pull-out plastic tray with slide out limiter and removable locking key	2 pcs
P3908833Q	Right closing profile with push-grip for Emotion trolleys without door	1 pc.
P8268803Q	Left foldable bag holder 120 L with bumpers for Emotion trolleys without door	1 pc.

⚠ ACCESSORIES TO BE ORDERED SEPARATELY

0000AT0120E	Plastic coated bag 120L with grip, grey	1 pc.
-------------	---	-------

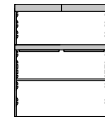

REF.	PCK	VOLUME (m³)	GROSS WEIGHT (kg)	SIZE (cm) ↓ ↓ ↓
SE0306020AE00	1	0,487	54,07	197x64x142,5

Advised for 10-12 room service - Maximum pull-out shelf capacity 30 kg

0000SM00165	Set of T-shaped light grey closing plugs for vertical frames (6 pcs)	2 pcs
P075130Q	Base extension with rubber wheel ø 125 mm	2 pcs
P130001Q	Door stopper made of plastic and rubber	1 pc.
P166131Q	Long base with 5 rubber wheels ø 125 mm and bumpers ø 200 mm	1 pc.
P1908839E	Side-walls blocking device	1 pc.
P1918802E	Big fixed side wall	2 pcs
P1948802E	Small fixed side wall	2 pcs
P2038805E	Big vertical frame, 1 side for T-plugs + 1 side with slides, complete with screws	2 pcs
P2038806E	Small vertical frame, 1 smooth side + 1 side with slides	2 pcs
P2228800Q	Long smooth fixed shelf	1 pc.
P2229911Q	Long pull-out shelf	1 pc.
P2908822Q	Right closing profile for Emotion trolleys with door	1 pc.
P2908823Q	Left closing profile for Emotion trolleys with door	1 pc.
P3228800QU	Long smooth fixed shelf with central tray support	1 pc.
P3229915U	Grey pull-out plastic tray with slide out limiter and removable locking key	2 pcs
P3928802E	Big right door with lock and assembling kit	1 pc.
P3938802E	Big left door with assembling kit	1 pc.
P3958802E	Small right door with lock and assembling kit	1 pc.
P3968802E	Small left door with assembling kit	1 pc.
P8268800Q	Right foldable bag holder 120 L with bumpers for Emotion trolleys with door	1 pc.
P8268801Q	Left foldable bag holder 120 L with bumpers for Emotion trolleys with door	1 pc.

⚠ ACCESSORIES TO BE ORDERED SEPARATELY

0000AT0120E	Plastic coated bag 120L with grip, grey	2 pcs
-------------	---	-------



MORGAN HOTEL ELEGANCE

ALPHA HOTEL

EMOTION

KEEPHOTEL

TROLLEYS FOR LAUNDRY
COLLECTION

SILVER

EMOTION 0306021 - plastic trolley



EMOTION 0506021 - plastic trolley



REF.	PCK	VOLUME (m³)	GROSS WEIGHT (kg)	SIZE (cm) ↓ ↓ ↓
SE0306021AE00	1	0,372	42,87	197x64x142,5

Advised for 10-12 room service - Maximum pull-out shelf capacity 30 kg

0000SM00165	Set of T-shaped light grey closing plugs for vertical frames (6 pcs)	2 pcs
P075130Q	Base extension with rubber wheel ø 125 mm	2 pcs
P130001Q	Door stopper made of plastic and rubber	1 pc.
P166131Q	Long base with 5 rubber wheels ø 125 mm and bumpers ø 200 mm	1 pc.
P1908839E	Side-walls blocking device	1 pc.
P1918802E	Big fixed side wall	2 pcs
P1948802E	Small fixed side wall	2 pcs
P2038805E	Big vertical frame, 1 side for T-plugs + 1 side with slides, complete with screws	2 pcs
P2038806E	Small vertical frame, 1 smooth side + 1 side with slides	2 pcs
P2228800Q	Long smooth fixed shelf	1 pc.
P2229911Q	Long pull-out shelf	1 pc.
P2908820Q	Right closing profile for Emotion trolleys without door	1 pc.
P2908821Q	Left closing profile for Emotion trolleys without door	1 pc.
P3228800QU	Long smooth fixed shelf with central tray support	1 pc.
P3229915U	Grey pull-out plastic tray with slide out limiter and removable locking key	2 pcs
P8268802Q	Right foldable bag holder 120 L with bumpers for Emotion trolleys without door	1 pc.
P8268803Q	Left foldable bag holder 120 L with bumpers for Emotion trolleys without door	1 pc.

⚠ ACCESSORIES TO BE ORDERED SEPARATELY

0000AT0120E	Plastic coated bag 120L with grip, grey	2 pcs
-------------	---	-------

REF.	PCK	VOLUME (m³)	GROSS WEIGHT (kg)	SIZE (cm) ↓ ↓ ↓
SE0506021AE00	1	0,448	41,6	197x64x142,5

Advised for 10-12 room service - Maximum pull-out shelf capacity 30 kg

0000SM00165	Set of T-shaped light grey closing plugs for vertical frames (6 pcs)	2 pcs
P075130Q	Base extension with rubber wheel ø 125 mm	2 pcs
P130001Q	Door stopper made of plastic and rubber	1 pc.
P166131Q	Long base with 5 rubber wheels ø 125 mm and bumpers ø 200 mm	1 pc.
P1908839E	Side-walls blocking device	1 pc.
P1918802E	Big fixed side wall	2 pcs
P1948802E	Small fixed side wall	2 pcs
P2038805E	Big vertical frame, 1 side for T-plugs + 1 side with slides, complete with screws	2 pcs
P2038806E	Small vertical frame, 1 smooth side + 1 side with slides	2 pcs
P2038807E	Small vertical frame, 2 sides with slides	1 pc.
P2229911Q	Long pull-out shelf	1 pc.
P2328801Q	Big fixed shelf with seat for vertical frame	1 pc.
P2908820Q	Right closing profile for Emotion trolleys without door	1 pc.
P2908821Q	Left closing profile for Emotion trolleys without door	1 pc.
P3228801QU	Long fixed shelf with seat for vertical frame and central tray support	1 pc.
P3229915U	Grey pull-out plastic tray with slide out limiter and removable locking key	2 pcs
P8268802Q	Right foldable bag holder 120 L with bumpers for Emotion trolleys without door	1 pc.
P8268803Q	Left foldable bag holder 120 L with bumpers for Emotion trolleys without door	1 pc.

⚠ ACCESSORIES TO BE ORDERED SEPARATELY

0000AT0120E	Plastic coated bag 120L with grip, grey	2 pcs
-------------	---	-------



MORGAN HOTEL ELEGANCE

ALPHA HOTEL

EMOTION

KEEPHOTEL

TROLLEYS FOR LAUNDRY
COLLECTION

SILVER

EMOTION 0317020 - plastic trolley

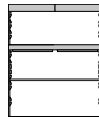

REF.	PCK	VOLUME (m³)	GROSS WEIGHT (kg)	SIZE (cm) ↓ ↓ ↓
SE0317020AE00	1	0,438	50,46	175x64x142,5

Advised for 10-12 room service - Maximum pull-out shelf capacity 30 kg

0000SM00165	Set of T-shaped light grey closing plugs for vertical frames (6 pcs)	2 pcs
P075130Q	Base extension with rubber wheel ø 125 mm	2 pcs
P130001Q	Door stopper made of plastic and rubber	1 pc.
P166131Q	Long base with 5 rubber wheels ø 125 mm and bumpers ø 200 mm	1 pc.
P1908839E	Side-walls blocking device	1 pc.
P1918802E	Big fixed side wall	2 pcs
P1948802E	Small fixed side wall	2 pcs
P2038805E	Big vertical frame, 1 side for T-plugs + 1 side with slides, complete with screws	2 pcs
P2038806E	Small vertical frame, 1 smooth side + 1 side with slides	2 pcs
P2228800Q	Long smooth fixed shelf	1 pc.
P2229911Q	Long pull-out shelf	1 pc.
P2908822Q	Right closing profile for Emotion trolleys with door	2 pcs
P2908823Q	Left closing profile for Emotion trolleys with door	1 pc.
P3228800QU	Long smooth fixed shelf with central tray support	1 pc.
P3229915U	Grey pull-out plastic tray with slide out limiter and removable locking key	2 pcs
P3928802E	Big right door with lock and assembling kit	1 pc.
P3938802E	Big left door with assembling kit	1 pc.
P3958802E	Small right door with lock and assembling kit	1 pc.
P3968802E	Small left door with assembling kit	1 pc.
P8268801Q	Left foldable bag holder 120 L with bumpers for Emotion trolleys with door	1 pc.
R2180085	Rilsan coated support for vacuum cleaner that can be assembled to the vertical frame of the Emotion trolleys	1 pc.

⚠ ACCESSORIES TO BE ORDERED SEPARATELY

0000AT0120E	Plastic coated bag 120L with grip, grey	1 pc.
-------------	---	-------

EMOTION 0318021 - plastic trolley



REF.	PCK	VOLUME (m³)	GROSS WEIGHT (kg)	SIZE (cm) ↓ ↓ ↓
SE0318021AE00	1	0,372	48,17	175x64x142,5

Advised for 10-12 room service - Maximum pull-out shelf capacity 30 kg

0000SM00165	Set of T-shaped light grey closing plugs for vertical frames (6 pcs)	2 pcs
P075130Q	Base extension with rubber wheel ø 125 mm	2 pcs
P130001Q	Door stopper made of plastic and rubber	1 pc.
P166131Q	Long base with 5 rubber wheels ø 125 mm and bumpers ø 200 mm	1 pc.
P1908839E	Side-walls blocking device	1 pc.
P1918802E	Big fixed side wall	2 pcs
P1948802E	Small fixed side wall	2 pcs
P2038805E	Big vertical frame, 1 side for T-plugs + 1 side with slides, complete with screws	2 pcs
P2038806E	Small vertical frame, 1 smooth side + 1 side with slides	2 pcs
P2228800Q	Long smooth fixed shelf	1 pc.
P2229911Q	Long pull-out shelf	1 pc.
P2908820Q	Right closing profile for Emotion trolleys without door	2 pcs
P2908821Q	Left closing profile for Emotion trolleys without door	1 pc.
P3228800QU	Long smooth fixed shelf with central tray support	1 pc.
P3229915U	Grey pull-out plastic tray with slide out limiter and removable locking key	2 pcs
P8268803Q	Left foldable bag holder 120 L with bumpers for Emotion trolleys without door	1 pc.
Q1400123E	Emotion trolley bathrobe and/or towel holder kit for Emotion trolleys	1 pc.

⚠ ACCESSORIES TO BE ORDERED SEPARATELY

0000AT0120E	Plastic coated bag 120L with grip, grey	1 pc.
-------------	---	-------



MORGAN HOTEL ELEGANCE

ALPHA HOTEL

EMOTION

KEEPHOTEL

TROLLEYS FOR LAUNDRY
COLLECTION

SILVER

Trolleys with short base

EMOTION 0316020 - plastic trolley



EMOTION 0105020 - plastic trolley



REF.	PCK	VOLUME (m³)	GROSS WEIGHT (kg)	SIZE (cm) ↓ ↓ ↓
SE0316020AE00	1	0,438	48	138x64x142,5

REF.	PCK	VOLUME (m³)	GROSS WEIGHT (kg)	SIZE (cm) ↓ ↓ ↓
SE0105020AE00	1	0,31	31,47	110x64x142,5

Advised for 10-12 room service - Maximum pull-out shelf capacity 30 kg

0000SE1222U	Plastic bucket 20L with plastic handle, grey	1 pc.
0000SE1322U	TOP-DOWN - plastic bucket with plastic handle and watertight lid, 20 l, grey	1 pc.
0000SM00165	Set of T-shaped light grey closing plugs for vertical frames (6 pcs)	2 pcs
P130001Q	Door stopper made of plastic and rubber	1 pc.
P165000Q	Supporting plate fitting the base of Emotion trolleys	2 pcs
P166131Q	Long base with 5 rubber wheels ø 125 mm and bumpers ø 200 mm	1 pc.
P1908839E	Side-walls blocking device	1 pc.
P1918802E	Big fixed side wall	2 pcs
P1948802E	Small fixed side wall	2 pcs
P2038805E	Big vertical frame, 1 side for T-plugs + 1 side with slides, complete with screws	2 pcs
P2038806E	Small vertical frame, 1 smooth side + 1 side with slides	2 pcs
P2228800Q	Long smooth fixed shelf	1 pc.
P2229911Q	Long pull-out shelf	1 pc.
P2908822Q	Right closing profile for Emotion trolleys with door	1 pc.
P2908823Q	Left closing profile for Emotion trolleys with door	1 pc.
P3228800QU	Long smooth fixed shelf with central tray support	1 pc.
P3229915U	Grey pull-out plastic tray with slide out limiter and removable locking key	2 pcs
P3908835Q	Right closing profile with push-grip for Emotion trolleys with door	1 pc.
P3908836Q	Left closing profile with push-grip for Emotion trolleys with door	1 pc.
P3928802E	Big right door with lock and assembling kit	1 pc.
P3938802E	Big left door with assembling kit	1 pc.
P3958802E	Small right door with lock and assembling kit	1 pc.
P3968802E	Small left door with assembling kit	1 pc.

Suggested for 6 to 8 rooms - Maximum pull-out shelf capacity 15 kg

0000SM00165	Set of T-shaped light grey closing plugs for vertical frames (6 pcs)	2 pcs
P1228802Q	Small fixed shelf (female-female version)	2 pcs
P130001Q	Door stopper made of plastic and rubber	1 pc.
P159131Q	Short base with 5 rubber wheels ø 125 mm and bumpers ø 200 mm	1 pc.
P165000Q	Supporting plate fitting the base of Emotion trolleys	1 pc.
P1918802E	Big fixed side wall	1 pc.
P1948802E	Small fixed side wall	1 pc.
P2038805E	Big vertical frame, 1 side for T-plugs + 1 side with slides, complete with screws	2 pcs
P2038806E	Small vertical frame, 1 smooth side + 1 side with slides	2 pcs
P2229910Q	Small pull-out shelf	1 pc.
P2908821Q	Left closing profile for Emotion trolleys without door	1 pc.
P2908822Q	Right closing profile for Emotion trolleys with door	1 pc.
P3229915U	Grey pull-out plastic tray with slide out limiter and removable locking key	1 pc.
P3908835Q	Right closing profile with push-grip for Emotion trolleys with door	1 pc.
P3928802E	Big right door with lock and assembling kit	1 pc.
P3958802E	Small right door with lock and assembling kit	1 pc.
P8268803Q	Left foldable bag holder 120 L with bumpers for Emotion trolleys without door	1 pc.

⚠ ACCESSORIES TO BE ORDERED SEPARATELY

0000AT0120E	Plastic coated bag 120L with grip, grey	1 pc.
-------------	---	-------

Housekeeping trolleys



MORGAN HOTEL ELEGANCE

ALPHA HOTEL

EMOTION

KEEPHOTEL

TROLLEYS FOR LAUNDRY
COLLECTION

SILVER

EMOTION 0105021 - plastic trolley



EMOTION 0106020 - plastic trolley



REF.	PCK	VOLUME (m³)	GROSS WEIGHT (kg)	SIZE (cm) ↓ ↓ ↓
SE0105021AE00	1	0,261	28,6	110x64x142,5

Suggested for 6 to 8 rooms - Maximum pull-out shelf capacity 15 kg

0000SM00165	Set of T-shaped light grey closing plugs for vertical frames (6 pcs)	2 pcs
P1228802Q	Small fixed shelf (female-female version)	2 pcs
P130001Q	Door stopper made of plastic and rubber	1 pc.
P159131Q	Short base with 5 rubber wheels ø 125 mm and bumpers ø 200 mm	1 pc.
P165000Q	Supporting plate fitting the base of Emotion trolleys	1 pc.
P1918802E	Big fixed side wall	1 pc.
P1948802E	Small fixed side wall	1 pc.
P2038805E	Big vertical frame, 1 side for T-plugs + 1 side with slides, complete with screws	2 pcs
P2038806E	Small vertical frame, 1 smooth side + 1 side with slides	2 pcs
P2229910Q	Small pull-out shelf	1 pc.
P2908820Q	Right closing profile for Emotion trolleys without door	1 pc.
P2908821Q	Left closing profile for Emotion trolleys without door	1 pc.
P3229915U	Grey pull-out plastic tray with slide out limiter and removable locking key	1 pc.
P3908833Q	Right closing profile with push-grip for Emotion trolleys without door	1 pc.
P8268803Q	Left foldable bag holder 120 L with bumpers for Emotion trolleys without door	1 pc.

⚠ ACCESSORIES TO BE ORDERED SEPARATELY

0000AT0120E	Plastic coated bag 120L with grip, grey	1 pc.
-------------	---	-------

REF.	PCK	VOLUME (m³)	GROSS WEIGHT (kg)	SIZE (cm) ↓ ↓ ↓
SE0106020AE00	1	0,31	35,06	159x64x142,5

Suggested for 6 to 8 rooms - Maximum pull-out shelf capacity 15 kg

0000SM00165	Set of T-shaped light grey closing plugs for vertical frames (6 pcs)	2 pcs
P075130Q	Base extension with rubber wheel ø 125 mm	1 pc.
P1228802Q	Small fixed shelf (female-female version)	2 pcs
P130001Q	Door stopper made of plastic and rubber	1 pc.
P159131Q	Short base with 5 rubber wheels ø 125 mm and bumpers ø 200 mm	1 pc.
P165000Q	Supporting plate fitting the base of Emotion trolleys	1 pc.
P1918802E	Big fixed side wall	1 pc.
P1948802E	Small fixed side wall	1 pc.
P2038805E	Big vertical frame, 1 side for T-plugs + 1 side with slides, complete with screws	2 pcs
P2038806E	Small vertical frame, 1 smooth side + 1 side with slides	2 pcs
P2229910Q	Small pull-out shelf	1 pc.
P2908821Q	Left closing profile for Emotion trolleys without door	1 pc.
P2908822Q	Right closing profile for Emotion trolleys with door	1 pc.
P3229915U	Grey pull-out plastic tray with slide out limiter and removable locking key	1 pc.
P3928802E	Big right door with lock and assembling kit	1 pc.
P3958802E	Small right door with lock and assembling kit	1 pc.
P8268800Q	Right foldable bag holder 120 L with bumpers for Emotion trolleys with door	1 pc.
P8268803Q	Left foldable bag holder 120 L with bumpers for Emotion trolleys without door	1 pc.

⚠ ACCESSORIES TO BE ORDERED SEPARATELY

0000AT0120E	Plastic coated bag 120L with grip, grey	2 pcs
-------------	---	-------



MORGAN HOTEL ELEGANCE

ALPHA HOTEL

EMOTION

KEEPHOTEL

TROLLEYS FOR LAUNDRY
COLLECTION

SILVER

EMOTION 0000020 - plastic trolley

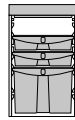

EMOTION 0104020 - plastic trolley



REF.	PCK	VOLUME (m³)	GROSS WEIGHT (kg)	SIZE (cm) ↓ ↓ ↓
SE0000020AE01	1	0,27	27,47	65x64x103,5

Suggested for the mini bar refilling

0000SM00165	Set of T-shaped light grey closing plugs for vertical frames (6 pcs)	2 pcs
P025131Q	Compact base with 4 wheels ø 125 mm and bumpers ø 200	1 pc.
P1228802Q	Small fixed shelf (female-female version)	1 pc.
P1229907U	Gray plastic drawer 40 L without key	1 pc.
P1229909U	Plastic sliding drawer 10 L without locking key	2 pcs
P130001Q	Door stopper made of plastic and rubber	1 pc.
P1918802E	Big fixed side wall	1 pc.
P2038805E	Big vertical frame, 1 side for T-plugs + 1 side with slides, complete with screws	2 pcs
P2908821Q	Left closing profile for Emotion trolleys without door	1 pc.
P3908835Q	Right closing profile with push-grip for Emotion trolleys with door	1 pc.
P3928802E	Big right door with lock and assembling kit	1 pc.

REF.	PCK	VOLUME (m³)	GROSS WEIGHT (kg)	SIZE (cm) ↓ ↓ ↓
SE0104020AE01	1	0,372	31,67	81x64x142,5

Suggested for the mini bar refilling

0000SM00165	Set of T-shaped light grey closing plugs for vertical frames (6 pcs)	2 pcs
P1228802Q	Small fixed shelf (female-female version)	2 pcs
P1229907U	Gray plastic drawer 40 L without key	1 pc.
P1229909U	Plastic sliding drawer 10 L without locking key	2 pcs
P130001Q	Door stopper made of plastic and rubber	1 pc.
P159131Q	Short base with 5 rubber wheels ø 125 mm and bumpers ø 200 mm	1 pc.
P1918802E	Big fixed side wall	1 pc.
P1948802E	Small fixed side wall	1 pc.
P2038805E	Big vertical frame, 1 side for T-plugs + 1 side with slides, complete with screws	2 pcs
P2038806E	Small vertical frame, 1 smooth side + 1 side with slides	2 pcs
P2229910Q	Small pull-out shelf	1 pc.
P2908821Q	Left closing profile for Emotion trolleys without door	2 pcs
P2908822Q	Right closing profile for Emotion trolleys with door	1 pc.
P3908835Q	Right closing profile with push-grip for Emotion trolleys with door	1 pc.
P3928802E	Big right door with lock and assembling kit	1 pc.
P3958802E	Small right door with lock and assembling kit	1 pc.



MORGAN HOTEL ELEGANCE

ALPHA HOTEL

EMOTION

KEEPHOTEL

TROLLEYS FOR LAUNDRY
COLLECTION

SILVER

Emotion Drive

EMOTION DRIVE 0400020PE - plastic trolley

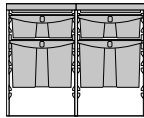

EMOTION DRIVE 0304020PE - plastic trolley

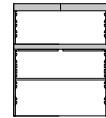

REF.	PCK	VOLUME (m³)	GROSS WEIGHT (kg)	SIZE (cm) ↓ ↓ ↓
SE0400020PE02	1	1,71	72,7	110x64x110,5

REF.	PCK	VOLUME (m³)	GROSS WEIGHT (kg)	SIZE (cm) ↓ ↓ ↓
SE0304020PE00	1	1,71	77	110x64x149,5

Suggested for 8 to 10 rooms

0000SM00165	Set of T-shaped light grey closing plugs for vertical frames (6 pcs)	2 pcs
P1229906U	Grey plastic drawer 22 L without key	2 pcs
P1229907U	Gray plastic drawer 40 L without key	2 pcs
P130001Q	Door stopper made of plastic and rubber	1 pc.
P1918802E	Big fixed side wall	2 pcs
P2038805E	Big vertical frame, 1 side for T-plugs + 1 side with slides, complete with screws	2 pcs
P2328801Q	Big fixed shelf with seat for vertical frame	1 pc.
P266481Q	Long base with 2 rubber wheels ø 200x50 mm and 4 bumpers complete with motor kit	1 pc.
P3038804E	Big vertical frame, 2 sides with slides, complete with screws	1 pc.
P3229915U	Grey pull-out plastic tray with slide out limiter and removable locking key	2 pcs
P3908836Q	Left closing profile with push-grip for Emotion trolleys with door	1 pc.
P3928802E	Big right door with lock and assembling kit	1 pc.
P3938802E	Big left door with assembling kit	1 pc.
P4908835Q	Closing profile with right push-grip, complete with plate for console for trolleys with door	1 pc.

⚠ ACCESSORIES TO BE ORDERED SEPARATELY

00BL1000	Lithium battery	1 pc.
----------	-----------------	-------

Advised for 10-12 room service - Maximum pull-out shelf capacity 30 kg

0000SM00165	Set of T-shaped light grey closing plugs for vertical frames (6 pcs)	2 pcs
P130001Q	Door stopper made of plastic and rubber	1 pc.
P1908839E	Side-walls blocking device	1 pc.
P1918802E	Big fixed side wall	2 pcs
P1948802E	Small fixed side wall	2 pcs
P2038805E	Big vertical frame, 1 side for T-plugs + 1 side with slides, complete with screws	2 pcs
P2038806E	Small vertical frame, 1 smooth side + 1 side with slides	2 pcs
P2228800Q	Long smooth fixed shelf	1 pc.
P2229911Q	Long pull-out shelf	1 pc.
P266481Q	Long base with 2 rubber wheels ø 200x50 mm and 4 bumpers complete with motor kit	1 pc.
P2908822Q	Right closing profile for Emotion trolleys with door	1 pc.
P2908823Q	Left closing profile for Emotion trolleys with door	1 pc.
P3228800QU	Long smooth fixed shelf with central tray support	1 pc.
P3229915U	Grey pull-out plastic tray with slide out limiter and removable locking key	2 pcs
P3908836Q	Left closing profile with push-grip for Emotion trolleys with door	1 pc.
P3928802E	Big right door with lock and assembling kit	1 pc.
P3938802E	Big left door with assembling kit	1 pc.
P3958802E	Small right door with lock and assembling kit	1 pc.
P3968802E	Small left door with assembling kit	1 pc.
P4908835Q	Closing profile with right push-grip, complete with plate for console for trolleys with door	1 pc.

⚠ ACCESSORIES TO BE ORDERED SEPARATELY

00BL1000	Lithium battery	1 pc.
----------	-----------------	-------



MORGAN HOTEL ELEGANCE

ALPHA HOTEL

EMOTION

KEEPHOTEL

TROLLEYS FOR LAUNDRY
COLLECTION

SILVER

EMOTION DRIVE 0305020PE - plastic trolley

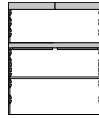

REF.	PCK	VOLUME (m³)	GROSS WEIGHT (kg)	SIZE (cm)
SE0305020PE00	1	1,71	80,3	154x64x149,5

Advised for 10-12 room service - Maximum pull-out shelf capacity 30 kg

0000SM00165	Set of T-shaped light grey closing plugs for vertical frames (6 pcs)	2 pcs
P066481Q	Long base with 2 rubber wheels ø 200x50 mm and 2 bumpers complete with motor kit	1 pc.
P130001Q	Door stopper made of plastic and rubber	1 pc.
P1908839E	Side-walls blocking device	1 pc.
P1918802E	Big fixed side wall	2 pcs
P1948802E	Small fixed side wall	2 pcs
P2038805E	Big vertical frame, 1 side for T-plugs + 1 side with slides, complete with screws	2 pcs
P2038806E	Small vertical frame, 1 smooth side + 1 side with slides	2 pcs
P2228800Q	Long smooth fixed shelf	1 pc.
P2229911Q	Long pull-out shelf	1 pc.
P2908822Q	Right closing profile for Emotion trolleys with door	1 pc.
P2908823Q	Left closing profile for Emotion trolleys with door	1 pc.
P3228800QU	Long smooth fixed shelf with central tray support	1 pc.
P3229915U	Grey pull-out plastic tray with slide out limiter and removable locking key	2 pcs
P375000Q	Supporting plate with bumpers for Emotion	1 pc.
P3928802E	Big right door with lock and assembling kit	1 pc.
P3938802E	Big left door with assembling kit	1 pc.
P3958802E	Small right door with lock and assembling kit	1 pc.
P3968802E	Small left door with assembling kit	1 pc.
P4908835Q	Closing profile with right push-grip, complete with plate for console for trolleys with door	1 pc.
P8268801Q	Left foldable bag holder 120 L with bumpers for Emotion trolleys with door	1 pc.

⚠ ACCESSORIES TO BE ORDERED SEPARATELY

0000AT0120E	Plastic coated bag 120L with grip, grey	1 pc.
00BL1000	Lithium battery	1 pc.



MORGAN HOTEL ELEGANCE

ALPHA HOTEL

EMOTION

KEEPHOTEL

TROLLEYS FOR LAUNDRY
COLLECTION

SILVER

Components for Emotion trolleys

Short base with 5 wheels without bumpers



REF.	NOTES
P159061Q	with wheels ø 125 mm
P159081Q	with 125mm ø castors, 2 lockable

Short base with 5 wheels and bumpers ø 200 mm



REF.	NOTES
P159131Q	with rubber wheels ø 125 mm
P159141Q	with rubber wheels ø 125 mm, 2 with brake
P159261Q	with wheels ø 125 mm with tread 35 mm

Long base with 5 wheels without bumpers



REF.	NOTES
P166061Q	with wheels ø 125 mm
P166081Q	with wheels ø 125 mm, 2 with brake

Long base with 5 wheels and bumpers ø 200 mm



REF.	NOTES
P166131Q	with rubber wheels ø 125 mm
P166141Q	with rubber wheels ø 125 mm, 2 with brake
P166261Q	with wheels ø 125 mm with tread 35 mm

Long base with 4 wheels without bumpers



REF.	NOTES
P066251Q	with rubber wheels ø 150 mm (2 fixed + 2 pirouetting)
P066231Q	with rubber wheels ø 200 mm (2 fixed + 2 pirouetting)
P066281Q	with wheels ø 200 mm (2 fixed + 2 pirouetting)

Supporting plastic plate with 2 wheels

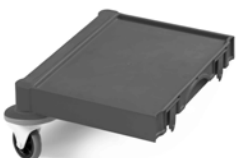

REF.	NOTES
P515060Q	with wheels ø 125 mm without bumpers
P515130Q	with rubber wheels ø 125 mm and bumpers ø 200 mm



MORGAN HOTEL ELEGANCE

ALPHA HOTEL

EMOTION

KEEPHOTEL

TROLLEYS FOR LAUNDRY
COLLECTION

SILVER

Supporting plastic plate with 1 wheel



REF.	NOTES
P075130Q	with rubber wheel ø 125 mm
P075060Q	with wheel ø 125 mm

Base extension for Emotion trolleys

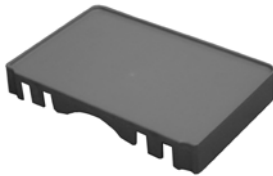

REF.	NOTES	SIZE (cm)
P175000Q		↓ ↓ ↓ 48x32x7

Supporting plate fitting the base of Emotion trolleys



REF.	NOTES	SIZE (cm)
P165000Q		↓ ↓ ↓ 48x22x15

Big vertical frame, 1 side for T-plugs + 1 side with slides, complete with screws



REF.	NOTES
P2038805E	

Big vertical frame, 2 sides with slides, complete with screws



REF.	NOTES
P3038804E	

Small vertical frame, 1 smooth side + 1 side with slides

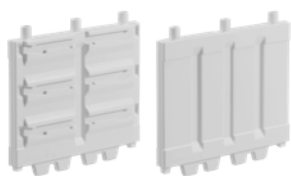

REF.	NOTES
P2038806E	



MORGAN HOTEL ELEGANCE

ALPHA HOTEL

EMOTION

KEEPHOTEL

TROLLEYS FOR LAUNDRY
COLLECTION

SILVER

Small vertical frame, 2 sides with slides

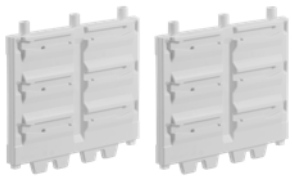

REF.	NOTES
P2038807E	

Small vertical frame, 1 side with slides + 1 side for T-plugs

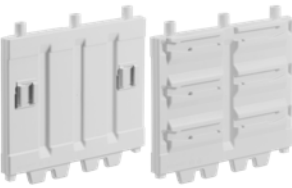

REF.	NOTES
P2038808E	

Set of T-shaped closing plugs for vertical frames (6 pcs)



REF.	NOTES
0000SM00163	dark grey
0000SM00165	light grey

Small fixed side wall



REF.	NOTES
P1948802E	

Big fixed side wall



REF.	NOTES
P1918802E	

Side-walls blocking device



REF.	NOTES
P1908839E	



MORGAN HOTEL ELEGANCE

ALPHA HOTEL

EMOTION

KEEPHOTEL

TROLLEYS FOR LAUNDRY
COLLECTION

SILVER

Big right door with lock and assembling kit



REF.

NOTES

P3928802E

Big left door with assembling kit



REF.

NOTES

P3938802E

Small right door with lock and assembling kit



REF.

NOTES

P3958802E

Small left door with assembling kit



REF.

NOTES

P3968802E

Long smooth fixed shelf



REF.

NOTES

P2228800Q

Long smooth fixed shelf with central tray support



REF.

NOTES

P3228800QU



MORGAN HOTEL ELEGANCE

ALPHA HOTEL

EMOTION

KEEPHOTEL

TROLLEYS FOR LAUNDRY
COLLECTION

SILVER

Big fixed shelf with seat for vertical frame



REF.	NOTES
P2328801Q	

Long fixed shelf with seat for vertical frame and central tray support



REF.	NOTES
P3228801QU	

Small fixed shelf (female-female version)



REF.	NOTES
P1228802Q	

Small fixed shelf (male-female version)



REF.	NOTES
P2228803Q	

Closing profile



REF.	NOTES
P2908820Q	right for Emotion trolley without door
P2908821Q	left for Emotion trolleys without door
P2908822Q	right for Emotion trolleys with door
P2908823Q	left for Emotion trolleys with door

Closing profile with push-grip



REF.	NOTES
P3908833Q	right for Emotion trolley without door
P3908834Q	left for Emotion trolleys without door
P3908835Q	right for Emotion trolleys with door
P3908836Q	left for Emotion trolleys with door

Foldable bag holder 120 L with bumpers



REF.	NOTES
P8268802Q	right for Emotion trolley without door
P8268803Q	left for Emotion trolleys without door
P8268800Q	right for Emotion trolleys with door
P8268801Q	left for Emotion trolleys with door



MORGAN HOTEL ELEGANCE

ALPHA HOTEL

EMOTION

KEEPHOTEL

TROLLEYS FOR LAUNDRY
COLLECTION

SILVER

Foldable bag holder 120 L without bumpers



REF.	NOTES
P8168802Q	right for Emotion trolley without door
P8168803Q	left for Emotion trolleys without door
P8168800Q	right for Emotion trolleys with door
P8168801Q	left for Emotion trolleys with door

Bumper set for 120-litre bag holder (no. 1 right bumper + no. 1 left bumper)



REF.	NOTES
0000SM00260	

Small pull-out shelf

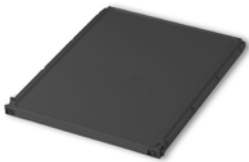

REF.	NOTES	SIZE (cm)
P2229910Q		↓ ↓ ↓ 37,5x46,5

Long pull-out shelf

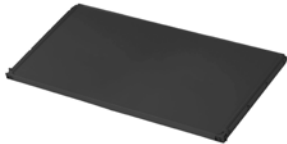

REF.	NOTES	SIZE (cm)
P2229911Q		↓ ↓ ↓ 79x46,5

Plastic sliding tray with slide out limiter and key



REF.	NOTES
P3229915U	

Plastic sliding drawer without locking key



REF.	NOTES	CAPACITY (L)	SIZE (cm)
P1229909U	internal dimensions 41x34x9,5 cm	10	↓ ↓ ↓ 46,5x37,5x11
P1229906U	internal dimensions 40,5x34x16 cm	22	46,5x37,5x17
P1229907U	internal dimensions 40x34x33,5 cm	40	46,5x37,5x35



MORGAN HOTEL ELEGANCE

ALPHA HOTEL

EMOTION

KEEPHOTEL

TROLLEYS FOR LAUNDRY
COLLECTION

SILVER

Plastic sliding drawer with locking key



REF.	NOTES		CAPACITY (L)	SIZE (cm) ↓ ↓ ↓
P2229909U	internal dimensions 41x34x9,5 cm		10	46,5x37,5x11
P2229906A	internal dimensions 40,5x34x16 cm		22	46,5x37,5x17
P2229906B	internal dimensions 40,5x34x16 cm		22	46,5x37,5x17
P2229906U	internal dimensions 40,5x34x16 cm		22	46,5x37,5x17
P2229907U	internal dimensions 40x34x33,5 cm		40	46,5x37,5x35



Rilsan coated support for upright vacuum cleaner fitting vertical frames



REF.	NOTES
R2180085	

Bathrobe and/or towel holder kit



REF.	NOTES
Q1400123E	

Recommended with bag supporting plastic plate

Accessories for Emotion trolleys

Divider for plastic bag holder 120 L



REF.	NOTES
P206020U	2x60 L
P206030U	1x40 L + 1x80 L
P206040U	3x40 L





MORGAN HOTEL ELEGANCE

ALPHA HOTEL

EMOTION

KEEPHOTEL

TROLLEYS FOR LAUNDRY
COLLECTION

SILVER

Plastic divider with square shaped insert for bag holder 120 L



REF.	NOTES
P306020U	2x60 L and 20 L square shaped insert
P406020U	2x60 L and two 20 L square shaped inserts

For Alpha, Emotion range bag holders and bag holder code P906010U, Morgan range

Square plastic support 20 L for the divider of bag holder 120 L

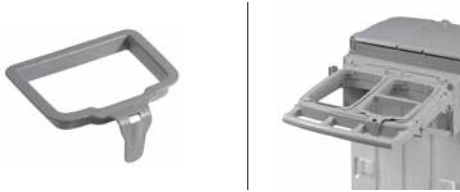

REF.	NOTES
P1909957U	

For Alpha, Emotion range bag holders and bag holder code P906010U, Morgan range - Use recommended with net bags, code 0000AT0210

Plastic cover for bag holder 120 L with check-list holder



REF.	NOTES
P291919A	
P291919B	
P291919T	



Please, require also no. 2 shock absorbing pistons art. P190908U for a perfect soft closing

Plastic cover for bag holder 120 L with storage room, check-list holder and lock

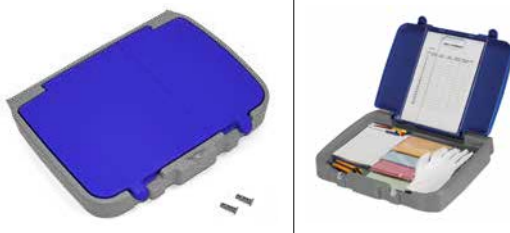

REF.	NOTES
P291920UA	
P291920UB	
P291920U	



Please, require also no. 2 shock absorbing pistons art. P190908U for a perfect soft closing

Tablet holder for mounting on Emotion vertical frame



REF.	NOTES
0000SM00402	

For tablet sizes 7 to 10.1 inches (20 to 31 cm)

Housekeeping trolleys



MORGAN HOTEL ELEGANCE

ALPHA HOTEL

EMOTION

KEEPHOTEL

TROLLEYS FOR LAUNDRY
COLLECTION

SILVER

Plastified bag with bottom grip



REF.	NOTES	CAPACITY (L)	SIZE (cm) ↓ ↓ ↓
0000AT0120E		120	28x42x98

Plastic pocket bags to attach to the vertical frames



REF.	NOTES
Q0400073Q	

Plastic divider for drawer 10 L



REF.	NOTES
0000SM00227D	9 compartments
0000SM00228D	12 compartments

Set of 1 big divider 39 cm + 1 medium divider 32 cm for plastic sliding drawer 22 L

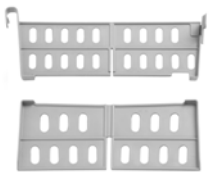

REF.	NOTES
0000SM00213U	

Set of 1 big divider 39 cm + 3 small dividers 16 cm for plastic sliding drawer 22 L

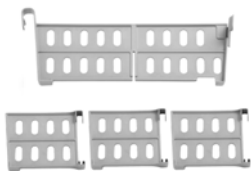

REF.	NOTES
0000SM00214U	

Laundry collection trolley with bag 200 L with zip and closure



REF.	NOTES	PCK	VOLUME (m³)	GROSS WEIGHT (kg)	SIZE (cm) ↓ ↓ ↓
0000HP3110Q5		1	0,244	13,76	101,5x64,5x92



MORGAN HOTEL ELEGANCE

ALPHA HOTEL

EMOTION

KEEPHOTEL

TROLLEYS FOR LAUNDRY
COLLECTION

SILVER

Rilsan coated coupling device to connect the Emotion trolley to a laundry trolley



REF.	NOTES
R1180080	

Side plastic basket



REF.	NOTES
P1191100U	internal sizes 22x49x11,5 cm

Grey waste collection bin 10 L with handle



REF.	NOTES	CAPACITY (L)	SIZE (cm) ↓ ↓ ↓
8168/1U		10	13,5x21x36

UNILAV SIDE GRIP - flat mop with 650ml bottle and holder with strap tapes



REF.	NOTES
0000TD0151A	with plate 40 cm
0000TD0151U	with plate 40 cm
0000TD0161A	with plate 60 cm

Lithium battery for Drive trolleys



REF.	NOTES
00BL1000	



KeepHotel: the trolley for hotels

KeepHotel is a service trolley designed to make cleaning and preparing rooms in hotels, bed & breakfasts and holiday resorts **easier, faster and more discreet**.

Functional and refined with attention paid to the smallest of details, KeepHotel is the **ideal solution for managing accommodations facilities**.

- Thanks to the **plain and essential style** it can be perfectly integrated into the environment in which it is used.
- Its **compact size** allows the ease of movement and access.
- It is designed to offer **maximum practicality** in facilitating various cleaning and tidying operations.
- Spacious and equipped with **useful compartments and movable dividers** to better organize all the equipment.
- Hygienic thanks to the **internal lining that can be easily removed** to facilitate cleaning.



KeepHotel trolleys

KEEPHOTEL - trolley made of plastic coated material with wheels \varnothing 90 mm



REF.	NOTES	PCK	VOLUME (m ³)	GROSS WEIGHT (kg)	SIZE (cm) ↓ ↓ ↓
9590		1	0,192	8,29	67x43x100



Suggested for 2 to 3 rooms

KEEPHOTEL - trolley made of plastic coated material with axial wheels \varnothing 200 mm



REF.	NOTES	PCK	VOLUME (m ³)	GROSS WEIGHT (kg)	SIZE (cm) ↓ ↓ ↓
9591		1	0,203	10,32	67x48x108



Suggested for 2 to 3 rooms



MORGAN HOTEL ELEGANCE

ALPHA HOTEL

EMOTION

KEEPHOTEL

TROLLEYS FOR LAUNDRY
COLLECTION

SILVER

KEEPHOTEL - trolley made of plastic coated material with Rilsan coated frame and wheels \varnothing 300 mm



REF.	NOTES	PCK	VOLUME (m ³)	GROSS WEIGHT (kg)	SIZE (cm) ↓ ↓ ↓
9592		1	0,314	14,25	77x50x114



Suggested for 2 to 3 rooms

KEEPHOTEL - trolley made of plastic coated material with Rilsan coated frame and 4 wheels \varnothing 80 mm, 2 with brake



REF.	NOTES	PCK	VOLUME (m ³)	GROSS WEIGHT (kg)	SIZE (cm) ↓ ↓ ↓
9593		1	0,314	12,08	67x43x97,5



Suggested for 2 to 3 rooms



MORGAN HOTEL ELEGANCE

ALPHA HOTEL

EMOTION

KEEPHOTEL

TROLLEYS FOR LAUNDRY COLLECTION

SILVER

"X" trolley for laundry collection

Thanks to the **foldable X-trolley** it is easier to handle the linen management in the accomodation facilities, assuring the **maximum confort and practicality**:

- The plastic coated bag is equipped with zip to empty the content easily
- The metal structure assures the maximum shock-proof resistance
- The pivoting wheels help to handle the trolley
- Foldable to reduce the overall dimensions, suitable also for the smallest closets
- Available with bag 200L or two bags 100L for the laundry separate collection



"X" trolley for laundry collection

Foldable laundry trolley with plastic coated bag and pirouetting wheels Ø 80 mm



REF.	NOTES	PCK	VOLUME (m³)	GROSS WEIGHT (kg)	SIZE (cm) ↓ ↓ ↓
3105	with bag 200L	1	0,16	9,24	88,5x54x97
3106	with 2 bags 100L	1	0,16	10	88,5x54x97

Folded trolley dimensions cm 88,5x20x108 h

Chromed X-trolley for laundry collection, plastified bag and pirouetting wheels ø 80 mm



REF.	NOTES	PCK	VOLUME (m³)	GROSS WEIGHT (kg)	SIZE (cm) ↓ ↓ ↓
8043	with 4 hooks and bag 150 L	5	0,302	34,68	62x60x103
8044	with 6 hooks and bag 180 L	2	0,21	18,79	62x70x103



Trolleys for laundry collection with pedal and cover

70 lt Rilsan coated trolley for laundry collection with push-bar, pedal, cover, pistons, elastic and ø 80 mm pirouetting wheels



REF.	NOTES	PCK	VOLUME (m³)	GROSS WEIGHT (kg)	SIZE (cm)
R9276		1	0,22	8,27	48,2x48x97



70 lt Rilsan coated trolley for laundry collection with pedal, cover, pistons, elastic and ø 80 mm pirouetting wheels



REF.	NOTES	PCK	VOLUME (m³)	GROSS WEIGHT (kg)	SIZE (cm)
R9176		1	0,215	7,21	48,2x39,2x95



2x70 lt Rilsan trolley for laundry collection with push-bar, pedal, covers, pistons, elastics and ø 80 mm pirouetting wheels



REF.	NOTES	PCK	VOLUME (m³)	GROSS WEIGHT (kg)	SIZE (cm)
R9277		1	0,27	14,42	48,2x89x97



2x70 lt Rilsan trolley for laundry collection with pedals, covers, pistons, elastics and ø 80 mm pirouetting wheels



REF.	NOTES	PCK	VOLUME (m³)	GROSS WEIGHT (kg)	SIZE (cm)
R9177		1	0,215	11,71	48,2x74,5x95



TROLLEYS COMPLETE WITH SHOCK ABSORBING PISTONS FOR A SILENT AND SOFT CLOSURE OF THE COVER



MORGAN HOTEL ELEGANCE

ALPHA HOTEL

EMOTION

KEEPHOTEL

TROLLEYS FOR LAUNDRY COLLECTION

SILVER

3x70 lt Rilsan trolley for laundry collection with pedals, covers, pistons, elastics and ø 80 mm pirouetting wheels



REF.	NOTES	PCK	VOLUME (m³)	GROSS WEIGHT (kg)	SIZE (cm) ↓ ↓ ↓
R9178		1	0,27	16,97	48,2x110x95



4x70 lt Rilsan trolley for laundry collection with pedals, covers, pistons, elastics and ø 80 mm pirouetting wheels



REF.	NOTES	PCK	VOLUME (m³)	GROSS WEIGHT (kg)	SIZE (cm) ↓ ↓ ↓
R9179		1	0,31	21,49	48,2x146x95



Trolleys for laundry collection with cover

70 lt Rilsan coated trolley for laundry collection with push-bar, cover, pistons, elastic and ø 80 mm pirouetting wheels



REF.	NOTES	PCK	VOLUME (m³)	GROSS WEIGHT (kg)	SIZE (cm) ↓ ↓ ↓
R9266		1	0,22	7,76	48,2x48x97



70 lt Rilsan coated trolley for laundry collection with cover, pistons, elastic and ø 80 mm pirouetting wheels



REF.	NOTES	PCK	VOLUME (m³)	GROSS WEIGHT (kg)	SIZE (cm) ↓ ↓ ↓
R9166		1	0,215	6,8	48,2x39,2x95



TROLLEYS COMPLETE WITH SHOCK ABSORBING PISTONS FOR A SILENT AND SOFT CLOSURE OF THE COVER



MORGAN HOTEL ELEGANCE

ALPHA HOTEL

EMOTION

KEEPHOTEL

TROLLEYS FOR LAUNDRY COLLECTION

SILVER

2x70 lt Rilsan trolley for laundry collection with push-bar, covers, pistons, elastics and ø 80 mm pirouetting wheels



REF.	NOTES	PCK	VOLUME (m³)	GROSS WEIGHT (kg)	SIZE (cm) ↓ ↓ ↓
R9267		1	0,27	13,69	48,2x89x97



2x70 lt Rilsan trolley for laundry collection with covers, pistons, elastics and ø 80 mm pirouetting wheels



REF.	NOTES	PCK	VOLUME (m³)	GROSS WEIGHT (kg)	SIZE (cm) ↓ ↓ ↓
R9167		1	0,215	10,89	48,2x74,5x95



3x70 lt Rilsan trolley for laundry collection with covers, pistons, elastics and ø 80 mm pirouetting wheels



REF.	NOTES	PCK	VOLUME (m³)	GROSS WEIGHT (kg)	SIZE (cm) ↓ ↓ ↓
R9168		1	0,27	15,74	48,2x110x95



4x70 lt Rilsan trolley for laundry collection with covers, pistons, elastics and ø 80 mm pirouetting wheels



REF.	NOTES	PCK	VOLUME (m³)	GROSS WEIGHT (kg)	SIZE (cm) ↓ ↓ ↓
R9169		1	0,31	19,85	48,2x146x95





Trolleys for laundry collection without cover and pedal

Rilsan coated trolley for laundry collection 70 L with push-grip, elastic and pirouetting wheels ø 80 mm



REF.	NOTES	PCK	VOLUME (m³)	GROSS WEIGHT (kg)	SIZE (cm) ↓ ↓ ↓
R9256		1	0,22	7	48,2x48x97



Rilsan coated trolley for laundry collection 70 L complete with elastic and pirouetting wheels ø 80 mm



REF.	NOTES	PCK	VOLUME (m³)	GROSS WEIGHT (kg)	SIZE (cm) ↓ ↓ ↓
R9156		1	0,215	6,3	48,2x39,2x95

Rilsan coated trolley for laundry collection 70 L with push-grip, elastics and pirouetting wheels ø 80 mm



REF.	NOTES	PCK	VOLUME (m³)	GROSS WEIGHT (kg)	SIZE (cm) ↓ ↓ ↓
R9257		1	0,27	12,47	48,2x89x97



Rilsan coated trolley for laundry collection 2x70 L complete with elastics and pirouetting wheels ø 80 mm



REF.	NOTES	PCK	VOLUME (m³)	GROSS WEIGHT (kg)	SIZE (cm) ↓ ↓ ↓
R9157		1	0,215	9,89	48,2x74,5x95

Rilsan coated trolley for laundry collection 3x70 L complete with elastics and pirouetting wheels ø 80 mm



REF.	NOTES	PCK	VOLUME (m³)	GROSS WEIGHT (kg)	SIZE (cm) ↓ ↓ ↓
R9158		1	0,27	14,24	48,2x110x95



MORGAN HOTEL ELEGANCE

ALPHA HOTEL

EMOTION

KEEPHOTEL

TROLLEYS FOR LAUNDRY COLLECTION

SILVER

Rilsan coated trolley for laundry collection 4x70 L complete with elastics and pirouetting wheels ø 80 mm



REF.	NOTES	PCK	VOLUME (m³)	GROSS WEIGHT (kg)	SIZE (cm) ↓ ↓ ↓
R9159		1	0,31	17,85	48,2x146x95

Components for trolleys for laundry collection

Plastified bag with front opening for foldable X-trolley for laundry collection



REF.	NOTES	CAPACITY (L)
Q0400131E		200
Q0400132E		100

Kit wheels and bumpers for laundry collection trolleys art. 3105-3106



REF.	NOTES
0000SM00312	

Supporting plastic plate for laundry trolleys art. R9176, R9177, R9178 and R9179

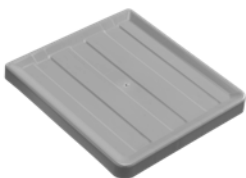

REF.	NOTES
P114021U	

Plastic pedal for laundry trolleys art. R9176, R9177, R9178 and R9179



REF.	NOTES
P190928U	

Housekeeping trolleys



MORGAN HOTEL ELEGANCE

ALPHA HOTEL

EMOTION

KEEPHOTEL

**TROLLEYS FOR LAUNDRY
COLLECTION**

SILVER

Stainless steel back rod connecting pedal/cover Ø 5,8 mm, length 76 cm for laundry trolleys art. R9176, R9177, R9178 e R9179



REF.	NOTES
I1900011	

Plastic plug to fix back rod connecting pedal/cover for laundry trolleys art. R9176, R9177, R9178 and R9179



REF.	NOTES
P190927U	

Double fixing device with snap closure for laundry trolleys art. R9176, R9177, R9178 and R9179



REF.	NOTES
8229U	

Plastic cover for laundry trolleys art. R9176, R9177, R9178 and R9179



REF.	NOTES
P290929A	
P290929B	
P290929C	
P290929F	

Bag fixing elastic



REF.	NOTES
8054	for trolleys art.8045,8070,8075,8076,8077,8077/1,R8377,8040 and 8440
8054/1	for Trend and laundry trolleys

Pistons kit for soft-close lid on laundry trolleys



REF.	NOTES
0000SM00640	



HOUSEKEEPING
TROLLEYS



MORGAN HOTEL ELEGANCE

ALPHA HOTEL

EMOTION

KEEPHOTEL

TROLLEYS FOR LAUNDRY COLLECTION

SILVER



Silver trolleys are practical and handy service trolleys, ideal for hotels, restaurants, company canteens and fast-food chains.

Silver is also available in the **panelled version**:

- **Higher capacity and safer:** thanks to the plastic closing walls storage possibilities and stability during transportation are surely improved, thus offering an even more efficient service
- **Smarter and more versatile:** its neat and modern design with two colour options makes it suitable for all environments
- **More hygienic and ergonomic:** thanks to its smooth surfaces with rounded up corners it can be easily cleaned and thanks to its ergonomic push-bars it can be easily handled
- **Stronger:** Silver is handy and very strong as it is manufactured with aluminium vertical frames and plastic shelves/walls (up to 50 kg per each shelf)
- **More silent:** it is available also with rubber wheels \varnothing 125 mm, highly sliding and silent, with bumpers



Versions closed by plastic panels, available in two colours



Available also with rubber wheels \varnothing 125 mm and with shock-absorbing bumpers



Ergonomic, rounded shape and plastic push-bar



Silver trolleys

SILVER 1200 - service trolley with aluminium vertical frames, 2 shelves and wheels \varnothing 100x28 mm

SILVER 1300 - service trolley with aluminium vertical frames, 3 shelves and wheels \varnothing 100x28 mm



REF.	NOTES	PCK	VOLUME (m ³)	GROSS WEIGHT (kg)	SIZE (cm)
0000SP1200D		1	0,127	15,28	111x50x103
0000SP1200E		1	0,127	15,28	111x50x103

Maximum load capacity of each shelf: 50 kg

REF.	NOTES	PCK	VOLUME (m ³)	GROSS WEIGHT (kg)	SIZE (cm)
0000SP1300D		1	0,163	16,76	111x50x103
0000SP1300E		1	0,163	16,76	111x50x103

Max load capacity 50 kg/shelf - Available height between the individual shelves about 32 cm

Housekeeping trolleys



MORGAN HOTEL ELEGANCE

ALPHA HOTEL

EMOTION

KEEPHOTEL

TROLLEYS FOR LAUNDRY
COLLECTION

SILVER

SILVER 1310 - service trolley with plastical vertical frames, 3 shelves and wheels ø 100x28 mm



REF.	NOTES	PCK	VOLUME (m³)	GROSS WEIGHT (kg)	SIZE (cm) ↓ ↓ ↓
0000SP1310D	<input type="checkbox"/>	1	0,163	16,24	111x50x103
0000SP1310E	<input checked="" type="checkbox"/>	1	0,163	16,24	111x50x103

Max load capacity 50 kg/shelf - Available height between the individual shelves about 32 cm

SILVER 1300-16 - trolley with aluminium vertical frames, 3 shelves, rubber wheels ø 125 mm and bumpers ø 130 mm



REF.	NOTES	PCK	VOLUME (m³)	GROSS WEIGHT (kg)	SIZE (cm) ↓ ↓ ↓
0000SP1300D16	<input type="checkbox"/>	1	0,163	17,29	111x58x104
0000SP1300E16	<input checked="" type="checkbox"/>	1	0,163	17,29	111x58x104

Max load capacity 50 kg/shelf - Available height between the individual shelves about 32 cm

SILVER 1301 - service trolley with aluminium vertical frames, 3 shelves and wheels ø 100x28 mm and closing walls



REF.	NOTES	PCK	VOLUME (m³)	GROSS WEIGHT (kg)	SIZE (cm) ↓ ↓ ↓
0000SP1301D	<input type="checkbox"/>	1	0,193	20,75	111x50x103
0000SP1301E	<input checked="" type="checkbox"/>	1	0,193	20,75	111x50x103

Max load capacity 50 kg/shelf - Available height between the individual shelves about 32 cm

SILVER 1301-16 - trolley with aluminium vertical frames, 3 shelves, rubber wheels ø 125 mm, bumpers ø 130 mm and closing walls



REF.	NOTES	PCK	VOLUME (m³)	GROSS WEIGHT (kg)	SIZE (cm) ↓ ↓ ↓
0000SP1301D16	<input type="checkbox"/>	1	0,193	21,48	111x58x107
0000SP1301E16	<input checked="" type="checkbox"/>	1	0,193	21,48	111x58x107

Max load capacity 50 kg/shelf - Available height between the individual shelves about 32 cm



MORGAN HOTEL ELEGANCE

ALPHA HOTEL

EMOTION

KEEPHOTEL

TROLLEYS FOR LAUNDRY
COLLECTION

SILVER

SILVER 2410 - trolley with 4 shelves, plastic vertical frames and plastic feet



SILVER 2510 - trolley with 5 shelves, plastic vertical frames and plastic feet



REF.	NOTES	PCK	VOLUME (m³)	GROSS WEIGHT (kg)	SIZE (cm)
0000SP2410E		1	0,232	18,71	90x50x127

Max load capacity 50 kg/shelf - Available height between shelves approx. 30 cm

REF.	NOTES	PCK	VOLUME (m³)	GROSS WEIGHT (kg)	SIZE (cm)
0000SP2510E		1	0,277	22,21	90x50x163

Max load capacity 50 kg/shelf - Available height between shelves approx. 30 cm

Components for Silver trolleys

Plastic base for Silver trolley



REF.	NOTES	SIZE (cm)
P104001D	for Silver trolley with wheels	89x49
P104001E	for Silver trolley with wheels	89x49

Central plastic shelf for Silver trolley



REF.	NOTES	SIZE (cm)
P104002D	for Silver trolley with wheels	89x49
P104002E		89x49

Top plastic shelf for Silver trolley



REF.	NOTES	SIZE (cm)
P104003D	For Silver trolley with push-bar	89x49
P104003E	For Silver trolley with push-bar	89x49

Kit for closing the lower part of Silver trolleys



REF.	NOTES
0000SM00244D	
0000SM00244E	

Housekeeping trolleys



MORGAN HOTEL ELEGANCE

ALPHA HOTEL

EMOTION

KEEPHOTEL

TROLLEYS FOR LAUNDRY
COLLECTION

SILVER

Kit for closing the upper part of Silver trolleys



REF.	NOTES
0000SM00245D	
0000SM00245E	

Plastic push-bar for Silver trolley



REF.	NOTES
P179080U	

Plastic vertical frame 29,6 cm for Silver trolleys with 3 shelves



REF.	NOTES
PA50028N	

Aluminium vertical frame for Silver trolley



REF.	NOTES	SIZE (cm)
TA50029	for Silver with 3 shelves	↓ ↓ ↓ 29,6
TA50066	for Silver with 2 shelves	66

Accessories for Silver trolleys

Plastic bin 25 L for Silver trolley



REF.	NOTES	PCK	VOLUME (m³)	GROSS WEIGHT (kg)
8269/1		4	0,095	4,76





Accessories for trolleys

Carry baskets

Paper holders for
paper rolls

Quivers

Holder for gloves and
disinfectant solution

Door stoppers

Hoses for bucket filling

Note boards

Hooks

Bags

Wheels

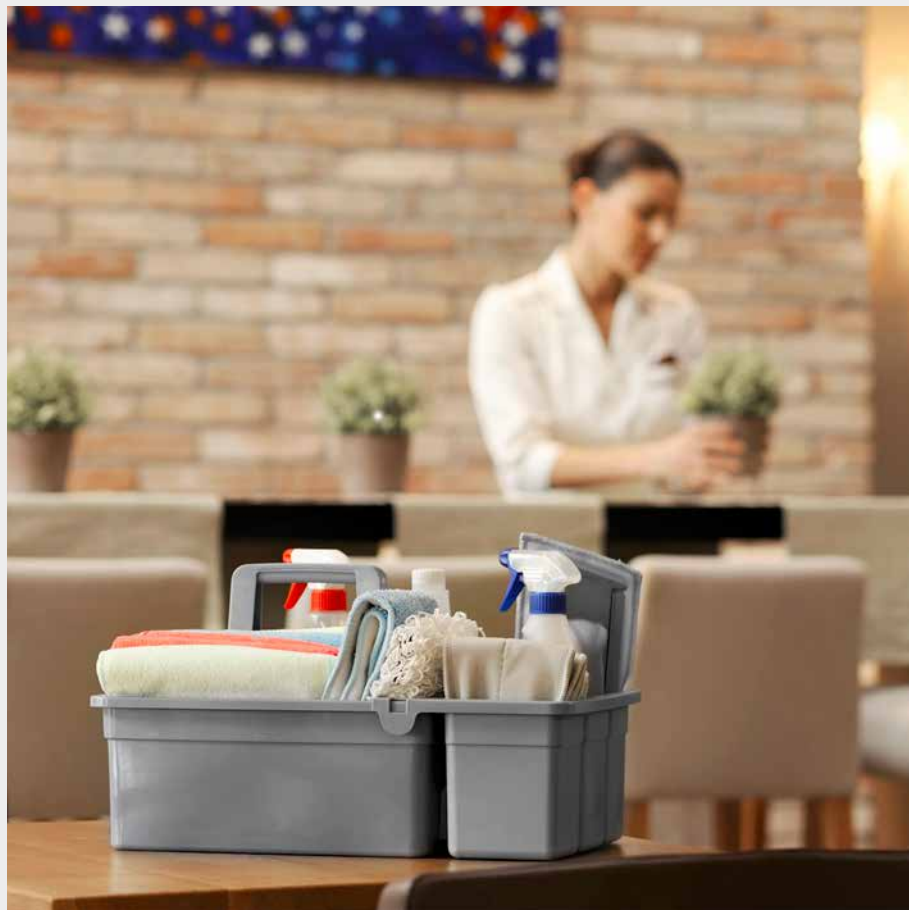



- CARRY BASKETS
- PAPER HOLDERS FOR PAPER ROLLS
- QUIVERS
- HOLDER FOR GLOVES AND DISINFECTANT SOLUTION
- DOOR STOPPERS
- HOSES FOR BUCKET FILLING
- NOTE BOARDS
- HOOKS
- BAGS
- WHEELS

■ Baskets with dividers

Plastic basket complete with 3 dividers



REF.	NOTES
P2191101U	1. suitable for the closing profile and bag holder 120 L of Alpha trolleys
P2191103U	1. for mounting on Alpha trolley finishing trim and 120l bag holder - with long fittings
P2191102U	2. suitable for the vertical frames of Alpha trolleys
P219007U	3. suitable for the vertical frame of Morgan trolley art. 0000MP3080A

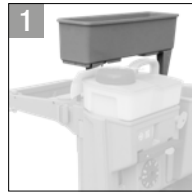

■ Carry baskets with grip

Plastic carry basket with special shaped bottle holder, 2 compartments and fixed grip



REF.	NOTES	SIZE (cm) ↓ ↓ ↓
3690U		33,5x28,3x27



Plastic carry basket with special shaped bottle holder, 2 compartments and grip



REF.	NOTES	SIZE (cm) ↓ ↓ ↓
3691U		32,5x25x31

Plastic carry basket complete with 3 dividers and grip



REF.	NOTES	SIZE (cm) ↓ ↓ ↓
3669U		32,5x25x31

Plastic carry basket with 3 compartments and grip



REF.	NOTES	SIZE (cm) ↓ ↓ ↓
3635U		40x29x17

- CARRY BASKETS
- PAPER HOLDERS FOR PAPER ROLLS
- QUIVERS
- HOLDER FOR GLOVES AND DISINFECTANT SOLUTION
- DOOR STOPPERS
- HOSES FOR BUCKET FILLING
- NOTE BOARDS
- HOOKS
- BAGS
- WHEELS

Accessories for carry baskets

Side plastic basket with 3 compartments fitting basket art. 3690U



REF.	NOTES	SIZE (cm) ↓ ↓ ↓
60405U		17x28,3x14

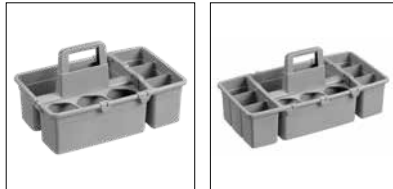

Plastic bottle holder with 3 shaped holes for baskets art. 3691U and 3690U



REF.	NOTES	SIZE (cm) ↓ ↓ ↓
60404U		12,2x32x4

Divider for plastic basket art. 3669U



REF.	NOTES
P1909940U	

Rilsan coated holder for carry basket art. 3690U



REF.	NOTES
R2240040	fitting Morgan Hotel trolleys



Rilsan coated holder for carry basket art. 3635U



REF.	NOTES
R2240030	fitting Morgan Hotel trolleys





- CARRY BASKETS
- PAPER HOLDERS FOR PAPER ROLLS
- QUIVERS
- HOLDER FOR GLOVES AND DISINFECTANT SOLUTION
- DOOR STOPPERS
- HOSES FOR BUCKET FILLING
- NOTE BOARDS
- HOOKS
- BAGS
- WHEELS

Carry baskets with support

Plastic carry basket



REF.	NOTES	SIZE (cm) ↓ ↓ ↓
60402A		32x13x14

Plastic support for basket

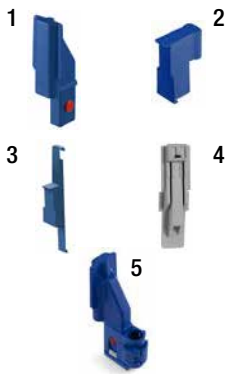

REF.	NOTES
P290800A	1. for Orion-Fred trolleys frame
P179002A	2. for bag holder art. P206002A of Vega trolley
P179001A	3. for Maxi Jolly single bucket
P1901113U	4. for vertical frame of Alpha trolleys
0000SM00126	5. for vertical frames ø 22 mm



Vertical paper holder

Set of vertical paper holder for Morgan trolleys



REF.	NOTES
P225005U	

Paper holder with cover

Set of plastic paper holder with cover complete with 3 hooks



REF.	NOTES
P225004A	

CARRY BASKETS

PAPER HOLDERS FOR PAPER ROLLS

QUIVERS

HOLDER FOR GLOVES AND DISINFECTANT SOLUTION

DOOR STOPPERS

HOSES FOR BUCKET FILLING

NOTE BOARDS

HOOKS

BAGS

WHEELS

Plastic paper holder

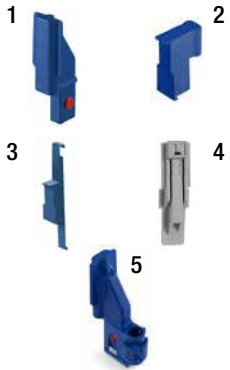

REF.	NOTES
P290800A	1. for Orion-Fred trolleys frame
P179002A	2. for bag holder art. P206002A of Vega trolley
P179001A	3. for Maxi Jolly single bucket
P1901113U	4. for vertical frame of Alpha trolleys
0000SM00126	5. for vertical frames ø 22 mm



Rilsan coated support for paper holder complete with hooks and closing profile, fitting Alpha trolleys



REF.	NOTES
0000SM00643	



Plastic quivers

Plastic quiver for polybags



REF.	NOTES
P120007A	

Plastic quiver for window squeegees, washers, scrapers



REF.	NOTES
P120008A	

Plastic support for quivers

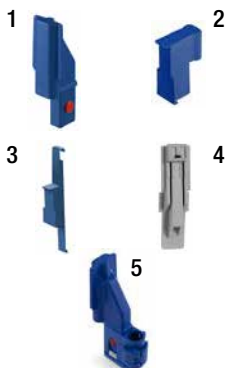

REF.	NOTES
P290800A	1. for Orion-Fred trolleys frame
P179002A	2. for bag holder art. P206002A of Vega trolley
P179001A	3. for Maxi Jolly single bucket
P1901113U	4. for vertical frame of Alpha trolleys
0000SM00126	5. for vertical frames ø 22 mm





CARRY BASKETS

PAPER HOLDERS FOR PAPER ROLLS

QUIVERS

HOLDER FOR GLOVES AND DISINFECTANT SOLUTION

DOOR STOPPERS

HOSES FOR BUCKET FILLING

NOTE BOARDS

HOOKS

BAGS

WHEELS

Steel holder for gloves and disinfectant

Holder for gloves and disinfectant solution



REF.	NOTES	SIZE (cm) ↓ ↓ ↓
I1050073	1. fitting Alpha bag holder 150 L 2. fitting Alpha central ring	10x22x25
I1052073	3. fitting Alpha closing profile thanks to the long holder P1909959U 4. fitting Morgan central baskets	11x22x25



Holder for disinfectant solution with support base



REF.	NOTES	SIZE (cm) ↓ ↓ ↓
I1050074	1. fitting Alpha bag holder 150 L 2. fitting Alpha central ring	11,5x10x9,5
I1051074	3. fitting Alpha closing profile thanks to the long holder P1909959U	13,5x10x9,5
I1052074	4. fitting Alpha central upper baskets 5. fitting Morgan central baskets	12,5x10x9,5



Holder for disinfectant solution without support base



REF.	NOTES	SIZE (cm) ↓ ↓ ↓
I1050075	1. fitting Alpha bag holder 150 L 2. fitting Alpha central ring	9x9x10
I1051075	3. fitting Alpha closing profile thanks to the long holder P1909959U	13,5x9x10
I1052075	4. fitting Alpha central upper baskets 5. fitting Morgan central baskets	11x9x10



Gloves holder



REF.	NOTES	SIZE (cm) ↓ ↓ ↓
I1050076	1. fitting Alpha bag holder 150 L 2. fitting Alpha closing profile thanks to the long holder P1909959U	10x25x14
I1051076	3. fitting Alpha central upper baskets	12x25x14
I1052076	4. fitting Morgan central baskets	11x25x14



CARRY BASKETS

PAPER HOLDERS FOR PAPER ROLLS

QUIVERS

HOLDER FOR GLOVES AND DISINFECTANT SOLUTION

DOOR STOPPERS

HOSES FOR BUCKET FILLING

NOTE BOARDS

HOOKS

BAGS

WHEELS

■ Universal door stoppers

Door stopper made of plastic and rubber

REF.	NOTES	PCK	VOLUME (m³)	GROSS WEIGHT (kg)	SIZE (cm) ↓ ↓ ↓
P130001Q		50	0,028	3,32	15x7,9x5



Door stopper made of plastic and rubber with handle 87 cm

REF.	NOTES	PCK	VOLUME (m³)	GROSS WEIGHT (kg)	SIZE (cm) ↓ ↓ ↓
P230001Q		6	0,014	1,77	15,7x7,9x90



■ Hoses

Hose for bucket filling 110 cm



REF.	NOTES
P190010E	

Hose for bucket filling 150 cm



REF.	NOTES
P190020U	

Universal hose connection fitting all types of taps



CARRY BASKETS

PAPER HOLDERS FOR PAPER ROLLS

QUIVERS

HOLDER FOR GLOVES AND DISINFECTANT SOLUTION

DOOR STOPPERS

HOSES FOR BUCKET FILLING

NOTE BOARDS

HOOKS

BAGS

WHEELS

Boards

Plastic board



REF.	NOTES
P299001C	1. suitable for vertical paper holder art. P225001A
0000PA0101C	2. suitable for tubes \varnothing 22 mm
0000PA0104C	3. suitable for tubes \varnothing 22 mm
0000PA0102C	4. suitable for the profile of Alpha trolleys



Uni-Move: universal handle hook

An universal handle holder for any type of handle!

Uni-Move is the handle holder by Filmop to **hang quickly and easily any type of handle** to the service trolley.

Thanks to its **special flexible structure**, Uni-Move **can be fixed in few seconds** to any tool, regardless of its shape or size.



UNIVERSAL

Thanks to its original and innovating design with a flexible rubber part, it is compatible with handles of several diameters (from 21 mm to 29 mm).



TWO MATERIALS COMBINED TOGETHER AND RESISTANT

Made of plastic and extensible, shock-absorbing and non-slip rubber, all in one mould.



FAST

It can be fixed and removed in just a few seconds.



Uni-Move handle holder

UNI-MOVE - universal plastic handle holder



REF.

NOTES

0000SM00250U

Plastic support for Uni-Move hook with sign holder



REF.

NOTES

P1919969U

short - fitting the central frame with cover of Alpha trolleys

P1929969U

long - fitting the bag holder 150 L and profile of Alpha trolleys

Holder for Uni-Move handle holder

REF.

NOTES

P1909901U



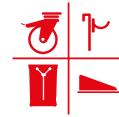

CARRY BASKETS

PAPER HOLDERS FOR PAPER ROLLS

QUIVERS

HOLDER FOR GLOVES AND DISINFECTANT SOLUTION

DOOR STOPPERS

HOSES FOR BUCKET FILLING

NOTE BOARDS

HOOKS

BAGS

WHEELS

Handle holders

Plastic handle holder



REF.	NOTES
0000SM00100U	1. for basket art. 60402A and bucket holder art. P220001E for Vega-Arka trolleys
0000SM00129U	2. fitting push-bar art. 7964A-7966A for Orion-Vega-Arka trolleys
60072U	3. for Delta bag holder - Alpha bag holder and closing profile
0000SM00122U	4. for Alpha and Morgan side basket
0000SM00206U	5. for Alpha central basket
8214U	6. turning, with screws for tubes \varnothing 22 mm
8223U	6. turning, with screws for tubes \varnothing 14 mm (art. 7151 - 7166)
0000SM00098U	6. turning, with screws for tubes \varnothing 18 mm
0000SM00112U	7. turning, with snap closure for tubes \varnothing 22 mm

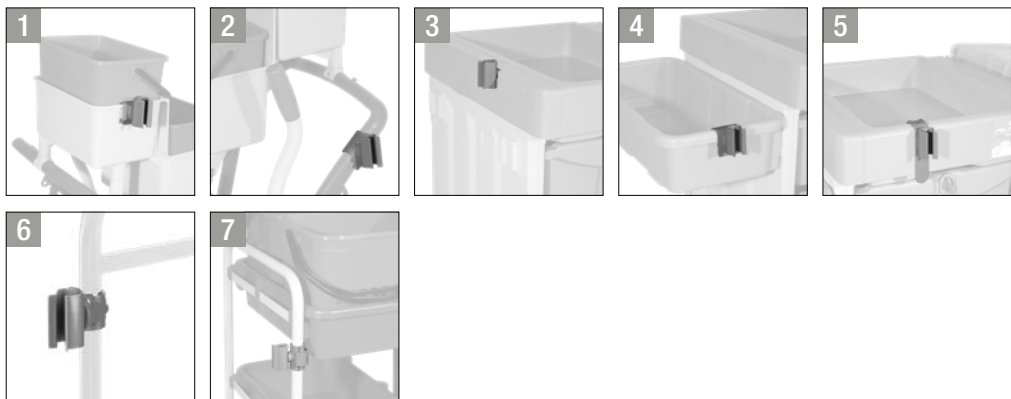

Hooks

Plastic hook



REF.	NOTES
0000SM00215U	1. for basket art. 60402A and bucket holder art. P220001E for Vega-Arka trolleys
0000SM00102U	2. fitting push-bar art. 7964A-7966A for Orion-Vega-Arka trolleys
60082U	3. for Delta bag holder - Alpha bag holder and closing profile
0000SM00205U	4. for Alpha and Morgan side basket
0000SM00212U	5. for Alpha central basket
0000SM00097U	6. turning, with screws for tubes \varnothing 18 mm
8235	6. turning, with screws for tubes \varnothing 14 mm (art. 7151 - 7166)
0000SM00113U	7. turning, with snap closure for tubes \varnothing 22 mm

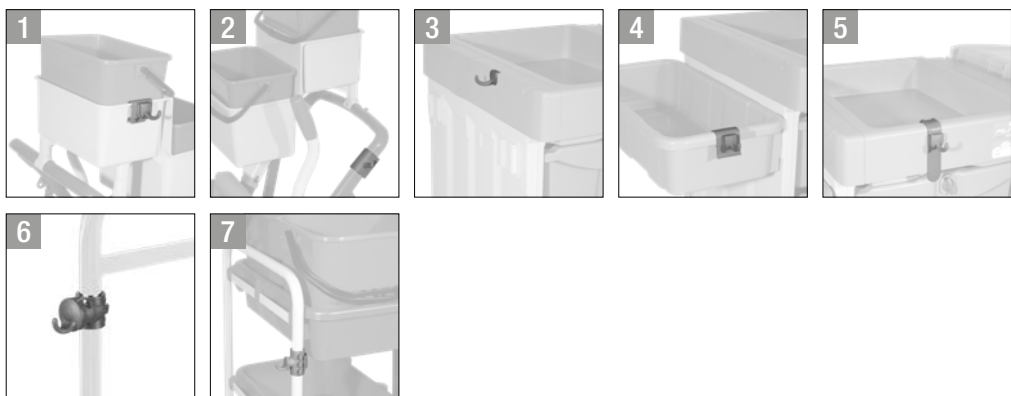

CARRY BASKETS

PAPER HOLDERS FOR PAPER ROLLS

QUIVERS

HOLDER FOR GLOVES AND DISINFECTANT SOLUTION

DOOR STOPPERS

HOSES FOR BUCKET FILLING

NOTE BOARDS

HOOKS

BAGS

WHEELS

Bis hooks

BIS - double plastic hook

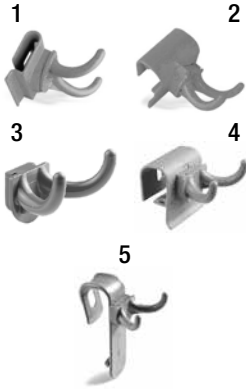

REF.	NOTES
0000SM00140U	1. for basket art. 60402A and bucket holder art. P220001E for Vega-Arka trolleys
0000SM00139U	2. fitting push-bar art. 7964A-7966A for Orion-Vega-Arka trolleys
60080U	3. for Delta bag holder - Alpha bag holder and closing profile
0000SM00141U	4. for Alpha and Morgan side basket
0000SM00208U	5. for Alpha central basket



Flip handle holders

FLIP - handle holder with rubber roll

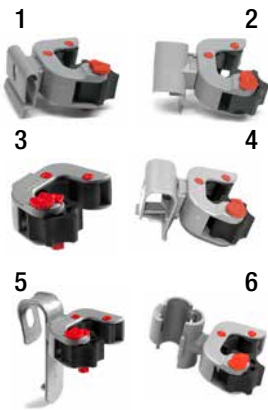

REF.	NOTES
0000SM00110U	1. for basket art. 60402A and bucket holder art. P220001E for Vega-Arka trolleys
0000SM00130U	2. fitting push-bar art. 7964A-7966A for Orion-Vega-Arka trolleys
0000SM00155U	3. for Delta bag holder - Alpha bag holder and closing profile
0000SM00121U	4. for Alpha and Morgan side basket
0000SM00209U	5. for Alpha central basket
0000SM00115U	6. with snap closure for tubes \varnothing 22 mm

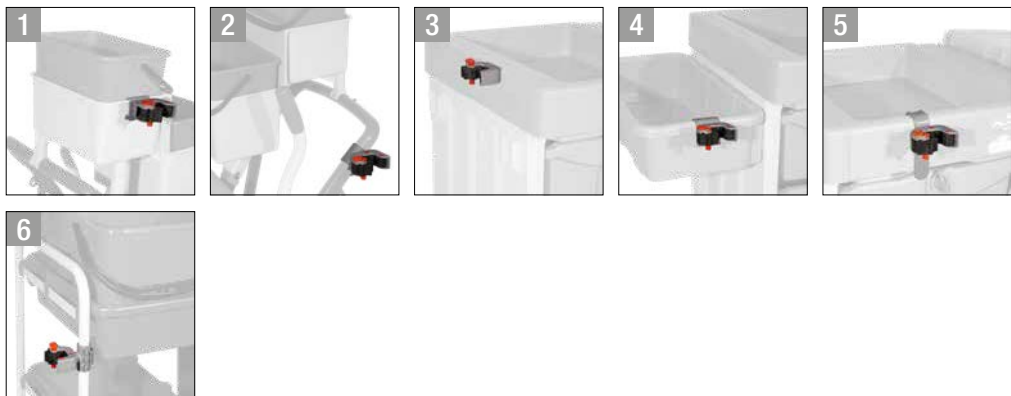



CARRY BASKETS

PAPER HOLDERS FOR PAPER ROLLS

QUIVERS

HOLDER FOR GLOVES AND DISINFECTANT SOLUTION

DOOR STOPPERS

HOSES FOR BUCKET FILLING

NOTE BOARDS

HOOKS

BAGS

WHEELS

■ Holders for spray bottles

Plastic holder for spray bottles

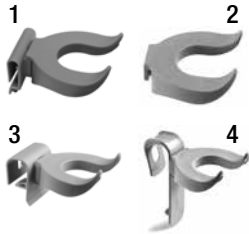

REF.	NOTES
0000SM00145U	1. for basket art. 60402A and bucket holder art. P220001E for Vega-Arka trolleys
P190208U	2. for Delta bag holder, Alpha bag holder and closing profile
0000SM00146U	3. for Alpha and Morgan side basket
0000SM00210U	4. for Alpha central basket

1

2

3

4

■ Holders for plastic hoses

Plastic holder for hose ø 32 mm

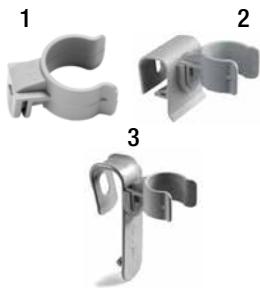

REF.	NOTES
P190209U	1. for Delta bag holder, Alpha bag holder and closing profile
0000SM00149U	2. for Alpha and Morgan side basket
0000SM00211U	3. for Alpha central basket

1

2

3

■ Plastified bags

Plastified bag with string



REF.	NOTES	CAPACITY (L)	SIZE (cm)
0000AT0310A	for Alpha with Split system	45	32x23x63
0000AT0310B	for Alpha with Split system	45	32x23x63
0000AT0170A	for divider 1x40 L + 1x80 L	60	48x97
0000AT0170B	for divider 1x40 L + 1x80 L	60	48x97
0000AT0170E	for divider 1x40 L + 1x80 L	60	48x97
0000AT0160A	for divider 1x40 L + 1x80 L	80	56x92
0000AT0160B	for divider 1x40 L + 1x80 L	80	56x92
0000AT0160E	for divider 1x40 L + 1x80 L	80	56x92
0000AT0300A	for Alpha with Split system	90	50x28x63
0000AT0300B	for Alpha with Split system	90	50x28x63
0000AT0200A	for divider 100 L + 50 L	100	65x93
0000AT0200B	for divider 100 L + 50 L	100	65x93
3650A		120	73x97
3650B		120	73x97
0000AT0190A		150	79x96
0000AT0190B		150	79x96
0000AT0190E		150	79x96

CARRY BASKETS

PAPER HOLDERS FOR PAPER ROLLS

QUIVERS

HOLDER FOR GLOVES AND DISINFECTANT SOLUTION

DOOR STOPPERS

HOSES FOR BUCKET FILLING

NOTE BOARDS

HOOKS

BAGS

WHEELS

■ Bags with bottom grip

Plastified bag with bottom grip



REF.	NOTES	CAPACITY (L)	SIZE (cm) ↓ ↓ ↓
0000AT0120E		120	28x42x98

■ Bags with strap tape system

90l self-standing bag with strap tape system



REF.	NOTES
0000AT0185E	

For Morgan Hotel Light trolley bag holder

■ Bags with eyelets and zipper

Self-supporting plastified bag with eyelets and zipper



REF.	NOTES	CAPACITY (L)	SIZE (cm) ↓ ↓ ↓
0000AT0180C		120	60x79
0000AT0180U		120	60x79

For bag holder 120 L of Alpha trolleys

Yellow color available while supplies last



CARRY BASKETS

PAPER HOLDERS FOR PAPER ROLLS

QUIVERS

HOLDER FOR GLOVES AND DISINFECTANT SOLUTION

DOOR STOPPERS

HOSES FOR BUCKET FILLING

NOTE BOARDS

HOOKS

BAGS

WHEELS

Plastified bags 50 L

Plastified bag



REF.	NOTES	CAPACITY (L)	SIZE (cm) ↓ ↓ ↓
0000AT0110A		50	60x32x64,5
0000AT0110B		50	60x32x64,5
0000AT0110E		50	60x32x64,5

Mesh bags

Mesh bag with closing string



REF.	NOTES	CAPACITY (L)	SIZE (cm) ↓ ↓ ↓
0000AT0210A	polypropylene	30	30x60
0000AT0210B	polypropylene	30	30x60
0000AT0210C	polypropylene	30	30x60
0000AT0210F	polypropylene	30	30x60
0000AT0211A	polyester	50	30x90
0000AT0211B	polyester	50	30x90
0000AT0212A	stabilized polyester	70	60x90
0000AT0212B	stabilized polyester	70	60x90
0000AT0214B	stabilized polyester	35	65x46

Ideal for supports art. P1909914U, P1909926U and P1909927U

Polyester bags

White polyester bag with coloured stripe



REF.	NOTES	CAPACITY (L)	SIZE (cm) ↓ ↓ ↓
8057A		150	90x94
8057B		150	90x94
8057C		150	90x94
8057F		150	90x94

For housekeeping trolleys

Bags for laundry collection

White polyester bag with strings and button, with open side and coloured stripe, for laundry collection trolleys



REF.	NOTES	CAPACITY (L)	SIZE (cm) ↓ ↓ ↓
8181A	with blue stripe		54x101
8181B	with red stripe		54x101
8181C	with yellow stripe		54x101
8181F	with green stripe		54x101

CARRY BASKETS

PAPER HOLDERS FOR PAPER ROLLS

QUIVERS

HOLDER FOR GLOVES AND DISINFECTANT SOLUTION

DOOR STOPPERS

HOSES FOR BUCKET FILLING

NOTE BOARDS





HOOKS

BAGS

WHEELS

White polyester bag with strings and button, completely closed, for laundry collection trolleys



REF.	NOTES		SIZE (cm) ↓ ↓ ↓
8182A	with blue stripe		81x101
8182B	with red stripe		81x101
8182C	with yellow stripe		81x101
8182F	with green stripe		81x101

Plastified bag for "X" laundry collection trolley



REF.	NOTES	CAPACITY (L)	SIZE (cm) ↓ ↓ ↓
8052	for art. 8043	150	47x34x90
8052/1	for art. 8044	180	51x39x82

Plastified bag with front opening for foldable X-trolley for laundry collection



REF.	NOTES	CAPACITY (L)
Q0400131E		200
Q0400132E		100

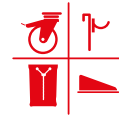

CARRY BASKETS

PAPER HOLDERS FOR PAPER ROLLS

QUIVERS

HOLDER FOR GLOVES AND DISINFECTANT SOLUTION

DOOR STOPPERS

HOSES FOR BUCKET FILLING

NOTE BOARDS

HOOKS

BAGS

WHEELS

■ Different wheels

Wheel ø 35 mm



REF.	NOTES
2793	for Prisma, Twin, Top-Down®, Pick-Up, Trend and art. 0000SE1428

Wheel ø 50 mm



REF.	NOTES
7949	For King, Spider, Ro-cket Wheels, Duo Pro System, Prisma, Twin, Top-Down®, Pick-Up, Trend and code 0000SE1428

Kit wheels and bumpers for laundry collection trolleys art. 3105-3106



REF.	NOTES
0000SM00312	

Wheel ø 80 mm



REF.	NOTES
8063	1. for Jack, Mini Jack, Filmop, Scala, Panda trolleys, laundry trolleys, trolleys for wax application and art. 8042 - 8042/1
8063/7	2. for OneFred, Fred, Orion, Vega, Arka, Jumpy, Oscar, Twice and Maxi Jolly trolleys
8063/6	3. for Baby
8063/4	4. for art. 8045 and 8070

For even indoor floors

Wheel ø 80 mm with brake



REF.	NOTES
8063/3	1. for Jack, Mini Jack, Filmop, Scala, Panda trolleys, laundry trolleys, trolleys for wax application and art. 8042 - 8042/1
8063/9	2. for Baby
8063/10	3. for art. 8045 and 8070

For even indoor floors

CARRY BASKETS

PAPER HOLDERS FOR PAPER ROLLS

QUIVERS

HOLDER FOR GLOVES AND DISINFECTANT SOLUTION

DOOR STOPPERS

HOSES FOR BUCKET FILLING

NOTE BOARDS

HOOKS

BAGS

WHEELS

Wheel ø 100 mm



REF.	NOTES
8064	1. for Teddy, Jumbo and Ecology trolleys
8064/3	2. for Morgan trolleys

For even indoor floors

Wheel ø 100 mm with brake



REF.	NOTES
8064/1	1. for Teddy, Jumbo and Ecology trolleys
8064/8	2. for Morgan trolleys

For even indoor floors

Wheel Ø 100x28 mm

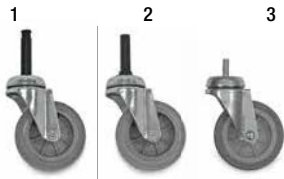

REF.	NOTES
23011262	1. for Alpha and Silver trolleys
33011262	2. for Morgan trolleys
94001262	3. for Teddy, Jumbo, Ecology and Panda trolleys

For even indoor and outdoor floors

Wheel Ø 100x28 mm with brake

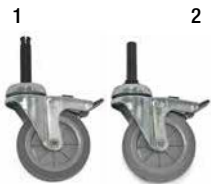

REF.	NOTES
23011272	1. for Alpha and Silver trolleys
33011272	2. for Morgan trolleys

For even indoor and outdoor floors

Wheel ø 125x28 mm



REF.	NOTES
2795	1. for Teddy, Jumbo, Ecology and Panda trolleys
23011250	2. for Alpha and Emotion trolleys
33011250	3. for Morgan trolleys
13011310	4. for supporting plate art. P314001U - Morgan Hotel trolleys

For even indoor and outdoor floors

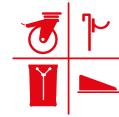

CARRY BASKETS

PAPER HOLDERS FOR PAPER ROLLS

QUIVERS

HOLDER FOR GLOVES AND DISINFECTANT SOLUTION

DOOR STOPPERS

HOSES FOR BUCKET FILLING

NOTE BOARDS

HOOKS

BAGS

WHEELS

Wheel ø 125x28 mm with brake



REF.	NOTES
2795/1	1. for Teddy, Jumbo, Ecology and Panda trolleys
23011251	2. for Alpha and Emotion trolleys
33011251	3. for Morgan trolleys

For even indoor and outdoor floors

Rubber wheel ø 125 mm



REF.	NOTES
24011298	1. for Alpha and Silver trolleys
34011274	2. for Morgan trolleys
54011274	3. for supporting plastic plate ref. P314005U - for Morgan Hotel trolleys
64011274Q	4. for supporting plastic plate ref. P075130Q - for Emotion trolleys
94001298	5. for Teddy, Jumbo, Ecology and Panda trolleys

Quiet castors for indoor floors

Rubber wheel ø 125 mm with brake



REF.	NOTES
24011299	1. for Alpha and Silver trolleys
34011283	2. for Morgan trolleys

Quiet castors for indoor floors

ø 150 mm rubber wheel



REF.	NOTES
24011295	1. for Alpha and Silver trolleys
34011276	2. for Morgan trolleys
64011276Q	3. for plate art. P075130Q for Emotion trolleys

Quiet castors for indoor floors - Can take heavy loads

Rubber wheel ø 150 mm with brake



REF.	NOTES
24012296	1. for Alpha and Silver trolleys
34012301	2. for Morgan trolleys

Quiet castors for indoor floors - Can take heavy loads

Castors for bumper ø 130

125mm ø rubber castor with long pin for bumper item no. P190611U



REF.	NOTES
84011298	for Alpha and Silver trolleys

125mm ø rubber castor with long pin for bumper item no. P190611U lockable



REF.	NOTES
84011299	for Alpha and Silver trolleys

Wheels for maxi bumper

Rubber wheel ø 125 mm with long pin for bumper art. P190610U



REF.	NOTES
44011298	1. for Alpha trolleys
44011298Q	2. for Emotion trolleys

Quiet castors for indoor floors

Rubber wheel ø 125 mm with long pin for bumper art. P190610U and brake



REF.	NOTES
44011299	1. for Alpha trolleys
44011299Q	2. for Emotion trolleys

Quiet castors for indoor floors

Rubber wheel ø 150 mm with long pin for bumpers ref. P190610U



REF.	NOTES
44011295	1. for Alpha trolleys
44011295Q	2. for Emotion trolleys

Quiet castors for indoor floors - Can take heavy loads

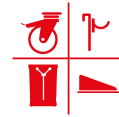

CARRY BASKETS

PAPER HOLDERS FOR PAPER ROLLS

QUIVERS

HOLDER FOR GLOVES AND DISINFECTANT SOLUTION

DOOR STOPPERS

HOSES FOR BUCKET FILLING

NOTE BOARDS

HOOKS

BAGS

WHEELS

Rubber wheel \varnothing 150 mm with long pin for bumpers ref. P190610U and brake

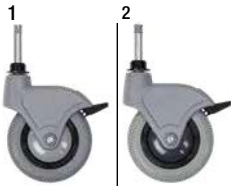

REF.	NOTES
44012301	1. for Alpha trolleys
44012301Q	2. for Emotion trolleys

Quiet castors for indoor floors - Can take heavy loads

Wheels with plate

Wheel \varnothing 100x28 mm with flange



REF.	NOTES
23011282	1. with rotating plate - for Alpha and Emotion (long base), Morgan and Morgan Hotel trolleys
23011284	2. with fixed plate - for Alpha and Emotion (long base), Morgan and Morgan Hotel trolleys
23011278	3. with rotating plate and brake - for Alpha and Emotion (long base), Morgan and Morgan Hotel trolleys

For even indoor and outdoor floors

\varnothing 125 mm wheel with plate



REF.	NOTES
23011309	1. with rotating plate - for Alpha and Emotion (long base), Morgan and Morgan Hotel trolleys
23011314	2. with fixed plate - for Alpha and Emotion (long base), Morgan and Morgan Hotel trolleys
23011315	3. with rotating plate and brake - for Alpha and Emotion (long base), Morgan and Morgan Hotel trolleys

Rubber wheel \varnothing 125 mm with plate



REF.	NOTES
24011293	1. with rotating plate - for Alpha and Emotion (long base), Morgan and Morgan Hotel trolleys
24011294	2. with fixed plate - for Alpha and Emotion (long base), Morgan and Morgan Hotel trolleys
24011292	3. with rotating plate and brake - for Alpha and Emotion (long base), Morgan and Morgan Hotel trolleys

Quiet castors for indoor floors

Rubber wheel \varnothing 150 mm with plate



REF.	NOTES
24011264	1. with rotating plate - for Alpha and Emotion (long base), Morgan and Morgan Hotel trolleys
24011266	2. with fixed plate - for Alpha and Emotion (long base), Morgan and Morgan Hotel trolleys

Quiet smooth-gliding castors for indoor floors, including uneven floors

CARRY BASKETS

PAPER HOLDERS FOR PAPER ROLLS

QUIVERS

HOLDER FOR GLOVES AND DISINFECTANT SOLUTION

DOOR STOPPERS

HOSES FOR BUCKET FILLING

NOTE BOARDS

HOOKS

BAGS

WHEELS

Wheel ø 200x45 mm with plate



REF.	NOTES
23011290	1. with rotating plate - for Alpha and Emotion trolleys (long base)
23011289	2. with fixed plate - for Alpha and Emotion trolleys (long base)

For indoor floors - Can take heavy loads - Can also be used on carpet

Rubber wheel for outdoor use ø 200x50 mm with plate



REF.	NOTES
23011285	1. with rotating plate - for Alpha, Emotion and Morgan (big base)
23011286	2. with fixed plate - for Alpha, Emotion and Morgan trolleys (long base)

For outdoor floors - Can take heavy loads - Need special support bars in order to set up

Rubber wheel ø 200x50 mm with plate



REF.	NOTES
23011311	with rotating plate - for Alpha and Emotion Drive trolleys

They bear heavy weights

Rubber wheel for outdoor use ø 260x75 mm with plate



REF.	NOTES
23011291	1. with rotating plate - for Alpha, Emotion and Morgan (big base)
23011308	2. with fixed plate - for Alpha, Emotion and Morgan trolleys (long base)

For outdoor floors - Can take heavy loads - Need special support bars in order to set up

■ Axial wheels

ø 175 mm wheel



REF.	NOTES
2797	1. for Scala and Panda trolleys
2798	2. for trolleys art. 8076-8077

Set of axial wheels ø 200 mm complete with screws

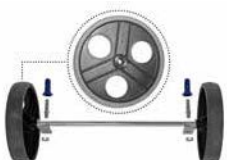

REF.	NOTES
0000SM00128	for plastic mopping trolleys



CARRY BASKETS

PAPER HOLDERS FOR PAPER ROLLS

QUIVERS

HOLDER FOR GLOVES AND DISINFECTANT SOLUTION

DOOR STOPPERS

HOSES FOR BUCKET FILLING

NOTE BOARDS

HOOKS

BAGS

WHEELS

Bumpers

Maxi bumper \varnothing 200 mm with rubber profile



REF.	NOTES
P190610U	for Alpha trolleys with wheels with long pin
P190610Q	for Emotion trolleys with wheels with long pin

Plastic bumper



REF.	NOTES
8065A	for mopping trolleys, single buckets, Panda and Teddy trolleys

Bumper with rubber outside



REF.	NOTES
8095	for Jumbo and Ecology trolleys

Bumper \varnothing 85 mm



REF.	NOTES
P190600A	for Morgan trolleys 
P190600U	for Morgan Hotel trolleys 

Bumper \varnothing 130 mm



REF.	NOTES
P190611U	for Silver and Alpha trolleys with wheels with long pin and Morgan Hotel



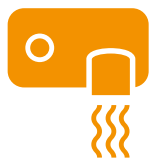

Hygiene line

- Hand towel dispensers
- Toilet paper dispensers
- Soap-sanitiser dispensers
- Hairdryers
- Air hand dryers
- Bathroom accessories
- Hand hygiene floor stands

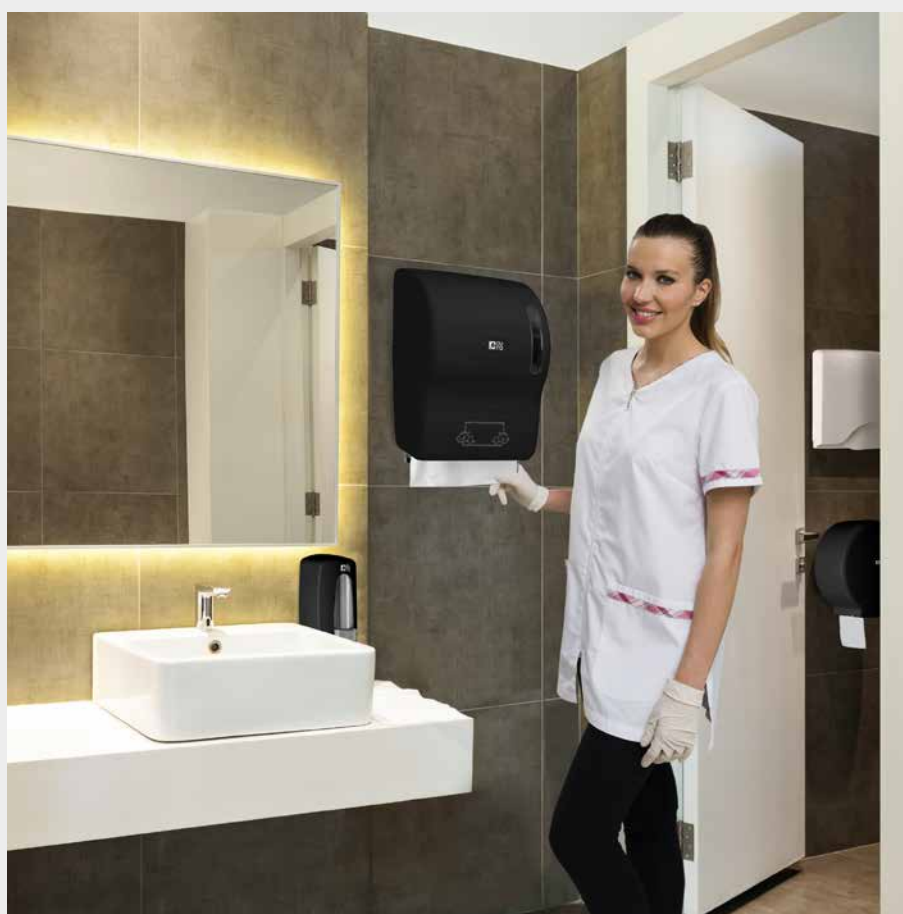



Aura: bathroom furnishing with style!



Aura is a line of products particularly used in bathrooms.

Impeccable bathroom furnishing, elegant and functional at the same time

- **STYLE:** the products of the Aura range feature stylish materials and different shades, capable of meeting all needs and offering perfect integration in all environments
- **ERGONOMICS:** what sets Aura apart is the ergonomic design, specifically conceived to make each product intuitive and easy to use.
- **HYGIENE:** Aura items and accessories have rounded shapes and smooth surfaces, making cleaning and maintenance easier and facilitating the preservation of hygiene standards

Fresh and Deluxe

Fresh e Deluxe line are characterized by a minimal design and the possibility **to customize the products** used in bathrooms by printing one's own logo in the specific inlay.



HAND TOWEL DISPENSERS

TOILET PAPER DISPENSERS

SOAP-SANITISER DISPENSERS

HAIRDRYERS

AIR HAND DRYERS

BATHROOM ACCESSORIES

HAND HYGIENE FLOOR STANDS

Stainless steel hand towel dispensers

Hand towel dispenser **TRAIL LINE** stainless steel for "C" or "Z" - shaped paper towels



REF.	NOTES	PCK	VOLUME (m³)	GROSS WEIGHT (kg)	SIZE (cm) ↓ ↓ ↓
AU1MS010A0	capacity 600 pcs	1	0,014	2,15	13,3x26,1x34,2

Hand towel dispenser **TRAIL LINE** stainless steel for towel roll ø 205 mm



REF.	NOTES	PCK	VOLUME (m³)	GROSS WEIGHT (kg)	SIZE (cm) ↓ ↓ ↓
AU1MR100A0		1	0,02	2,77	25x23x32

Hand towel dispenser **TRAIL LINE** stainless steel for towel roll ø 130 mm



REF.	NOTES	PCK	VOLUME (m³)	GROSS WEIGHT (kg)	SIZE (cm) ↓ ↓ ↓
AU1MR300A0		1	0,006	1,51	14x15x28

White plastic hand towel dispensers

Hand towel dispenser **SNOW LINE** white plastic (ABS) for "C" or "Z" - shaped paper towels and paper roll ø 120 mm



REF.	NOTES	PCK	VOLUME (m³)	GROSS WEIGHT (kg)	SIZE (cm) ↓ ↓ ↓
AU1MD010P0	Capacity: 400 pcs / 1 roll ø 120 mm and 23, mm long	1	0,006	1,07	18x26x26

Hand towel dispenser **FRESH LINE** in white plastic (ABS) for "C" or "Z" - shaped paper towels



REF.	NOTES	PCK	VOLUME (m³)	GROSS WEIGHT (kg)	SIZE (cm) ↓ ↓ ↓
AU1MS020P0	capacity 600 pcs	1	0,014	0,85	13x27,5x36,5

Hand towel dispenser **SNOW LINE** white plastic (ABS) for towel roll ø 130 mm



REF.	NOTES	PCK	VOLUME (m³)	GROSS WEIGHT (kg)	SIZE (cm) ↓ ↓ ↓
AU1MR300P0		1	0,009	0,57	13,9x14,1x28,7

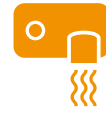

HAND TOWEL DISPENSERS

TOILET PAPER DISPENSERS

SOAP-SANITISER DISPENSERS

HAIRDRYERS

AIR HAND DRYERS

BATHROOM ACCESSORIES

HAND HYGIENE FLOOR STANDS

Hand towel dispenser **FRESH LINE** in white plastic (ABS) for towel roll ø 205 mm



REF.	NOTES	PCK	VOLUME (m³)	GROSS WEIGHT (kg)	SIZE (cm) ↓ ↓ ↓
AU1MR010P0		1	0,02	1,09	23x23x33,4

FRESH LINE in white plastic (ABS) dispenser for ø 210 mm paper towel roll with automatic cutter



REF.	NOTES	PCK	VOLUME (m³)	GROSS WEIGHT (kg)	SIZE (cm) ↓ ↓ ↓
AU1MR900P0		1	0,03	2,51	23,5x28,5x36

Black plastic dispensers for paper towels

Hand towel dispenser **DELUXE LINE** in black plastic (ABS) for "C" or "Z" - shaped paper towels



REF.	NOTES	PCK	VOLUME (m³)	GROSS WEIGHT (kg)	SIZE (cm) ↓ ↓ ↓
AU1MS020P7	capacity 600 pcs	1	0,015	0,85	13x27,5x36,5

Hand towel dispenser **DELUXE LINE** in black plastic (ABS) for towel roll ø 205 mm



REF.	NOTES	PCK	VOLUME (m³)	GROSS WEIGHT (kg)	SIZE (cm) ↓ ↓ ↓
AU1MR010P7		1	0,02	1,09	23x23x33,4

DELUXE LINE in black plastic (ABS) dispenser for ø 210 mm paper towel roll with automatic cutter



REF.	NOTES	PCK	VOLUME (m³)	GROSS WEIGHT (kg)	SIZE (cm) ↓ ↓ ↓
AU1MR900P7		1	0,03	2,51	23,5x28,5x36

Stainless steel toilet paper dispensers

Toilet paper dispenser **TRAIL LINE** stainless steel for toilet paper roll \varnothing 220 mm 300 mt long



REF.	NOTES	PCK	VOLUME (m ³)	GROSS WEIGHT (kg)	SIZE (cm) ↓ ↓ ↓
AU1CR020A0	\varnothing 27 x 12,8 cm	1	0,011	1,44	12,8

\varnothing fitting mandrel: 45 mm - 55 mm - 76 mm (76 mm with adaptor art. AU9C0004P0)

Toilet paper dispenser **TRAIL LINE** stainless steel for standard toilet paper roll



REF.	NOTES	PCK	VOLUME (m ³)	GROSS WEIGHT (kg)	SIZE (cm) ↓ ↓ ↓
AU1CR500A0	capacity 2 rolls	1	0,005	1,47	14x15x28

TRAIL LINE stainless steel dispenser for interfold toilet paper



REF.	NOTES	PCK	VOLUME (m ³)	GROSS WEIGHT (kg)	SIZE (cm) ↓ ↓ ↓
AU1CS010A0	capacity 400 pcs	1	0,008	1,46	14x14,5x28

White plastic toilet paper dispensers

Toilet paper dispenser **FRESH LINE** in white plastic (ABS) for maxi toilet paper roll



REF.	NOTES	PCK	VOLUME (m ³)	GROSS WEIGHT (kg)
AU1CR010P0	\varnothing 27.5 x 12 cm - for roll \varnothing 220 mm, 300 mt long	1	0,01	0,61
AU1CR030P0	\varnothing 33.5 x 12.5 cm - For rolls \varnothing 260 mm, length 400 m	1	0,016	0,77

\varnothing fitting mandrel: 45 mm - 55 mm - 76 mm (76 mm with adaptor art. AU9C0004P0)

Toilet paper dispenser **SNOW LINE** white plastic (ABS) for standard toilet paper roll



REF.	NOTES	PCK	VOLUME (m ³)	GROSS WEIGHT (kg)	SIZE (cm) ↓ ↓ ↓
AU1CR500P0	capacity 2 rolls	1	0,006	0,34	13,8x14,1x28,7

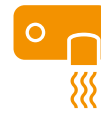

HAND TOWEL
DISPENSERS

**TOILET PAPER
DISPENSERS**

**SOAP-SANITISER
DISPENSERS**

HAIRDRYERS

AIR HAND DRYERS

BATHROOM
ACCESSORIES

HAND HYGIENE FLOOR
STANDS

FRESH LINE white plastic (ABS) dispenser for interfold toilet paper



REF.	NOTES	PCK	VOLUME (m³)	GROSS WEIGHT (kg)	SIZE (cm) ↓ ↓ ↓
AU1CS020P0	capacity 400 pcs	1	0,006	0,52	14,5x12,1x28,6

Black plastic dispensers for toilet paper

Toilet paper dispenser **DELUXE LINE** in black plastic (ABS) for maxi toilet paper roll



REF.	NOTES	PCK	VOLUME (m³)	GROSS WEIGHT (kg)
AU1CR010P7	ø 27.5 x 12 cm - for roll ø 220 mm, 300 mt long	1	0,01	0,61
AU1CR030P7	ø 34 x 12.5 cm - for roll ø 260 mm, 400 mt long	1	0,016	0,77

ø fitting mandrel: 45 mm - 55 mm - 76 mm (76 mm with adaptor art. AU9C0004P0)

DELUXE LINE black plastic (ABS) dispenser for interfold toilet paper



REF.	NOTES	PCK	VOLUME (m³)	GROSS WEIGHT (kg)	SIZE (cm) ↓ ↓ ↓
AU1CS020P7	capacity 400 pcs	1	0,006	0,52	14,5x12,1x28,6

Stainless steel soap/sanitiser dispensers

TRAIL LINE stainless steel distributor for soap/sanitiser



REF.	NOTES	PCK	VOLUME (m³)	GROSS WEIGHT (kg)	SIZE (cm) ↓ ↓ ↓
AU3GP020A0	capacity 0.80 L	1	0,006	1,15	11x12,7x27,1

White plastic soap/sanitiser dispensers

JOLLY LINE white plastic (ABS) distributor for soap/sanitiser



REF.	NOTES	PCK	VOLUME (m³)	GROSS WEIGHT (kg)	SIZE (cm) ↓ ↓ ↓
AU3GP200P0	capacity 0.9 L	10	0,04	4,29	9,5x13x23,3

HAND TOWEL
DISPENSERS

TOILET PAPER
DISPENSERS

**SOAP-SANITISER
DISPENSERS**

HAIRDRYERS

AIR HAND DRYERS

BATHROOM
ACCESSORIES

HAND HYGIENE FLOOR
STANDS

Foam soap dispenser **SNOW LINE** white plastic (ABS)



REF.	NOTES	PCK	VOLUME (m³)	GROSS WEIGHT (kg)	SIZE (cm) ↓ ↓ ↓
AU3SP100P0	capacity 0,8 L	1	0,004	0,67	10,7x25x33,5

FRESH LINE white plastic (ABS) distributor for soap/sanitiser



REF.	NOTES	PCK	VOLUME (m³)	GROSS WEIGHT (kg)	SIZE (cm) ↓ ↓ ↓
AU3GP100P0	capacity 1 L	1	0,004	0,38	8,9x11,9x23,6

SENSOR - automatic dispenser in white plastic (ABS) for detergent/disinfectant



REF.	NOTES	PCK	VOLUME (m³)	GROSS WEIGHT (kg)	SIZE (cm) ↓ ↓ ↓
AU3GA100P0	capacity 1 L	12	0,064	9,92	12x12,3x26,5



Black plastic soap/sanitiser dispensers

DELUXE LINE black plastic (ABS) distributor for soap/sanitiser



REF.	NOTES	PCK	VOLUME (m³)	GROSS WEIGHT (kg)	SIZE (cm) ↓ ↓ ↓
AU3GP100P7	capacity 1 L	1	0,004	0,46	8,9x11,9x23,6

DELUXE LINE CONTROL black plastic (ABS) distributor for soap/sanitiser



REF.	NOTES	PCK	VOLUME (m³)	GROSS WEIGHT (kg)	SIZE (cm) ↓ ↓ ↓
AU3GP200P7	capacity 0.9 L	1	0,003	0,49	10x13x23,5



HAND TOWEL
DISPENSERS

TOILET PAPER
DISPENSERS

SOAP-SANITISER
DISPENSERS

HAIRDRYERS

AIR HAND DRYERS

BATHROOM
ACCESSORIES

HAND HYGIENE FLOOR
STANDS

■ Hairdryer with button

Hairdryer **DELUXE LINE** in black plastic (ABS) with bag



REF.	NOTES	PCK	VOLUME (m³)	GROSS WEIGHT (kg)	SIZE (cm) ↓ ↓ ↓
AU5HP310P7	Overall power: 1800 W	1	0,004	0,73	20,5x10x22

Hairdryer with button **SNOW LINE** white plastic (ABS)



REF.	NOTES	PCK	VOLUME (m³)	GROSS WEIGHT (kg)	SIZE (cm) ↓ ↓ ↓
AU5HP300P0	power 1200 W, class II	1	0,005	0,76	13x13x14,5

Hairdryer dimensions 17x7x18 cm, support dimensions 13x13x14,5 cm

■ Automatic air hand dryers

Automatic air hand dryer **TRAIL LINE** stainless steel



REF.	NOTES	PCK	VOLUME (m³)	GROSS WEIGHT (kg)	SIZE (cm) ↓ ↓ ↓
AU5MA010A0	power 2000 W, class II	1	0,028	4,06	22x28x21

Installation cable not included

Automatic air hand dryers **CLASSIC LINE** white laquered



REF.	NOTES	PCK	VOLUME (m³)	GROSS WEIGHT (kg)	SIZE (cm) ↓ ↓ ↓
AU5MA010V0	power 2000 W, class II	1	0,025	4,9	22x28x21

Installation cable not included

Automatic air hand dryer **TRAIL LINE** stainless steel



REF.	NOTES	PCK	VOLUME (m³)	GROSS WEIGHT (kg)	SIZE (cm) ↓ ↓ ↓
AU5MA100A0	power 2000 W, class I	1	0,028	4,1	14x23x31

Installation cable not included

HAND TOWEL
DISPENSERS

TOILET PAPER
DISPENSERS

SOAP-SANITISER
DISPENSERS

HAIRDRYERS

AIR HAND DRYERS

BATHROOM
ACCESSORIES

HAND HYGIENE FLOOR
STANDS

Automatic air hand dryer **SNOW LINE** white plastic (ABS)



REF.	NOTES	PCK	VOLUME (m³)	GROSS WEIGHT (kg)	SIZE (cm) ↓ ↓ ↓
AU5MA100P0	power 2000 W, class II	1	0,027	3,6	14x23x31

Installation cable not included

SNOW LINE automatic high-pressure hand dryer made of white plastic (ABS)



REF.	NOTES	PCK	VOLUME (m³)	GROSS WEIGHT (kg)	SIZE (cm) ↓ ↓ ↓
AU5MA200P0	Overall power: 1400 w	1	0,028	4	17x26,5x33

Installation cable not included

SNOW LINE ERGONOMIC automatic high-pressure hand dryer made of white plastic (ABS)



REF.	NOTES	PCK	VOLUME (m³)	GROSS WEIGHT (kg)	SIZE (cm) ↓ ↓ ↓
AU5MA500P0	power 1550 W, class II	1	0,062	8,49	18x32x54

Installation cable not included

Air hand dryers with button

Air hand dryers with button **TRAIL LINE** stainless steel



REF.	NOTES	PCK	VOLUME (m³)	GROSS WEIGHT (kg)	SIZE (cm) ↓ ↓ ↓
AU5MP010A0	power 2000 W, class II	1	0,028	4,06	22x28x21

Installation cable not included

Air hand dryers with button **TRAIL LINE** white lacquered



REF.	NOTES	PCK	VOLUME (m³)	GROSS WEIGHT (kg)	SIZE (cm) ↓ ↓ ↓
AU5MP010V0	power 2000 W, class II	1	0,025	4,93	22x28x21

Installation cable not included



HAND TOWEL
DISPENSERS

TOILET PAPER
DISPENSERS

SOAP-SANITISER
DISPENSERS

HAIRDRYERS

AIR HAND DRYERS

**BATHROOM
ACCESSORIES**

HAND HYGIENE FLOOR
STANDS

Sanitary towel bag dispensers

Sanitary towel bag dispenser **SNOW LINE** white plastic (ABS)



REF.	NOTES	PCK	VOLUME (m³)	GROSS WEIGHT (kg)	SIZE (cm) ↓ ↓ ↓
AU1AW200P0	capacity: 1 recharge with 25 bags	1	0,001	0,27	6,5x13x13,5

Available while stocks last

High density polyethylene sanitary towel bags



REF.	NOTES	PCK	VOLUME (m³)	GROSS WEIGHT (kg)	SIZE (cm) ↓ ↓ ↓
AU9PAC1000	pck: 48 recharges with 25 bags	1	0,012	1,73	12,5x9x2

Toilet seat cover dispensers

Toilet seat cover dispenser **SNOW LINE** white plastic (ABS)



REF.	NOTES	PCK	VOLUME (m³)	GROSS WEIGHT (kg)	SIZE (cm) ↓ ↓ ↓
AU1AW210P0	capacity: 125 tissue paper	1	0,043	1,38	4x42x31

Toilet brush

Toilet brush **TRAIL LINE** stainless steel



REF.	NOTES	PCK	VOLUME (m³)	GROSS WEIGHT (kg)	SIZE (cm) ↓ ↓ ↓
AU1AW220A0	ø 9 x 39 cm	1	0,004	0,89	39

Dispenser accessories

Blank insert for Fresh and Deluxe line



REF.	NOTES	PCK	VOLUME (m³)	GROSS WEIGHT (kg)
AU9PRS1021		1	-	0,04
AU9PRS1020		500	0,012	21

HAND TOWEL
DISPENSERS

TOILET PAPER
DISPENSERS

SOAP-SANITISER
DISPENSERS

HAIRDRYERS

AIR HAND DRYERS

BATHROOM
ACCESSORIES

HAND HYGIENE FLOOR
STANDS

Adaptor for toilet paper roll with mandrel \varnothing 76 mm



REF.	NOTES	PCK	GROSS WEIGHT (kg)
AU9C0004P0		1	0,02

Floor stands

DISPLAY - stand with compartments for disinfectant, disposable gloves and check-list holder



REF.	NOTES	PCK	VOLUME (m ³)	GROSS WEIGHT (kg)	SIZE (cm) ↓ ↓ ↓
00PV0010		1	0,041	9,12	29x29x129



⚠ ATTENTION: sanitiser, gloves and worksheet not included

SLIM - stand for Jolly Line dispenser



REF.	NOTES	PCK	VOLUME (m ³)	GROSS WEIGHT (kg)	SIZE (cm) ↓ ↓ ↓
AU3KP100V7		1	0,03	7,78	40x40x133,5



⚠ ATTENTION: dispenser cod. AU3GP200P0 not included

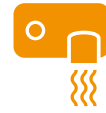

HAND TOWEL
DISPENSERS

TOILET PAPER
DISPENSERS

SOAP-SANITISER
DISPENSERS

HAIRDRYERS

AIR HAND DRYERS

BATHROOM
ACCESSORIES

**HAND HYGIENE FLOOR
STANDS**

Touch free floor stands

TANK-PEDAL - painted stand with pedal pump



REF.	NOTES	PCK	VOLUME (m³)	GROSS WEIGHT (kg)	SIZE (cm) ↓ ↓ ↓
00PV0031	for 5 L tank - sizes tank compartment cm 19,2 x 13,5 x 33 h	1	0,13	13,8	37,5x27,5x103
00PV0041	for 10 L tank - sizes tank compartment cm 24x20,5x38 h	1	0,243	16,22	43x34,5x103



ATTENTION: Disinfectant tank not included

SLIM SENSOR - stand for Sensor automatic dispenser



REF.	NOTES	PCK	VOLUME (m³)	GROSS WEIGHT (kg)	SIZE (cm) ↓ ↓ ↓
AU3KA100V7		1	0,037	7,74	40x40x136



ATTENTION: dispenser cod. AU3GA100P0 not included



Index by item number

TECHNICAL CATALOGUE 2023-2024

Index by item number

REF.	PAGES	REF.	PAGES	REF.	PAGES
000010100YU	41	0000204A	84	00009012CD	49
000010104A	39	0000205A	84	00009012DD	49
000010104B	39	0000214AA	86, 141	00009012FD	49
000010104C	39	0000214BB	86, 141	00009013AD	49
000010104F	39	0000214CC	86, 141	00009013AH	49
000010104H	39	0000214FF	86, 141	00009013BD	49
000010105A	40	0000264A	84	00009013CD	49
000010105B	40	0000265A	84	00009013DD	49
000010105C	40	0000311AA	76	00009013FD	49
000010105F	40	0000311BB	76	00009014AD	49
000010105H	40	0000311CC	76	00009014AH	49
000010105U	40, 337	0000311D	76	00009014BD	49
000010124A	38	0000311FF	76	00009014CD	49
000010124H	38	0000312D	76	00009014DD	49
000010125A	38	0000511D	76	00009014FD	49
000010125H	38	0000512D	76	00009312DD	49
000010404A	39	5830	353	00009313AD	49
000010404B	39	5835	353	00009313BD	49
000010404H	39	5836	353	00009313CD	49
000010405A	39	0000611D	68	00009313DD	49
000010405B	39	0000612D	69	00009313FD	49
000010405H	39	00008116AB	65	00009314DD	49
0000121AA	68	00008316AB	65	0000AM30005	149
0000121BB	68	00008916AB	66	0000AM30010	149
0000121CC	68	00009011AD	49	0000AM30015	149
0000121D	68	00009011AH	49	0000AM30015B	149
0000121FF	68	00009012AD	49	0000AM30015C	149
0000122D	69	00009012AH	49	0000AM30015F	149
000020100YU	41	00009012BD	49	0000AM30015U	149

REF.	PAGES	REF.	PAGES	REF.	PAGES
0000AM30020	149	0000AT0180C	474	0000CO2017DE	364
0000AM30025	149	0000AT0180U	474	0000CO2023DE	364
0000AM3040FZ	147, 332	0000AT0185E	404, 474	0000CO2025D	364
0000AM3045A	146	0000AT0190A	473	0000CO2090I	359
0000AM3045UA	146	0000AT0190B	473	0000CO2091I	359
0000AM3045UB	146	0000AT0190E	473	0000CO2092I	359
0000AM3045UC	146	0000AT0200A	473	0000CO2093I	359
0000AM3045UF	146	0000AT0200B	473	0000CO2094I	359
0000AM3045UU	146	0000AT0210A	55, 475	0000CO2120D	362
0000AM3060A	147	0000AT0210B	55, 475	0000CO2120F	362
0000AM3070A	124, 146, 168	0000AT0210C	55, 475	0000CO2190I	359
0000AM3070UA	124, 146, 168	0000AT0210F	55, 475	0000CO2191I	359
0000AM3070UB	124, 146, 168	0000AT0211A	55, 475	0000CO2192I	359
0000AM3070UC	124, 146, 168	0000AT0211B	55, 475	0000CO2193I	359
0000AM3070UF	124, 146, 168	0000AT0212A	55, 475	0000CO2194I	359
0000AM3070UU	124, 146, 168	0000AT0212B	55, 475	0000CO2240D	362
0000AM3090A	124, 146, 168	0000AT0214B	114, 55, 475	0000CO2240F	362
0000AM3170A	146	0000AT0300A	473	0000CO2910DE	363
0000AS21150A	120	0000AT0300B	473	0000CO3023D	364
0000AT0110A	475	0000AT0310A	473	0000CO3030D	347
0000AT0110B	475	0000AT0310B	473	0000CO3031D	347
0000AT0110E	475	0000CO1017D	350	0000CO3032D	347
0000AT0120E	447, 474	0000CO1023D	350	0000CO3033D	347
0000AT0160A	473	0000CO1120D	362	0000CO3034D	347
0000AT0160B	473	0000CO1120F	362	0000CO3035D	347
0000AT0160E	473	0000CO1240D	362	0000CO3036D	347
0000AT0170A	473	0000CO1240F	362	0000CO3060D	347
0000AT0170B	473	0000CO2010DE	363	0000CO3061D	347
0000AT0170E	473	0000CO2012U	353, 288	0000CO3062D	347

Index by item number

REF.	PAGES	REF.	PAGES	REF.	PAGES
0000C03063D	347	0000C03231D	348	0000C05050DUU	354
0000C03064D	347	0000C03232D	348	0000C05050U	354
0000C03065D	347	0000C03233D	348	0000C05150D	354
0000C03066D	347	0000C03234D	348	0000C05150U	354
0000C03090I	358	0000C03235D	348	0000C06170E	356
0000C03091I	358	0000C03236D	348	0000C07050D	342
0000C03092I	358	0000C03260D	348	0000C07050U1	342
0000C03093I	358	0000C03261D	348	0000C07150DC1	342
0000C03094I	358	0000C03262D	348	0000C07150DL1	342
0000C03130D	348	0000C03263D	348	0000C07250DB1	342
0000C03131D	348	0000C03264D	348	0000C07250DC1	342
0000C03132D	348	0000C03265D	348	0000C07250DF3	342
0000C03133D	348	0000C03266D	348	0000C07350DU	342
0000C03134D	348	0000C04120D	365	0000C07450DG1	342
0000C03135D	348	0000C04121D	365	0000C07450DU	342
0000C03136D	348	0000C04122D	365	0000C08050D	341
0000C03160D	348	0000C04123D	365	0000CP1104T	219
0000C03161D	348	0000C04124D	365	0000CP1108U	213
0000C03162D	348	0000C04220D	365	0000CP1114U	213
0000C03163D	348	0000C04221D	365	0000CP1122U	213
0000C03164D	348	0000C04222D	365	0000CP1128U	47, 208, 220
0000C03165D	348	0000C04223D	365	0000CP1204FZ	339
0000C03166D	348	0000C04224D	365	0000CP1204T	111, 219
0000C03190I	358	0000C05050D	354	0000CP1205T	111, 219
0000C03191I	358	0000C05050DUA	354	0000CP1206T	111, 219
0000C03192I	358	0000C05050DUB	354	0000D225000	58
0000C03193I	358	0000C05050DUC	354	0000D235000	58
0000C03194I	358	0000C05050DUD	354	0000D250000	58
0000C03230D	348	0000C05050DUF	354	0000D253000	58

REF.	PAGES	REF.	PAGES	REF.	PAGES
0000FD0501D	75	0000HP4273U	387	0000MA1100U00	226
0000FD0502D	75	0000HP4274U	387	0000MA1101U00	227
0000FD1401D	75	0000HP4304U	390	0000MA1102U00	377
0000FD1402D	75	0000HP4364U	392	0000MA1104U00	234
0000FD2401D	75	0000HP4366U	393	0000MA1105U00	234
0000FD2402D	75	0000HP4368U	394	0000MA1670U00	249
0000FS0122D	69	0000HP4373U	386	0000MA1673U00	249
0000GI2004A	43	0000HP4374U	386	0000MA2101U00	227
0000GI2104A	43	0000LF0030YU	170	0000MA2103U14	228
0000HA5302U98	412	0000LF0031YU	170	0000MA2672U00	250
0000HP3100U	396	0000LF0050YU	170	0000MA4101U00	229
0000HP3101U	398	0000LF0051YU	170	0000MA4103U00	236
0000HP3103U	398	0000LF1030YU	169	0000MA5101U00	229
0000HP3110Q5	447	0000LF1050YU	169	0000MA5107U00	237
0000HP3110U	397	0000LM30003	148	0000MA5108U18	238
0000HP3140U	397	0000LM30023	148	0000MA5110U00	239
0000HP3300U	388	0000LP0302A	174	0000MA5113U01	230
0000HP3301U	388	0000LP0303A	176	0000MA5671U00	251
0000HP3302U	389	0000LP0304A	174	0000MA6103U00	240
0000HP3303U	389	0000LP0305A	175	0000MA6105U00	230
0000HP3341U	395	0000LP0307A	175	0000MA6670U00	254
0000HP3342U	395	0000LP0308A	175	0000MA7103U00	379
0000HP3343U	396	0000LP0309A	175	0000MP1000A	290
0000HP3360U	390	0000LP0321A2	186	0000MP1010A	381
0000HP3361U	391	0000LP0322A2	186	0000MP1030U	381
0000HP3362U	391	0000LP1211A2	187	0000MP1040A	291
0000HP3363U	392	0000LP1221A2	187	0000MP1050A	292
0000HP3365U	393	0000LP1401C	160	0000MP1060A	292
0000HP3367U	394	0000LP1402C	160	0000MP2010A	293

Index by item number

REF.	PAGES	REF.	PAGES	REF.	PAGES
0000MP2050A	290	0000PN04012EZ	331	0000SE0204FBZ	336
0000MP2150A	293	0000PN0501	34	0000SE0204FCZ	336
0000MP3000A	291	0000PN0502	34	0000SE0204FFZ	336
0000MP3010A	294	0000SC00200	37	0000SE0204U	111, 217
0000MP3060A	294	0000SC00211	38	0000SE0204UA	111, 217
0000MP3080A	295	0000SC01020	40	0000SE0204UB	111, 217
0000MP4010A	295	0000SC01030	40	0000SE0204UC	111, 217
0000MP7010A	297	0000SC10200	37	0000SE0204UF	111, 217
0000MP7020A	297	0000SE0104A	216	0000SE0628U	207
0000MP8010A	296	0000SE0104B	216	0000SE0725UB	165
0000MP8020A	296	0000SE0104C	216	0000SE1128B	217
0000OM02230	58	0000SE0104F	216	0000SE1208A	212
0000OM02530	58	0000SE0104FAZ	336	0000SE1208B	212
0000PA0101C	469	0000SE0104FBZ	336	0000SE1208C	212
0000PA01020U	42	0000SE0104FCZ	336	0000SE1210A	212
0000PA0102C	469	0000SE0104FFZ	336	0000SE1210B	212
0000PA0104C	469	0000SE0106U	216	0000SE1214A	213
0000PA10300	37	0000SE0106UA	216	0000SE1214FT	213
0000PA10400	36	0000SE0106UB	216	0000SE1222A	46, 114, 125, 213
0000PA20300	37	0000SE0106UC	216	0000SE1222B	46, 114, 125, 213
0000PA20400	36	0000SE0106UF	216	0000SE1222FBZ	336
0000PN02016	123, 210	0000SE0108A	216	0000SE1222U	46, 114, 125, 213
0000PN02030	101	0000SE0108B	216	0000SE1308A	112, 212
0000PN02040	88, 89	0000SE0108C	216	0000SE1308B	112, 212
0000PN02060	35	0000SE0115UA	215	0000SE1308C	112, 212
0000PN02069	35	0000SE0115UB	215	0000SE1310A	112, 212
0000PN03012EZ	331	0000SE0125UA	215	0000SE1310B	112, 212
0000PN03016	123, 210	0000SE0125UB	215	0000SE1314A	112, 212
0000PN03040	78	0000SE0204FAZ	336	0000SE1314FT	112, 212

REF.	PAGES	REF.	PAGES	REF.	PAGES
0000SE1322A	112, 212	0000SL2800C	159	0000SM00149U	473
0000SE1322B	112, 212	0000SLA30401	205	0000SM00155U	472
0000SE1322FAZ	336	0000SLA30402	205	0000SM00163	272, 421, 441
0000SE1322FBZ	336	0000SM00030C	162	0000SM00165	272, 421, 441
0000SE1322U	112, 212	0000SM00031U	162	0000SM00165Z	333
0000SE1428A	46, 217	0000SM00032H	162	0000SM00205U	471
0000SE1428B	46, 217	0000SM00038U	132	0000SM00206U	471
0000SE1628U	207	0000SM00039U	162	0000SM00208U	472
0000SE1725UB	165	0000SM00097U	471	0000SM00209U	472
0000SE1815UA	167	0000SM00098U	471	0000SM00210U	473
0000SE1815UB	167	0000SM00100U	471	0000SM00211U	473
0000SE1815UC	167	0000SM00102U	471	0000SM00212U	471
0000SE1815UF	167	0000SM00110U	472	0000SM00213U	284, 404, 447
0000SE2815UA	167	0000SM00111	361	0000SM00214U	285, 405, 447
0000SE2815UB	167	0000SM00112U	471	0000SM00215U	471
0000SE2815UC	167	0000SM00113U	471	0000SM00227D	285, 404, 447
0000SE2815UF	167	0000SM00115U	472	0000SM00228D	285, 404, 447
0000SE3104A	139	0000SM00121U	472	0000SM00244D	460
0000SE3104B	139	0000SM00122U	471	0000SM00244E	460
0000SE3104C	139	0000SM00126	465, 466, 466	0000SM00245D	461
0000SE3104F	139	0000SM00128	482	0000SM00245E	461
0000SE3104FAZ	338	0000SM00129U	471	0000SM00248U	193
0000SE3104FBZ	338	0000SM00130U	472	0000SM00250U	470
0000SE3104FCZ	338	0000SM00139U	472	0000SM00260	424, 444
0000SE3104FFZ	338	0000SM00140U	472	0000SM00286	111
0000SE3815UA	167	0000SM00141U	472	0000SM00297	305
0000SL2601C	160	0000SM00145U	473	0000SM00298	288
0000SL2602C	158	0000SM00146U	473	0000SM00299	193
0000SL2700C	158	0000SM00147FZ	332	0000SM00300	305

Index by item number

REF.	PAGES	REF.	PAGES	REF.	PAGES
0000SM00301	289	0000SP1301E	459	0000TP0005AU	78
0000SM00312	456, 477	0000SP1301E16	459	0000TP0009AU	92
0000SM00401	288	0000SP1310D	459	0000TP0011UA	168
0000SM00402	446	0000SP1310E	459	0000TP0011UB	168
0000SM00600	356	0000SP2410E	460	0000TP0011UC	168
0000SM00602	401	0000SP2510E	460	0000TP0011UF	168
0000SM00603	401	0000TA0001A	33, 44	0000TP0012AU	73
0000SM00606	282	0000TA0030A	82	0000TP0303U	95
0000SM00607	401	0000TA0040A	82	0000TP0309AU	92
0000SM00610	279, 357	0000TA0060A	82	0000TP0312AU	74
0000SM00612	111	0000TA0340A	82	0000TP0312U	331
0000SM00613	111, 305	0000TA0340FZ	331	0000TP0511U	168
0000SM00617	272, 421	0000TA0360A	82	0000TP0909AU	92
0000SM00619	123	0000TA0940A	82	0000TP0912AU	74
0000SM00621	123	0000TA0960A	82	0000VA01010	40
0000SM00632	123	0000TD0010AU	74	00018045A	369
0000SM00640	457	0000TD0020AU	74	00018045B	369
0000SM00643	466	0000TD0120A	100	18070	369
0000SM0131I	361	0000TD0130A	101	18075	370
0000SM0132I	361	0000TD0145A	100	0001C07050D	342
0000SM0133I	361	0000TD0151A	100, 448	0001C07050U1	342
0000SP1200D	458	0000TD0151U	100, 448	0001C07150DC1	342
0000SP1200E	458	0000TD0161A	100, 448	0001C07150DL1	342
0000SP1300D	458	0000TD0320AU	74	0001C07250DB1	342
0000SP1300D16	459	0000TD0320FZ	331	0001C07250DC1	342
0000SP1300E	458	0000TD0500A	104, 152	0001C07250DF3	342
0000SP1300E16	459	0000TD0600A	104, 152	0001C07350DU	342
0000SP1301D	459	0000TD0920AU	74	0001C07450DG1	342
0000SP1301D16	459	0000TP0004AU	78	0001C07450DU	342

REF.	PAGES	REF.	PAGES	REF.	PAGES
0001C08050D	341	000E2037B	56	0020SE1725UB	165
0002TD0552A	102	000E2037C	56	0020SE2742U	279
0002TD0652A	102	000E2037F	56	0022LP0303A	176
0002TD1147A	44	000E2045	56	0022LP1280A	180
0003CO4220D	366	000E6013	52	0022LP1281A	180
00059078A	120	000E6014	52	0022LP1282A	181
00059081A	120	000E6015	52	0022LP1283A	181
00059082A	120	000E6016	52	0022LP1284A	182
00059083A	120	000E6109	52	0022LP1285A	182
00059084A	121	000E6110	52	0022SL2800C	159
00059085A	121	000E6112	52	00BL1000	289, 424, 448
00059086A	121	000E6113	52	00FC0402D00	79
00059087A	121	000EPN01010	209	00FC0402K00	93
0005LP1250A	183	000EPN02011	86, 142	00FC0417K00	93
0005LP1251A	183	000EPN02012	86, 123, 142	00FM0401D00	79
0005LP1252A	184	000EPN03011	86, 142	00FM0401K00	92
0005LP1253A	184	000EPN03012	86, 123, 142	00FM0501D00	79
0005LP1254A	185	000EPN03021	86, 142	00PD04L0A01AA	97
0005LP1255A	185	000EPN03022	86, 123, 142	00PD04L0A01AB	97
0006LP1280A	177	000EPN04011	77	00PD04L0L10AA	97
0006LP1281A	177	000EPN04012	77	00PD04L0L10AB	97
0006LP1282A	178	000EPN06012	77	00PD04L0L30AF	96
0006LP1283A	178	000EPN07011	70	00PD04L0L30BF	96
0006LP1284A	179	000EPN07012	70	00PD04L1L10AA	96
0006LP1285A	179	000EPN07032	70	00PD04S0S00EE	96
0006SL2800C	159	0010SE0628U	207	00PN0309A00DA	85, 141
000E2036	56	002072001U	337	00PN0309A00DB	85, 141
000E2036B	56	0020SE0628U	207	00PN0309A00DC	85, 141
000E2037	56	0020SE0725UB	165	00PN0309A00DF	85, 141

Index by item number

REF.	PAGES	REF.	PAGES	REF.	PAGES
00PN0311N00	167	00PN0513B00	78	00SSSL2601C	163
00PN0323A00DA	85, 141	00PN0513B00E	78	00SSSL2602C	162
00PN0403H00	45, 87	00PN0513D00	80	00SSSL2700C	162
00PN0403H00E	45, 87	00PN0513D00E	80	00SSSL2800C	162
00PN0406B00	78	00PN0603H00	45, 87	00TM0401B00	76
00PN0406C00	71	00PN0603H00E	45, 87	00TM0401C00	69
00PN0406D00	80	00PN0606H00	88	00TM0401D00	79
00PN0406H00	88	00PN0609A00DA	85, 141	00TM0414B00	77
00PN0406K00	94	00PN0609A00DB	85, 141	00TM0414C00	70
00PN0409A00DA	85, 141	00PN0609A00DC	85, 141	00TM0414D00	79
00PN0409A00DB	85, 141	00PN0609A00DF	85, 141	00TM0501B00	76
00PN0409A00DC	85, 141	00PN0613H00	88	00TM0501C00	69
00PN0409A00DF	85, 141	00PN0613H00E	88	00TM0501D00	79
00PN0413B00	78	00PN0623A00DA	85, 141	00TM0514B00	77
00PN0413B00E	78	00PN0803H00	45, 87	00TM0514C00	70
00PN0413C00	71	00PN0803H00E	45, 87	00TM0514D00	79
00PN0413C00E	71	00PN0823A00DA	27, 85	0100LF0030YU	170
00PN0413D00	80	00PN1003H00	45, 87	0100LF0050YU	170
00PN0413D00E	80	00PN1003H00E	45, 87	020P2199906EZ	334
00PN0413H00	88	00PN1023A00DA	27, 85	020P2199907EZ	334
00PN0413H00E	88	00PU0101000	34	03007960A/P	172
00PN0413K00	94	00PU0102000	130	03007965A/P	172
00PN0413K00E	94	00PU0102001	130	0300HA2300U05	410
00PN0423A00DA	85, 141	00PU0102002	130	0300HA3300U05	415
00PN0423A00DB	85, 141	00PU0203000	139	0300HA5300U06	410
00PN0423A00DC	85, 141	00PU0415A00	89, 90	0300HA5300U98	412
00PN0423A00DF	85, 141	00PV0010	494	0300HA5304U06	411
00PN0506B00	78	00PV0031	495	0300HR5300U98	413
00PN0506D00	80	00PV0041	495	0300MA5143U00	378

REF.	PAGES	REF.	PAGES	REF.	PAGES
04007960A/P	172	0EPN0418C00A	70	1090	131
04007965A/P	172	0EPN0418C00B	70	12000A	200
5002	30	0EPN0418K00A	94	13011310	478
05002SF	30	0EPN0418K00B	94	14000A	200
0500HA5301U06	411	0EPN0425A00E	87	1430	130
0500HA5301U98	414	0EPN0426A00	86	16000A	218
0500MA2107U00	377	0ETC0419A00DD	84	172000A	32
0C08414	66	100/5212A	32	172001A	32
0C08414/M	67	100/5213A	32	2000CO4120D	366
0C08420	66	10000A	200	2000CO4220D	366
0C08420/M	67	1000MA8104U00	244	2000MA7101U00	242
0C08511	68	1000MA8125U00	379	2000MA8100U00	232
0C08511/M	67	10200	352	2012	130
0C08512	72	10201	352	2013	131
0EPD04L0L00AA	96	10202	352	2015	150
0EPD04L0L00AB	96	10204	352	2039	56
0EPD04L0L00BB	96	10300	352	2040	56
0EPD04L0L00CC	96	10305	352	2040B	56
0EPD04L0L00FF	96	1053A	148	2040C	56
0EPD04L0L50AA	97	1054	148	2040F	56
0EPD04L0L50AB	97	1057	148	2046	56
0EPD04L5L50AA	97	1059	150	2051A	161
0EPD04L5L50BB	97	1065	150, 168	2051B	161
0EPN0404K00	93	1069E	149	2051C	161
0EPN0412K00	93	1070	148	2051F	161
0EPN0418A00A	87	1084A	129	2060A	157
0EPN0418A00B	87	1085	129	2060B	157
0EPN0418B00A	77	1085A	129	2061A	161
0EPN0418B00B	77	1086	129	2061B	161

Index by item number

REF.	PAGES	REF.	PAGES	REF.	PAGES
2062A	161	21005U	208	24012296	479
2062B	161	21021A	46, 210	2430U	130
2070A	157	21040U	165	2440U	129
2070B	157	23011250	478	2460U	129, 140
2070C	157	23011251	479	2640U	129
2070F	157	23011262	478	2660U	129, 140
2071A	161	23011272	478	2793	210, 211, 214, 220
2071B	161	23011278	481	2795	478
2071C	161	23011282	481	2795/1	479
2071F	161	23011284	481	2797	482
2072A	161	23011285	482	2798	482
2072B	161	23011286	482	3000CO4120D	366
2072C	161	23011289	482	3000CO4220D	366
2072F	161	23011290	482	3000MA8670U00	258
2080A	157	23011291	482	3010	315
2080B	157	23011300	376	30141	309
2080C	157	23011308	482	30300CL	309
2080F	157	23011309	481	30302	310
2082A	161	23011311	482	3036	56
2082B	161	23011314	481	3037	56
2082C	161	23011315	481	3048	218
2082F	161	24011264	481	3054	312
2084A	129	24011266	481	3064	312
2085	129	24011292	481	3072	313
2085A	129	24011293	481	3080	313
2086	129	24011294	481	3082	314
21002	211	24011295	479	3090	314
21003	218	24011298	479	3100	373
21004	214	24011299	479	3105	451

REF.	PAGES	REF.	PAGES	REF.	PAGES
3106	451	3642	302, 319	3667F	350, 319
33011250	478	3644A	305, 311, 320	3667G	350, 319
33011251	479	3644B	305, 311, 320	3667T	350
33011262	478	3645A	351	3669U	124, 463
33011272	478	3645B	351	3671	310
34011274	479	3645C	351	3690U	124, 463
34011276	479	3645E	351	3691U	463
34011283	479	3645F	351	4008A	33, 83, 90
34012301	479	3645G	351	4028AB	33, 83, 90
3600	318	3645T	351	42100A	164
3601	318	3647	319	44011295	480
3604	317	3648A	351	44011295Q	480
3606	317	3648B	351	44011298	480
3607	317	3648C	351	44011298Q	480
3610	318	3648E	351	44011299	480
3611	317	3648F	351	44011299Q	480
3613	318	3648G	351	44012301	481
3614	318	3648T	351	44012301Q	481
3615	317	3650A	473	50002	34
3624	317	3650B	473	50003	34
3626	318	3655	303	50004	34
3633	317	3657	310	50011	34
3635U	463	3659	310	5002SF	30
3637	317	3663CL	317	5002SL	30
3638	310, 318	3665	319	5101	26
3639A	304, 311, 320	3667A	350, 319	5102	26
3639B	304, 311, 320	3667B	350, 319	5104	26
3640	310, 318, 324	3667C	350, 319	5107	26
3641A	302, 319	3667E	350, 319	5111	25

Index by item number

REF.	PAGES	REF.	PAGES	REF.	PAGES
5111/1	25	5181/1	25	5222H	47
5112	25	5182	25	5223	33
5112/1	25	5182/1	25	5224	33
5114	25	5184	25	5225A	32
5114/1	25	5184/1	25	5228A	47
5117	26	5187	26	5229A	47
5126/2	26	5201	29	5231	28
5128/2	26	5201/1	29	5231/PA	28
5136/2	26	5201/21A	29	5233U	122, 140, 209
5138/2	26	5201/28A	29	5234U	122, 140, 209
5141	25	5202	29	5239	33
5141/1	25	5203	29	5240	33
5142	25	5206	34	5241	27
5142/1	25	5210	34	5241/PA	27
5144	25	5211	27	5247	33
5144/1	25	5211/PA	27	5248	43
5147	26	5212A	32	5251	28
5156/2	26	5213A	32	5251/PA	28
5158/2	26	5214	34	5253A	43
5161	25	5215	34	5254A	32
5161/1	25	5216	34	5259A	81
5162	25	5217	34	5260A	81
5162/1	25	5219	34	5261	27
5164	25	5220	34	5261/PA	27
5164/1	25	5221	28	5263A	81
5167	26	5221/PA	28	5264A	89
5176/2	26	5222	47	5271	28
5178/2	26	5222F	47	5271/PA	28
5181	25	5222G	47	5278A	82

REF.	PAGES	REF.	PAGES	REF.	PAGES
5281	27	5807	84	60152C	164
5281/PA	27	5959A	82	60156A	203
5311A	28	5960A	82	60185	345
5329A	47	6000	52	60185A	345
5341A	28	60005/2U	198	60185B	345
5342H	28	60005A	200, 201, 202, 204	60185C	345
5359A	81	6001	52	60185E	345
5360A	81	60057	205	60185F	345
5361A	28	60058	205	60185G	345
5362H	28	60059	205	60193	345
5364A	89	60060	205	60193A	345
5381A	28	60062U	33, 83, 124	60193B	345
5388U	122	60068614	153	60193C	345
5389U	122	60068624	153	60193E	345
5390U	209	60068654	153	60193F	345
54011274	479	60072EZ	337	60193G	345
5411	27	60072U	471	6020A/1-10	55
5411/PA	27	60080U	472	6020A-10	55
5503	30	60082EZ	337	6020B/1-10	55
5511A	28	60082U	471	6020B-10	55
5540	28	60107A	204	6020C/1-10	55
5544	71	60108A	204	6020C-10	55
5560	28	601421	351	6020F/1-10	55
5706	26	601422	351	6020F-10	55
5716	25	601424	351	6020U/1-10	55
5746	25	601425	351	6020U-10	55
5766	25	601426	351	6021	55
5786	25	601428	351	60222	219
5803	84	60152A	164	60230	219

Index by item number

REF.	PAGES	REF.	PAGES	REF.	PAGES
60232	219	6073	55	6310B	57
60233U	311	6074	55	6310C	57
60234	319	6201D	53	6310D	57
6025A	58	6201DA	53	6310F	57
6027F	58	6201DB	53	6320A	57
60294U	211	6201DC	53	6320B	57
60295A	190	6201DF	53	6320C	57
6030	52	6202D	54	6320F	57
60307A	202	6202DA	54	6400B	57
60308A	202	6202DB	54	6400C	57
60311H	202	6202DC	54	6400D	57
6035	53	6202DF	54	6400F	57
60356A	202	6204D	54	64011274Q	479
6036	53	6205D	54	64011276Q	479
60402A	192, 465	6206A	54	7002A	201
60404U	464	6207A	54	7003U	198
60405U	464	6207B	54	7003UA	198
60406Y	192	6207C	54	7003UB	198
6041	59	6207F	54	7003UC	198
6042	59	6208A	54	7003UF	198
6043	59	6211D	53	7004A	199
6047	58	6211DA	53	7004E	199
6048	58	6211DB	53	701421	349, 361
60500	199	6211DC	53	701422	349, 361
60501	199	6211DF	53	701424	349, 361
60502	199	6300B	57	701425	349, 361
60503	199	6300C	57	701426	349, 361
6050A	53	6300D	57	701428	349, 361
6050F	53	6300F	57	701431	349, 361

REF.	PAGES	REF.	PAGES	REF.	PAGES
701432	349, 361	7914A	46, 210	8000A	204
701435	349, 361	7915A	211	8002/1A	203
701436	349, 361	7930AGB	160	8002A	203
701439	349, 361	7930CGB	160	8004A	204
701440	349, 361	7931AGBSS	163	8010	194
7106	321	7931CGBSS	163	801400	343
7108	321	7932AGB	163	8016	194
7151	323	7932CGB	163	8017	195
7152	323	7940AGB	158	8018	196
7153	323	7940CGB	158	8020	195
7154	323	7941CGBSS	162	8024	194
7155	323	7949	47, 125, 210, 211, 214	8032	195
7156	324	7960A	171	8036	196
7157CL	324	7960A/P	171	8040	371
7159	323	7961A	173	8042	369
7160CL	324	7961A/I	174	8042/1	369
7161CL	323	7961A/P	173	8043	451
7163	324	7962A	173	8044	451
7166	324	7962A/I	174	8045A	369
7200	322	7962A/P	173	8045B	369
72000A	31	7963A	189	8049	373
72001A	31	7964A	190	8050	371
72002A	31	7965A	171	8052	476
7230	316	7965A/P	171	8052/1	476
7235	316	7966A	189	8053	375
73000A	31	7970CGB	158	8054	374, 457
7450/2	371	7971CGBSS	162	8054/1	374, 457
79000A	32	7990AGB	160	8055B	375
79001A	32	7990CGB	160	8056DB	375

Index by item number

REF.	PAGES	REF.	PAGES	REF.	PAGES
8057A	475	8079/1	374	8162C	344
8057B	475	8080X	306	8162E	344
8057C	475	8083X	373	8162F	344
8057F	475	8089X	306	8162G	344
8058	376	8090X	307	8167	383
8063	477	8092F	375	8168/1A	346
8063/10	477	8095	483	8168/1B	346
8063/3	477	8098X	307	8168/1U	346, 448
8063/4	477	8107A	215	8168U	407
8063/6	477	8107B	215	8169	344
8063/7	477	8108A	215	8169/1	345
8063/9	477	8108B	215	8169/2	345
8064	478	8108C	215	8169/2A	345
8064/1	478	8112	88	8169/2B	345
8064/3	478	8115U	74	8169/2C	345
8064/8	478	8125AB	65	8169/2F	345
8065A	483	8130AB	74	8169A	344
8066	205	8132AB	74	8169B	344
8068	205	8134	89, 90	8169C	344
8070	369	8136	101	8169E	344
8071	376	8145G	353	8169F	344
8072	376	8149	101	8169G	344
8073B	376	8150	44	8171	382
8074	374	8151	204	8172	382
8075	370	8154	202	8174C	372
8076	370	8162	344	8175	372
8077	370	8162/1	345	8181A	475
8077/1	370	8162A	344	8181B	475
8079	374	8162B	344	8181C	475

REF.	PAGES	REF.	PAGES	REF.	PAGES
8181F	475	8253	310, 318	8440	372
8182A	476	8267	309	8450	372
8182B	476	8269/1	461	8511	67
8182C	476	8272	382	8511/M	67
8182F	476	8331SS	188	8512	71
8191F	373	8332SS	188	8516	68
8200X	308	8335SS	188	8516A	69
8203/2	309	8337SS	188	8516B	69
8205	376	8338SS	188	8516C	69
8205/1	196	8369	344	8516F	69
8205/2	309, 375	8369A	344	8518/M	67
8211/1A	215	8369B	344	8571	382
8211/1B	215	8369C	344	8593	138
8213	311, 320, 325	8369E	344	8594	138
8214U	471	8369F	344	8599	199, 205
8215	196	8369G	344	8601	206
8218A	216	8400A	375	8608/1	205
8218B	216	8400B	375	8611U	311, 319, 325
8218C	216	8400C	375	8613	205
8218F	216	84011298	480	8614	153
8220/1	374	84011299	480	8614.0	153
8220A	311, 325, 374	8414	66	8614D	153
8223U	471	8414/M	66	8614F	153
8225U	311, 320, 325	8420	66	8614GB	153
8227	310, 324, 374	8420/M	66	8615	320
8229U	457	8422	75	8617A	203
8234	309	8422/M	75	8623E	203
8235	471	8423	75	8624	153
8252	310, 318	8423/M	75	8624.0	153

Index by item number

REF.	PAGES	REF.	PAGES	REF.	PAGES
8624D	153	9045	41	9112	126
8624F	153	9078A	120	9120	127
8624GB	153	9079A	120	9121	41
8633A	202	9080A	120	9122	41
8634	154	9081A	120	9131	117
8638A	198	9082A	120	9132	117
8638U	198	9083A	120	9133	117
8640	199	9084A	121	9134	117
8645	200	9085A	121	9135	118
8654	153	9086A	121	9136	118
8654.0	153	9087A	121	9137	118
8654D	153	9088A	121	9138	118
8654F	153	9089/2A	121	9141	117
8654GB	153	9090A	121	9142	117
8730YSS	188	9091	126	9143	117
8731Y	189	9095	126	9144	117
9007	48	9096A	121	9147	45
9008	48	9100	45	9148	209
9009	48	9101	117	9154	48
9020	42	9102	117	9161	118
9021	42	9103	117	9162	118
9022	42	9104	117	9163	118
9025	42	9105	118	9200/PRO	45
9026	42	9106	118	9206A	46, 125
9028	43	9107	118	9214	127
9029	43	9108	118	9215	127
9039	42	9109	45	9216	125
9041	43	9110	126	9217	125
9044	44	9111	126	9271	120

REF.	PAGES	REF.	PAGES	REF.	PAGES
9272	120	9400	45	9593	450
9301	117	94001262	478	9661	119
9302	117	94001298	479	9851	48
9303	117	9401	45	9852	48
9305	118	9402	45	9853	48
9306	118	9451	119	A1110810	201
9307	118	9452	119	A8644A	199
9308	118	9453	119	AU1AW200P0	493
9310	155	9454	119	AU1AW210P0	493
9314	127	9461	120	AU1AW220A0	493
9315	127	9501	117	AU1CR010P0	488
9331	117	9502	117	AU1CR010P7	489
9332	117	9503	117	AU1CR020A0	488
9333	117	9504	117	AU1CR030P0	488
9335	118	9505	118	AU1CR030P7	489
9336	118	9506	118	AU1CR500A0	488
9337	118	9507	118	AU1CR500P0	488
9351	120	9508	118	AU1CS010A0	488
9352	120	9531	117	AU1CS020P0	489
9353	120	9532	117	AU1CS020P7	489
9354	120	9533	117	AU1MD010P0	486
9363	119	9534	117	AU1MR010P0	487
9364	119	9535	118	AU1MR010P7	487
9365	119	9536	118	AU1MR100A0	486
9366	119	9537	118	AU1MR300A0	486
9373	120	9538	118	AU1MR300P0	486
9374	120	9590	449	AU1MR900P0	487
9375	120	9591	449	AU1MR900P7	487
9376	120	9592	450	AU1MS010A0	486

Index by item number

REF.	PAGES	REF.	PAGES	REF.	PAGES
AU1MS020P0	486	C3605CL	317	L0220013	401
AU1MS020P7	487	C3629CL	317	L0220014	401
AU3GA100P0	490	C8201CL	309	L0220015	401
AU3GP020A0	489	HA0603002U000	414	L4220013	401
AU3GP100P0	490	HA0603003U000	416	L4220014	401
AU3GP100P7	490	HA0603004U000	418	L4220015	401
AU3GP200P0	489	HA0603005U000	415	L5220013	401
AU3GP200P7	490	HA0648003U000	419	MA0001000U000	235
AU3KA100V7	495	HA0648005U000	418	MA0001003U000	228
AU3KP100V7	494	HA5503006U000	413	MA0001101U000	231
AU3SP100P0	490	HA5603003U000	417	MA0101003U000	226
AU5HP300P0	491	HR0603003U000	416	MA0101406U000	235
AU5HP310P7	491	HR0603006U000	417	MA0201000U000	239
AU5MA010A0	491	I1050072	278	MA0301002U000	232
AU5MA010V0	491	I1050073	467	MA0306702UD00	253
AU5MA100A0	491	I1050074	467	MA0401402U000	237
AU5MA100P0	492	I1050075	467	MA0401405U000	236
AU5MA200P0	492	I1050076	467	MA0406700U000	250
AU5MA500P0	492	I1051074	467	MA0501415U000	238
AU5MP010A0	492	I1051075	467	MA0506702U027	251
AU5MP010V0	492	I1051076	467	MA0506711U000	252
AU9C0004P0	494	I1052073	467	MA0601019U000	233
AU9PAC1000	493	I1052074	467	MA0701404U000	244
AU9PRS1020	493	I1052075	467	MA0701450U000	243
AU9PRS1021	493	I1052076	467	MA0701500U000	243
C30075CL	309	I1900011	457	MA0706800U000	255
C30139CL	309	I1900050	402	MA0706804U000	256
C30140/2	309	I2190039	208	MA0706806UD00	256
C30152	196	I2190044	214	MA0706855UD00	257

REF.	PAGES	REF.	PAGES	REF.	PAGES
MA0801114U000	248	MA5601416U000	240	P064000A	302, 400
MA0801407U000	246	MA5801408U000	245	P064000U	302, 400
MA0806708U000	260	MA5806703U000	260	P065060U	270, 400, 420
MA0806732UD00	262	MA5806709UD00	263	P066011U	269, 420
MA0806803U000	258	MR0601400U017	242	P066031U	269, 420
MA0806819U000	261	MR0806703U000	259	P066061U	269, 420
MA0848703U000	267	MR3606701U000	254	P066231Q	439
MA0901005U002	380	MR3801400U000	245	P066251Q	439
MA0901006U000	378	MR3806814UD00	264	P066281Q	439
MA0901019U000	380	MX0236704U000	266	P074000A	302
MA2606701U000	252	MX3336700U007	266	P074000U	302
MA3301000U000	231	MZ0503700Z900	328	P075060Q	440
MA3306700U000	253	MZ0603700Z900	328	P075060U	270
MA3601400U000	241	MZ0603706Z901	329	P075130Q	440
MA3606718U000	255	MZ0803701Z900	329	P104001D	460
MA3801000U001	233	MZ0803705Z901	330	P104001E	460
MA3801400U002	246	MZ3803702Z900	330	P104002D	460
MA3801500U000	247	P0190047UA	208	P104002E	460
MA3806701U002	257	P0190047UB	208	P104003D	460
MA3806710UD00	264	P0190049U	208	P104003E	460
MA3806711UD00	265	P019004U	299	P110004A	110
MA3806719U000	261	P025011U	269	P110014U	110
MA3806780U000	259	P025031U	269	P114011A	190
MA3806781UD00	263	P025061U	269	P114021U	456
MA3806809UD00	262	P059011U	269, 420	P119001A	300
MA3848400U002	267	P059031U	269, 420	P119001U	300
MA3848711UD00	268	P059061U	269, 420	P119002A	300
MA4601400U000	241	P059361UX	269	P119002U	300, 406
MA4801400U002	247	P06000	121	P119003A	300

Index by item number

REF.	PAGES	REF.	PAGES	REF.	PAGES
P119003U	300	P159131Q	439	P190060F	354
P1190041U	112, 213	P159141Q	439	P190060U	354
P1190042FZ	339	P159261Q	439	P190061H	355
P1190042U	112, 213	P165000EZ	332	P190071D	343
P1190043A	47	P165000Q	440	P190071U1	343
P1190044U	218	P165000U	270, 400, 420	P190072D	343
P1190048UB	209	P165001U	270	P190072U1	343
P1190050U	218	P166031EZ	332	P190073DC1	343
P119008U	305	P166031U	269, 420	P190073DL1	343
P1191100EZ	334	P166061Q	439	P190074DB1	343
P1191100U	275, 407, 424, 448	P166081Q	439	P190074DC1	343
P1199900U	276	P166131Q	439	P190074DF3	343
P120004E	191	P166141Q	439	P190075DU	343
P120007A	192, 466	P166261Q	439	P1901109U	269
P120008A	193, 466	P175000Q	440	P1901112U	283
P1220203E	302	P175000U	270, 420	P1901113U	465, 466, 466
P1228802Q	443	P1780010	201	P190208U	473
P1229900U	280, 423	P1780011U	198	P190209U	473
P1229906FZ	335	P1780029U	200	P190301H	163
P1229906U	113, 281, 401, 444	P179001A	465, 466, 466	P190350E	112, 213
P1229906UX	281	P179002A	192, 465, 466, 466	P190350FZ	339
P1229907FZ	335	P179040A	132, 147	P190360U	114, 283, 336
P1229907U	281, 401, 444	P179080U	461	P190371H	163
P1229907UX	281	P190010E	468	P190600A	483
P1229909U	113, 281, 401, 444	P190020U	468	P190600U	483
P130001Q	468	P190060A	354	P190610Q	483
P159061Q	439	P190060B	354	P190610U	483
P159061U	269, 420	P190060C	354	P190611U	483
P159081Q	439	P190060D	354	P1908839E	441

REF.	PAGES	REF.	PAGES	REF.	PAGES
P190908U	287, 304, 338, 355	P1909948EZ	337	P202001A	298
P190914A	360	P1909948U	288	P202002A	298
P190914B	360	P1909957U	284, 303, 446	P202008U	399
P190914C	360	P1909961U	113, 285	P202012U	399
P190914F	360	P1909966U	280	P202017A	298
P190914I	360	P1909967U	277	P202050A	298
P190915I	359	P1909968U	277	P202051U	399
P190916A	287	P191000T	104, 113, 140	P202053A	298
P190920U	301	P191021T	104	P202058U	399
P190921U	301	P191045T	104	P202063U	399
P190926D	349	P191061U	33	P202067A	298
P190927U	457	P191068U	83, 124	P202075U	399
P190928U	456	P191069U	83, 124	P2031102U	270
P190937D	349	P191070U	83, 124	P2031103U	271
P190938D	344	P191071U	83, 124	P2038805E	440
P190972D	368	P191077U	83, 124	P2038806E	440
P190973D	368	P191084A	104	P2038807E	441
P190974D	367	P191085U	83, 124	P2038808E	441
P190975N	368	P191104H	83	P2039903E	271, 420
P1909901U	470	P191105H	83	P2039903EX	271
P1909914U	284	P191106H	83	P2039903FZ	333
P1909925U	113, 285	P191107H	83	P2039904E	271, 420
P1909926U	284	P191108H	83	P2039904FZ	333
P1909927U	284	P191109H	83	P2039906E	272
P1909932U	219	P1918802E	441	P2039908E	271, 421
P1909933U	113, 285	P1919969U	470	P2039909E	272
P1909937EZ	336	P192000T	104, 113, 140	P2059963E	274
P1909937U	281	P1929969U	470	P206002A	189
P1909940U	464	P1948802E	441	P206003A	190

Index by item number

REF.	PAGES	REF.	PAGES	REF.	PAGES
P206010E	190	P2229906FZ	335	P2400D2C	155
P206020U	283, 303, 445	P2229906U	281, 401, 445	P2400D3C	155
P206030U	283, 303, 445	P2229906UX	281	P2400D4B	155
P206040U	283, 303, 445	P2229907FZ	335	P2400F3C	155
P210017TA	110	P2229907U	281, 401, 445	P2400F4B	155
P210017TB	110	P2229907UX	281	P240GB1C	155
P210022TA	110	P2229909U	281, 401, 445	P240GB2C	155
P210022TB	110	P2229910Q	444	P240GB3C	155
P219004U	405	P2229911Q	444	P240GB4B	155
P219005U	405	P2229911U	424	P250001C	154
P219007U	463	P2229913U	280	P250002	154
P2191101U	463	P2229914U	280	P2780030	201
P2191102U	463	P224002E	191	P2780040	201
P2191103U	463	P225004A	192, 465	P2780060	200
P2199906U	274, 422	P225005U	465	P278006A	201
P2199907U	274, 422	P225006I	362	P281001E	190
P2199926U	274, 422	P230001B	155	P290068E	279, 357
P2199926UT	274, 422	P230001Q	468	P290074DG1	343
P2199927U	275, 423	P230002A	155	P290074DU	343
P2199927UT	275, 423	P230003C	155	P290800A	192, 465, 466, 466
P2199936U	274, 422	P2300D3C	155	P2908820Q	443
P2199936UT	274, 422	P2300F3C	155	P2908821Q	443
P2199937U	275, 423	P230GB3C	155	P2908822Q	443
P2199937UT	275, 423	P2328801Q	443	P2908823Q	443
P220001E	191	P240001C	155	P290914A	360
P2228800Q	442	P240002C	155	P290914B	360
P2228803Q	443	P240003C	155	P290914C	360
P2229906A	281, 401, 445	P240004B	155	P290914F	360
P2229906B	281, 401, 445	P2400D1C	155	P290914I	360

REF.	PAGES	REF.	PAGES	REF.	PAGES
P290929A	457	P2909921EZ	335	P291920U	286, 304, 405, 424
P290929B	457	P2909921U	276, 423	P291920UA	286, 304, 405, 424
P290929C	457	P2909921UX	276	P291920UB	286, 304, 405, 424
P290929F	457	P2909934E	299	P2919943U	287
P290934A	349	P2909946A	287	P299001C	469
P290934B	349	P2909946B	287	P3038804E	440
P290934C	349	P2909946FZ	338	P3059953E	272, 421
P290934D	349	P2909955A	287	P3059953EX	273
P290934E	349	P2909955B	287	P3059954E	273, 421
P290934F	349	P2909960U	276	P3059954EX	273
P290934G	349	P2909962U	286	P3059967E	274
P290976A	367	P2909966U	280	P3059974E	273, 421
P290976B	367	P291029A	103	P3059977E	422
P290976C	367	P291029B	103	P306010A	190
P290976D	367	P291029C	103	P306020U	283, 303, 446
P290976F	367	P291029F	103	P314001U	399
P290977D	367	P291030A	103	P314005U	399
P290978D	367	P291030B	103	P3199903EZ	334
P290979D	367	P291030C	103	P3199903U	275
P290981D	367	P291030F	103	P3199903UA	275
P290989D	367	P291050H	90	P3199903UB	275
P2909912EZ	335	P291051H	90	P3199903UC	275
P2909912U	284	P291070E	356, 279	P3199903UF	275
P2909915U	286	P291918A	286, 304	P3199903UX	275
P2909918FZ	338	P291918B	286, 304	P3199905U	275
P2909918U	286	P291918FZ	338	P3199905UA	275
P2909920EZ	334	P291919A	286, 304, 446	P3199905UB	275
P2909920U	276	P291919B	286, 304, 446	P3199905UC	275
P2909920UX	276	P291919T	286, 304, 446	P3199905UF	275

Index by item number

REF.	PAGES	REF.	PAGES	REF.	PAGES
P3199908U	422	P3909955B	287	P816010U	300, 404
P3199928U	423	P3909962U	286	P8161110U	277
P3199938U	423	P3909966U	280	P8161111U	277
P320100UA	110	P391070E	356, 279	P8161111UX	277
P320101UA	110	P3928802E	442	P8161112U	277
P320200UA	110	P3938802E	442	P8161113U	277, 423
P320201UA	110	P3958802E	442	P8161114EZ	335
P3228800QU	442	P3968802E	442	P8161115U	277, 423
P3228801QU	443	P402050U	298	P8168800Q	444
P3229915U	284, 444	P402053U	298	P8168801Q	444
P390300C	163	P402067U	298	P8168802Q	444
P3908833Q	443	P406020U	283, 303, 446	P8168803Q	444
P3908834Q	443	P414001U	399	P8169900U	277
P3908835Q	443	P414005U	399	P8169901U	277
P3908836Q	443	P4199903U	275	P8169903U	278
P390914A	360	P4199903UA	275	P8169904U	278
P390914B	360	P4199903UB	275	P8169905EZ	335
P390914C	360	P4199903UC	275	P8169905U	278
P390914F	360	P4199903UF	275	P8169906U	278
P390914I	360	P514000U	399	P8268800Q	443
P390986D	367	P514005U	399	P8268801Q	443
P390987D	367	P515010U	269	P8268802Q	443
P3909915U	286	P515030U	269	P8268803Q	443
P3909918U	286	P515060Q	439	P8269907U	278
P3909952E	273	P515060U	269	P906010U	300
P3909952FZ	334	P515130Q	439	PA50028N	461
P3909953FZ	333	P516010U	300, 404	Q0400070G	403
P3909954FZ	333	P606010A	190	Q0400073Q	447
P3909955A	287	P716010U	300	Q0400075G	403

REF.	PAGES	REF.	PAGES	REF.	PAGES
Q0400101G	403	R1030113	400	R2050010	305
Q0400102G	403	R1030122	400	R2060010	301
Q0400103G	403	R1030125	299	R2060031	278
Q0400104	406	R1030134	299	R2060080	407
Q0400105A	103	R1030137	298	R2060081	404
Q0400106B	103	R1030142	400	R2180085	445
Q0400107A	103	R1030144	400	R2180400	350, 364
Q0400108	103	R1030146	400	R2200040	282, 407
Q0400117	406	R1030147	298	R2200041	301
Q0400122P	403	R1040010	282, 301	R2200045	114, 283
Q0400131E	456, 476	R1050040	193	R2200050	407
Q0400132E	456, 476	R1050050	193	R2200051	407
Q0400220G	405	R1180050	406	R2200120	301
Q0400221G	405	R1180080	448	R2240030	464
Q0400230G	405	R1200020	301	R2240040	464
Q0400231G	405	R1200042	282	R3030135	407
Q1400010G	402	R1200044	282	R3030162	115, 282
Q1400011E	402	R1200103	191	R3090	314
Q1400030G	402	R1200104	191	R3659	301
Q1400050G	403	R1200113	191	R7230	316
Q1400090G	402	R1200114	191	R7235	316
Q1400110G	402	R1230110	400	R8017	195
Q1400118U	406	R1230111	400	R8024	194
Q1400123E	445	R1230112	400	R8061/1	189
Q1400130G	402	R1230113	400	R8061/2	189
Q1400210G	402	R1900050	406	R8090	307
R1030010	298	R2030106	406	R8098	307
R1030040	299	R2030120	115, 302	R8218	192
R1030103	299	R2030161	400	R8377	371

Index by item number

REF.	PAGES	REF.	PAGES	REF.	PAGES
R9156	455	SE0304020PE00	437	TCE101010	134
R9157	455	SE0305020AE00	429	TCE101019	134
R9158	455	SE0305020PE00	438	TCE101020	134
R9159	456	SE0305021AE00	430	TCE101029	134
R9166	453	SE0306020AE00	431	TCE101030	134
R9167	454	SE0306021AE00	432	TCE101039	134
R9168	454	SE0316020AE00	434	TCE101040	134
R9169	454	SE0317020AE00	433	TCE101049	134
R9176	452	SE0318021AE00	433	TCH101010	135
R9177	452	SE0400020PE02	437	TCH101019	135
R9178	453	SE0401021AE00	427	TCH101020	135
R9179	453	SE0404021AE00	429	TCH101029	135
R9256	455	SE0505021AE06	430	TCH101030	135
R9257	455	SE0506021AE00	432	TCH101039	135
R9266	453	SE0605021AE00	431	TCH101040	135
R9267	454	SLP015000001D	355	TCH101049	135
R9276	452	SLP015000001U	355	TCH101120	137
R9277	452	SLP015000004D	355	TCH101129	137
SAC025	37	SLP015000004U	355	TCH101210	135
SE0000020AE01	436	SLP015000007H	355	TCH101219	135
SE0104020AE01	436	SLP015000009H	355	TCH101220	135
SE0105020AE00	434	SLP036000001A	198	TCH101229	135
SE0105021AE00	435	SLP036000001B	198	TCH101230	135
SE0106020AE00	435	SLP036000001C	198	TCH101239	135
SE0300020AE00	426	SLP036000001F	198	TCH101240	135
SE0301020AE00	426	SLP036000001U	198	TCH101249	135
SE0301021AE00	427	SLP036000003U	198	TCH101410	135, 331
SE0304004AE00	428	TA50029	461	TCH101419	135, 331
SE0304020AE00	428	TA50066	461	TCH101420	135, 331

REF.	PAGES	REF.	PAGES	REF.	PAGES
TCH101429	135, 331	TCH201020	134	TCH603049	137
TCH101430	135, 331	TCH201029	134	TCH803000	138
TCH101439	135, 331	TCH201030	134	TCH803009	138
TCH101440	135, 331	TCH201039	134	U100007	201
TCH101449	135, 331	TCH201040	134	U100017	198
TCH101510	135	TCH201049	134	V1010801	200
TCH101519	135	TCH201120	136	V190062	356
TCH101520	135	TCH201129	136	V2030122	115, 288, 303
TCH101529	135	TCH401010	136	V2060103F	374
TCH101530	135	TCH401019	136	V2060104F	374
TCH101539	135	TCH401020	136	V250004H	154
TCH101540	135	TCH401029	136	V8618	203
TCH101549	135	TCH401030	136	V8632	202
TCH102020	137	TCH401039	136	V8643	199
TCH102029	137	TCH401040	136	Z2060103	374
TCH103020	136	TCH401049	136	Z2060104	374
TCH103029	136	TCH404030	137	Z30130	206
TCH104010	134	TCH404039	137	Z30131	206
TCH104019	134	TCH601010	136	Z30132	206
TCH104020	134	TCH601019	136	Z30133	206
TCH104029	134	TCH601020	136		
TCH104030	134	TCH601029	136		
TCH104039	134	TCH601030	136		
TCH104040	134	TCH601039	136		
TCH104049	134	TCH601040	136		
TCH120020	138	TCH601049	136		
TCH120029	138	TCH602030	137		
TCH201010	134	TCH602039	137		
TCH201019	134	TCH603040	137		

General information

The items manufactured and sold by Filmop® International Srl satisfy all safety requirements and are suitable for use.

Data, weights, descriptions and images of the single articles contained in this catalog are indicative.

Filmop® International Srl, whose policy aims at continuous improvements, reserves the right to make all the necessary changes without notice and at any moment to its products.

The images, photos, drawings and any other representation of Filmop® International Srl products, whether contained or not in catalogues, price lists, brochures and in any advertising material, belong exclusively to Filmop® International Srl and, therefore, cannot be used in any form or in any way by customers or third parties without a specific written authorization by Filmop® International Srl.

The commercialization or advertising of Filmop® International Srl products in any way or by any means by customers or third parties cannot be made anonymously, but must always show Filmop® International Srl logo, unless otherwise authorized by Filmop® International Srl .

Filmop® International Srl trademark on products or in advertising material cannot ever be erased, covered or made invisible.

Any customer's trade mark may be added to Filmop® International Srl logo, but avoiding any confusion concerning the identity of the manufacturer of the goods.



www.filmop.com



FILMOP INTERNATIONAL s.r.l.
(Soc. a Socio Unico)

Via dell'Artigianato, 10/11
35010 VILLA DEL CONTE (PD) - ITALY
Tel. +39 049 9325066 - Fax +39 049 9325317
www.filmop.com - filmop@filmop.com
Reg. Imp. di PD / C.F.: 04848400281
R.E.A.: PD n° 423341

Cod. ISO / VAT / P.IVA: IT 04848400281
Cap. Soc. € 6.000.000 int. vers.

Filmop International_Cod.803_032023

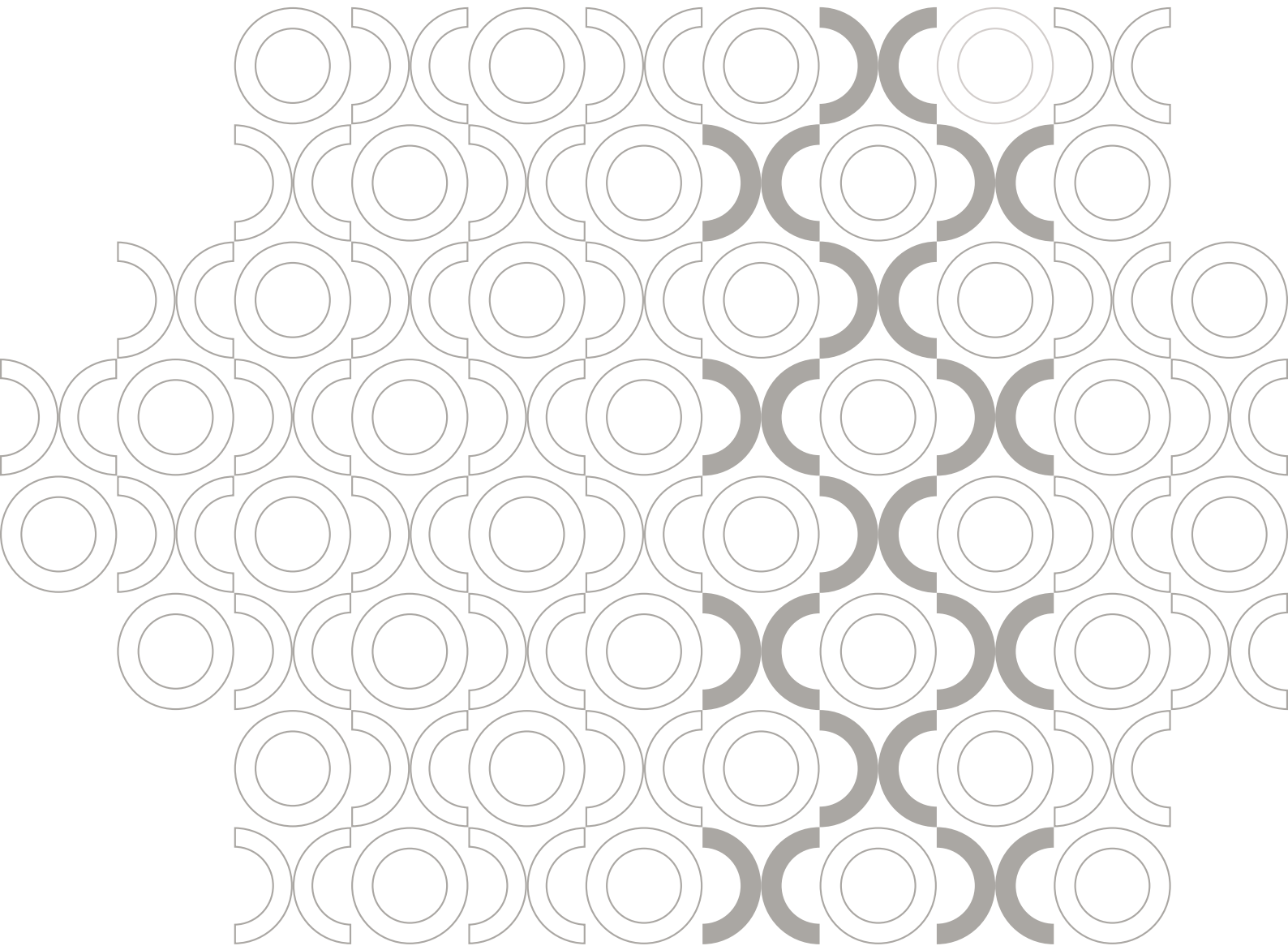

Product certification
valid for a range of
plastic products



Product certification
valid for a range of
textile products

Distributor